

H Series Micro

Plug-in valve island

PDE2597CUK



ENGINEERING YOUR SUCCESS.

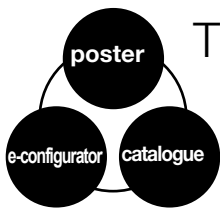

The machine designer H Series Micro workshop

Valves are the centre of electro-pneumatic automation. They are now designed into compact islands that are easily configured to each application.

For full efficiency in this enhanced automation practice, machine designers are helped by 3 complementary design tools :

- 1 - The H Series Micro valve island **e-configurator** and **3D models** are available on website:
<http://www.parker.com/pneu>
- 2 - The H Series Micro functional **poster**
- 3 - This **catalogue**, including technical data and ordering guide



Important !

Before carrying out any service work, ensure that the valve and manifold have been vented. Remove the primary supply air hose to ensure total disconnection of the air supply before dismantling valves or blank connection blocks.



NB !

All technical data in this catalogue is typical only. The air quality is decisive for the valve life: see ISO 8573.



WARNING

FAILURE OR IMPROPER SELECTION OR IMPROPER USE OF THE PRODUCTS AND/OR SYSTEMS DESCRIBED HEREIN OR RELATED ITEMS CAN CAUSE DEATH, PERSONAL INJURY AND PROPERTY DAMAGE.

This document and other information from Parker Hannifin Corporation, its subsidiaries and authorized distributors provide product and/or system options for further investigation by users having technical expertise. It is important that you analyze all aspects of your application and review the information concerning the product or system in the current product catalog. Due to the variety of operating conditions and applications for these products or systems, the user, through its own analysis and testing, is solely responsible for making the final selection of the products and systems and assuring that all performance, safety and warning requirements of the application are met. The products described herein, including without limitation, product features, specifications, designs, availability and pricing, are subject to change by Parker Hannifin Corporation and its subsidiaries at any time without notice.

SALE CONDITIONS

The items described in this document are available for sale by Parker Hannifin Corporation, its subsidiaries or its authorized distributors. Any sale contract entered into by Parker will be governed by the provisions stated in Parker's standard terms and conditions of sale (copy available upon request).

Pages

Intoduction

4 to 11

Product presentation

Ordering guide

12 to 25

Valve island components

Manifold components

14 & 15

Fittings and accessories

16 & 17

H Series Fieldbus Components

Multi-connection ends kit

18 & 19

H Series Fieldbus 32 output driver ends kit

20 & 21

Valve Driver Module to TURCK BL67 adaptor

Valve Island end kits, 16 Outputs & Blank modules

22 & 23

Communication gateways, Electronic and base modules, Power Feeding modules

24 to 27

Moduflex Bus components

Valve island, end kits, Fieldbus modules and accessories

28 & 29

Multi-pole connection components

Sub-D25 end kits and cables

30 & 31

Dimensions

32 to 35

Installation and Service

36 to 40

Valve Islands for centralized application

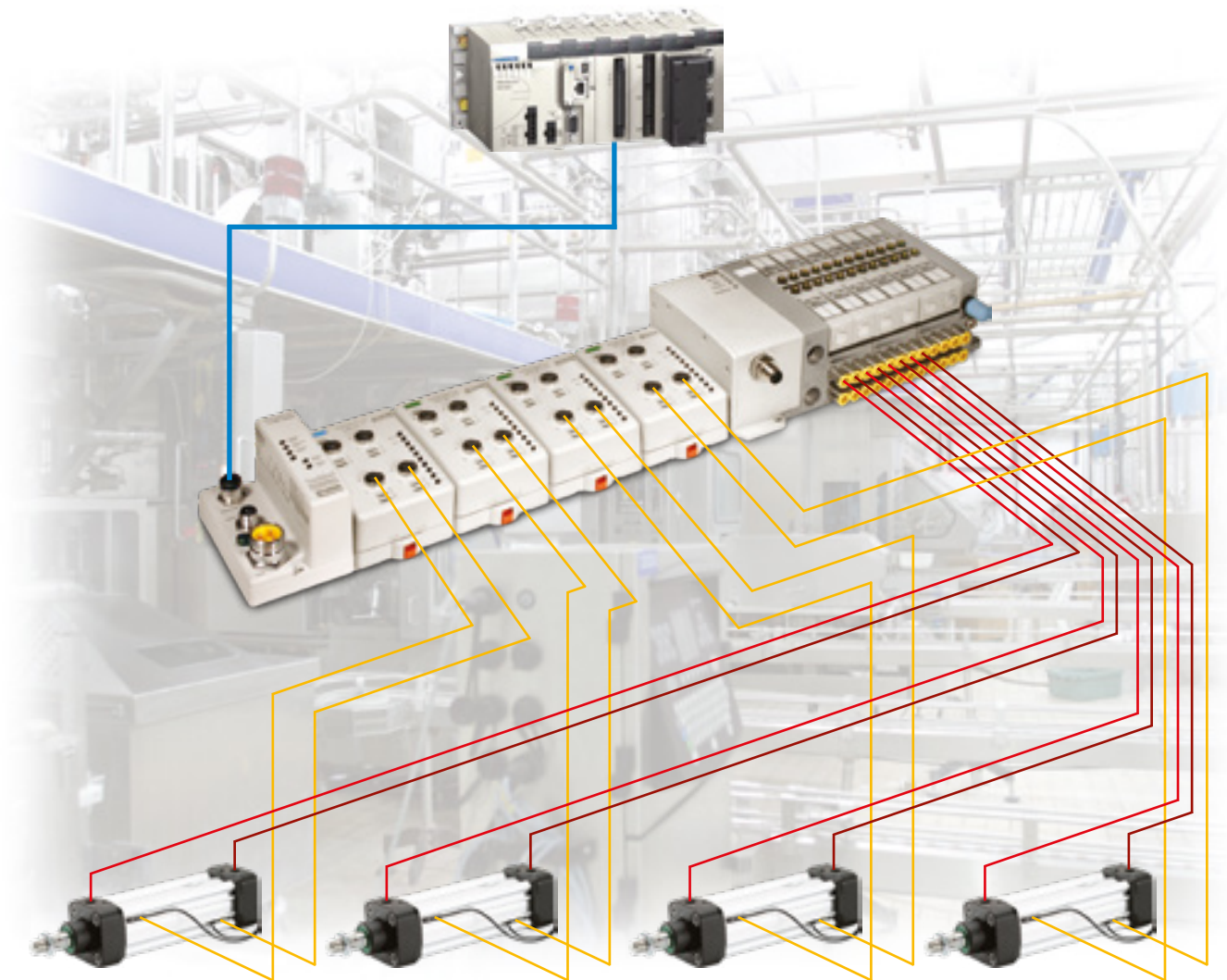

Valve islands for centralized application

Depending upon the machine configuration and design, all of the pneumatic actuators may be controlled from a centralized control panel complete with all the necessary pneumatic valves. The control valves would normally be grouped together into a 'valve island' enabling the solenoids to be electrically interconnected and in turn linked to a PLC via an industrial network. In this configuration all the

sensors can be connected to either remote devices positioned around the machine or back to the centralized panel and signals transmitted to the PLC via the valve island and industrial network. Other digital or analogue I/O can be connected if required.

Valve Islands for decentralized application

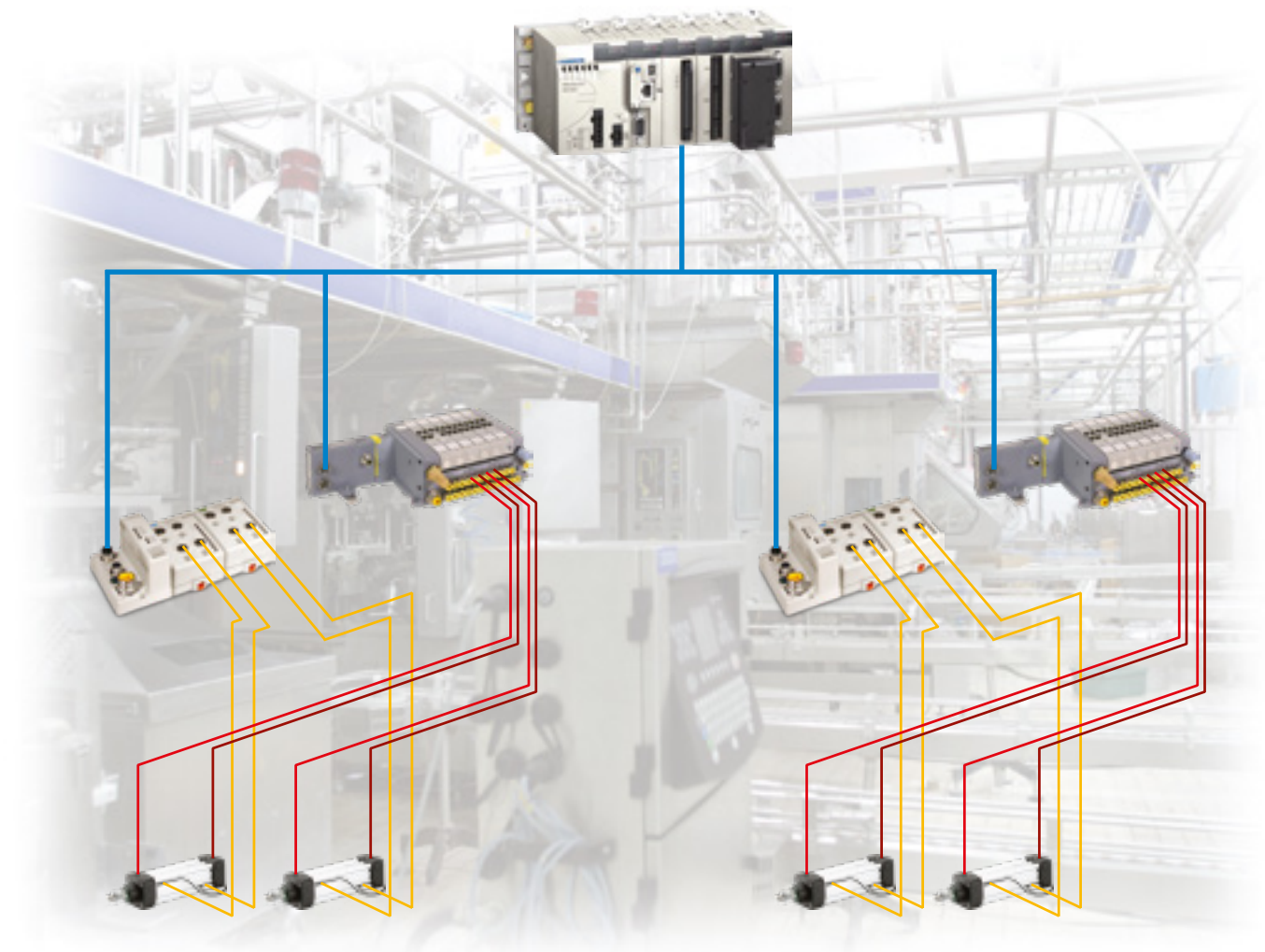

Valve islands for decentralized application

On larger machines where pneumatic actuators are distributed around the machine, a better solution may be to position smaller 'valve islands' closer to groups of actuators. This enables shorter runs of pneumatic tubing and can result in reduced air consumption and improved cycle times.

Other digital or analogue I/O can be connected to the remote devices or directly to the PLC. All devices can be connected to the PLC using traditional wiring, multi-pole connection or an industrial network.

The H Series Micro valve redefines flexibility for pneumatic users. When either configured from basic components or ordered as pre-assembled and tested valve islands, H Series Micro valves are the answer to all your needs.



Solenoid operated Valve fitted with 24 VDC solenoids

Plug-in valves

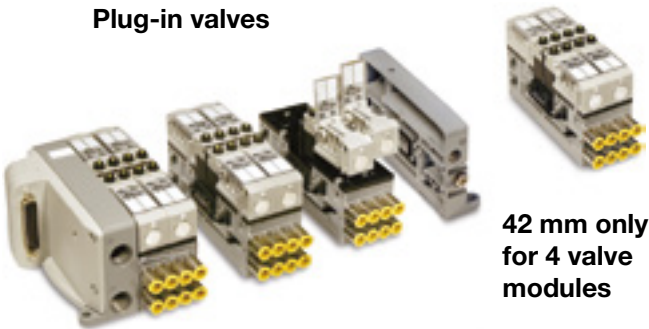

42 mm only for 4 valve modules

- Up to **8 pneumatic functions** on a **42 mm width** metal sub-base manifold.
- 4 valve modules **back to back** mounted for a compact design.
- Optimized flow with 6 mm OD tube allows 0,5 m/s speed on a 50 mm diameter cylinder with 1/4 fittings.

Optimized flow for a 6 mm OD tube

Qn = 282 NI/mn Qmax = 510 NI/mn

Side ported manifold design



- Manifold with common ducts for ports 1, 3 and 5, outlet port 2 and 4, and supply port for 12 and 14 are available side ported.

Bottom ported manifold design



- A bottom ported design for an easy integration into an enclosure.

An easy man-machine dialogue

• Multifunction manual override

Standard non-locking manual overrides can be easily changed to locking or blocked with accessories available with valves.

• Customer identification

Have your own identification on the product protected with a transparent flip-up cover.

A quick visual diagnostic face

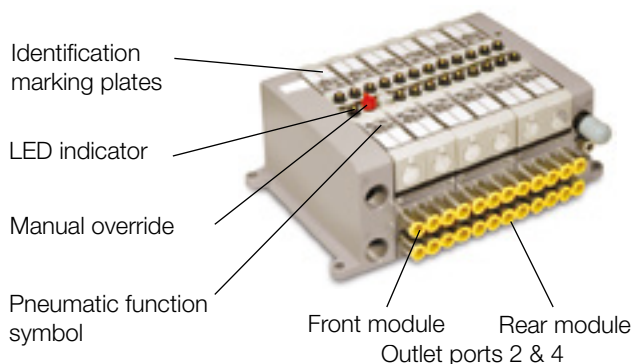

H Series Fieldbus : A centralized Fieldbus and Industrial Ethernet system

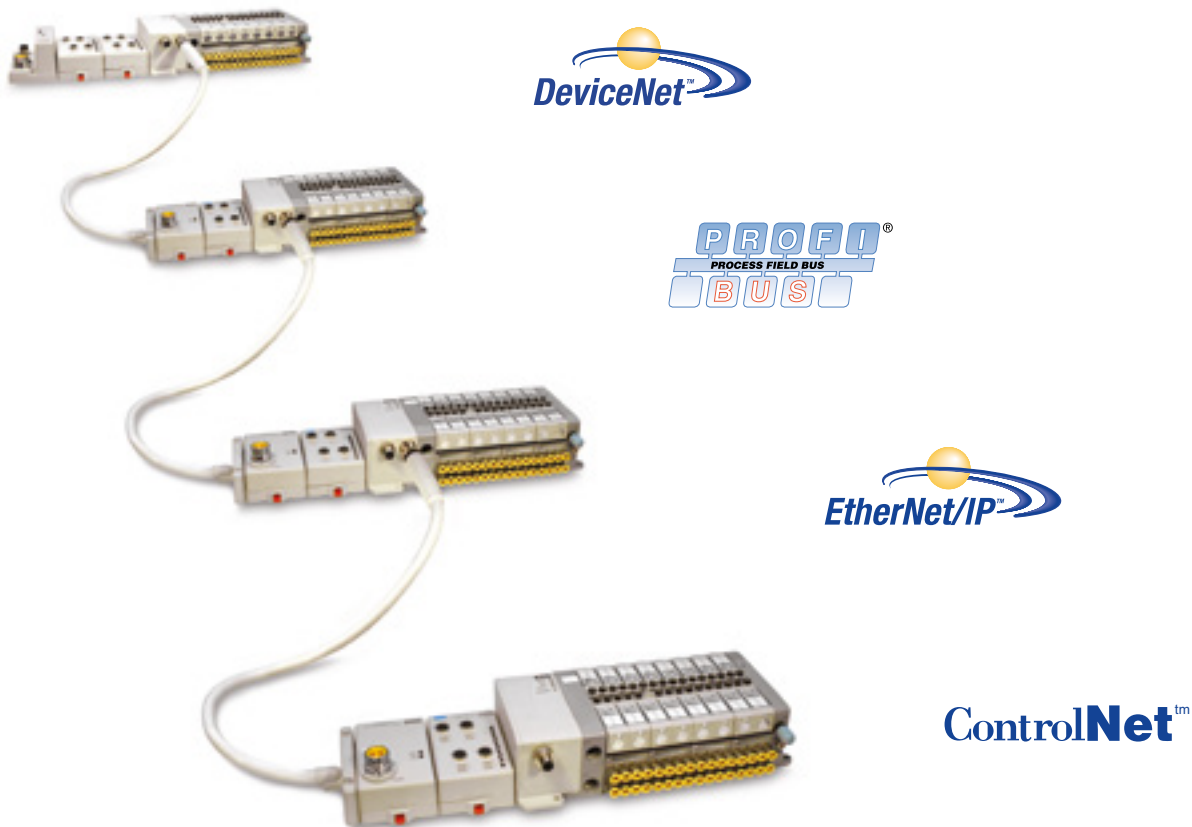

Integrated Solution

- A large Fieldbus and Industrial Ethernet communication offering for all H Series Micro range.
- Extremely fast I/O backplane uses change-of-state (COS) connections to maximise performance.
- UL, C-UL and CE certifications (as marked).

Modularity

- Ease of module replacement with unique latching mechanisms eliminating the need for screws.
- Auto Device Replacement allows OEMs to add I/O modules without making changes to the control software.
- Built-in panel grounding.
- Electronic and mechanical keying prevents users from placing I/O modules in the wrong sequence.

Communication Modules

- A Communication Module supports up to 63 I/O modules and up to 256 Inputs and 256 Outputs.

I/O Modules

- Accepts signals from sensors, photo eyes, limit switches and other field input devices.
- Provides signals to remotely operating solenoid valves and other field operating output devices.
- Choice of digital, analogue, high watt I/O Modules.
- Choose from a broad range of colour coded I/O types with connector choices of M8, M12 or M23.
- Built-in miswiring, short circuit, open circuit detection with electronic feedback.



Flexible in use
 The H Series Micro range is fully dedicated to centralized applications where a high quantity of valves have to be concentrated in a single location.

Solenoid valve island can also be implemented with digital or analogical electrical I/O.

From a centralized application high complexity level to a basic configuration, with industrial communication or traditional multi-connection, an H Series Micro valve island can be designed.

One communication module for 256 Inputs and 256 Outputs

The combination of 32 output drivers and electrical I/O modules linked to the main communication module allows H Series Micro valve islands to drive up to 512 I/O, including up to 128 solenoids split between 4 interconnected devices.

Both electrical inputs and outputs modules can also be assembled either on the main or extended islands.

Expansion power supply may be used to provide additional Pointbus backplane current.

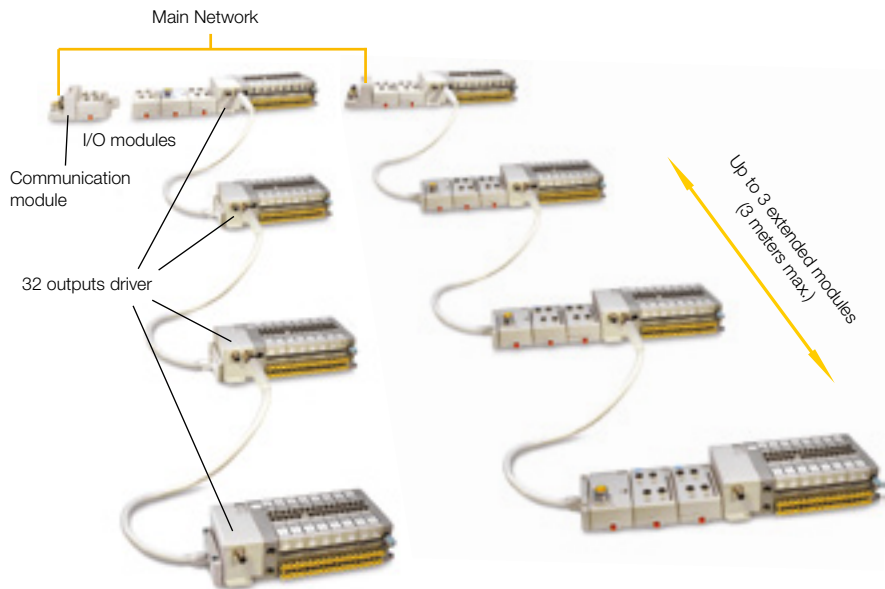

Up to 128 solenoid valves configuration

If a high quantity of valves is required in a centralized application, up to 3 extended islands can be connected to the main device communication module.

All extended islands are connected through a bus extension cable PSSVEXT1 (including 1 m cable and head plate).

In this configuration, the 32 outputs driver module, on the main island and the extended island, have to be equipped with a "bus extension" M12 connector, excepted for the last extended island.

All 32 outputs driver modules need to be equipped with a M12 solenoids power supply connector.

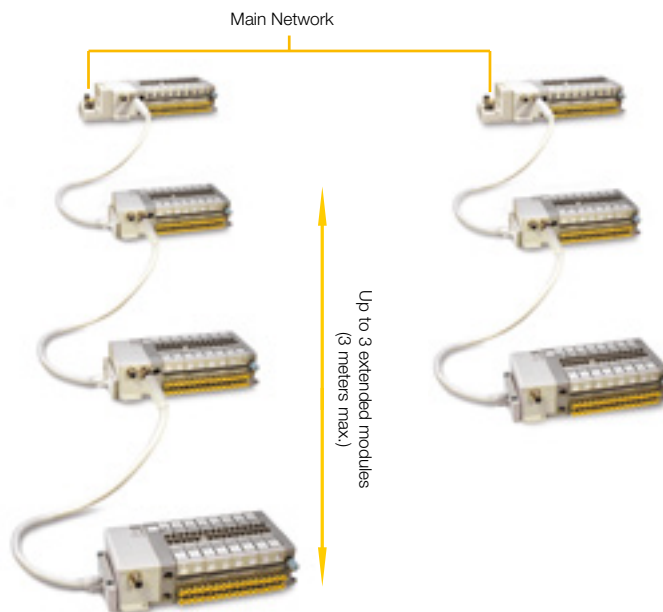

Up to 256 electrical outputs including 32 solenoid valves

Communication modules include a main 24 VDC power supply for the Bus and up to 10 digital or analogical output modules. Additional power supply is only requested if there are more than 11 output modules.

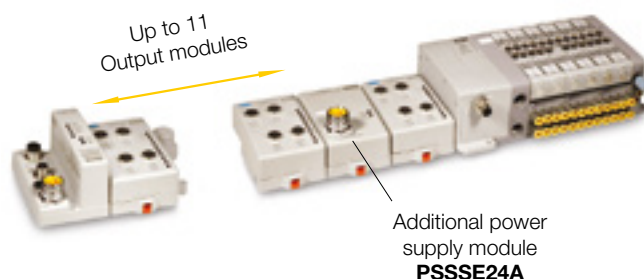

Up to 32 solenoid valves

Communication modules include a main 24 VDC power supply for the bus and the 32 output driver modules. All solenoids can be energized at the same time.



Island up to 16 or 32 solenoid valves linked to the Turck BL67 remote I/O device series

 This electro-mechanical interface allows, with its modularity up to 16 or 32 solenoid valves, an inter-connection to the TURCK BL67 Series, offering a wide choice of industrial communication with Field bus and Industrial Ethernet protocols and a complete range of electrical I/O modules.

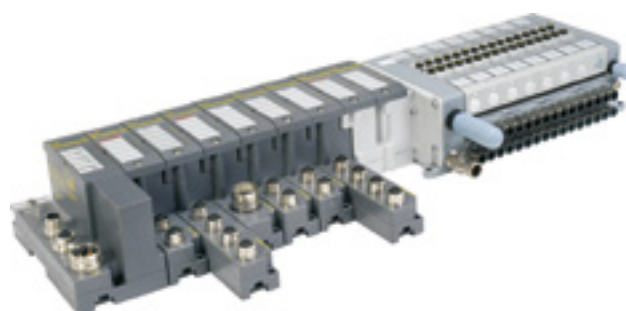

Island for Ethernet and IO-Link communication in decentralized application

In a decentralized application where an industrial communication is required and only a few valves are necessary, several communication protocol nodes are also available.

In that case, the valve island has to be equipped with a communication node adaptor.

With either a P2M Industrial Ethernet or IO-Link node, up to 24 solenoid valves can be piloted.



Island with multi-pole connection

In a decentralized application, when a multi-pole connection is required, the valve island head module can be equipped with a standard Sub-D25 connector.

With this Sub-D25 connection, up to 24 solenoid valves can be piloted.



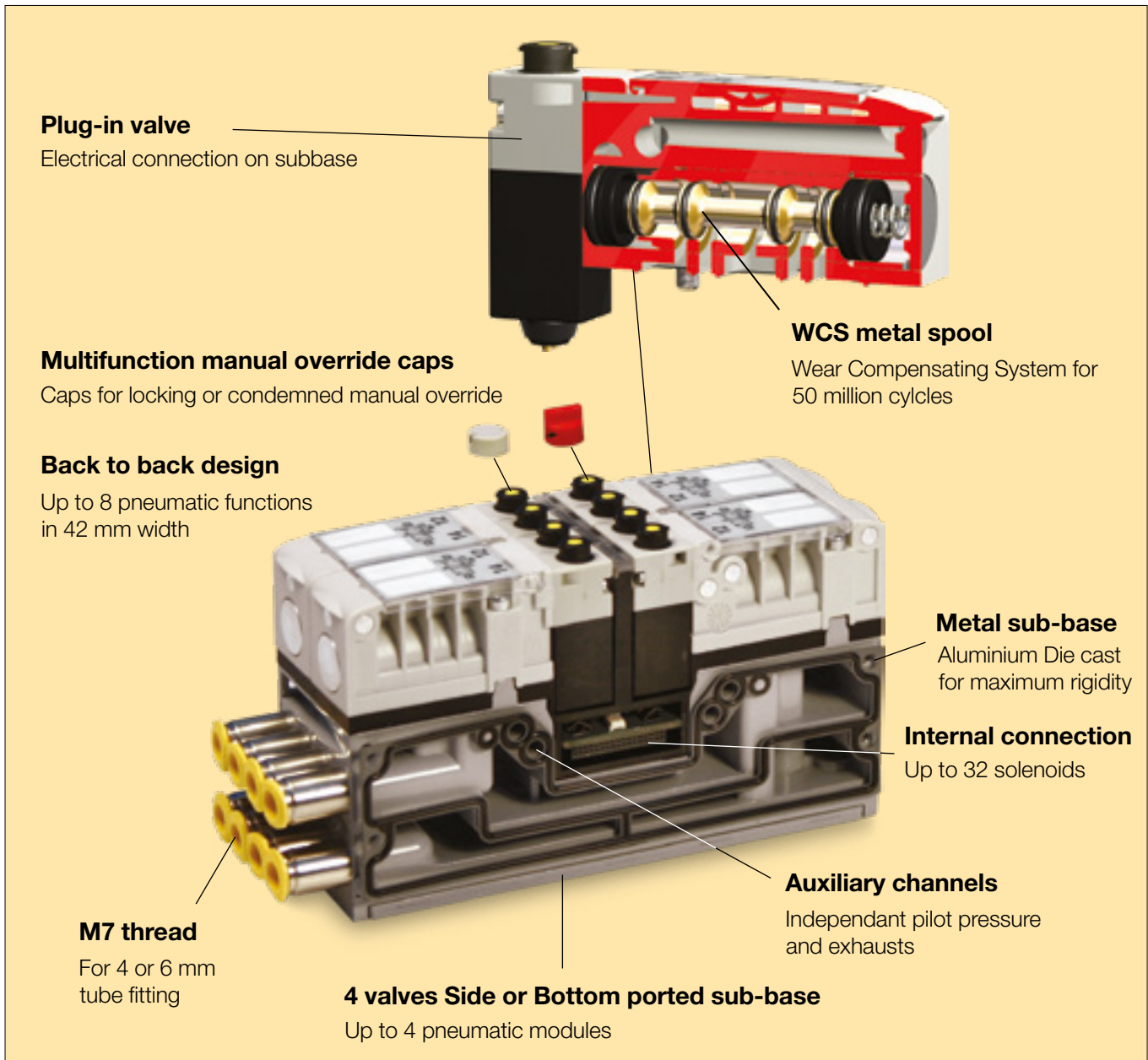

Material Specification

Valve spool :	Brass
Valve spool enclosure :	Brass
Dynamic seals :	Nitrile
Valve body :	Polyamide reinforced fibreglass
Seals :	Nitrile
Springs :	Stainless steel
Top cover :	Polyester
Subbase - End plates :	Painted aluminium

Certification

EMC / CE mark. :	According to EN 61 000-6-2
Dust & water protection :	IP65 according to EN 60529

Flow Characteristics

Dual 3/2

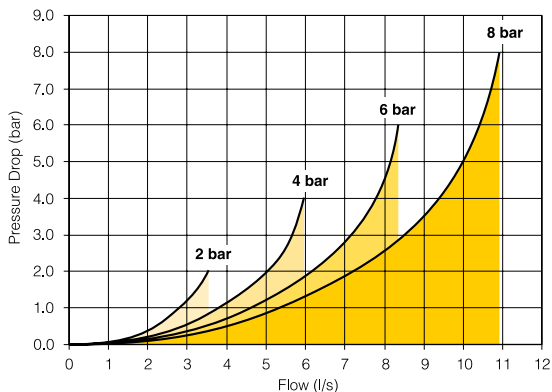

Operating pressure :	2,7 to 8,3 bar
Change-over time (side 14)	Actua. 15 ms Return 20 ms P = 6b
Change-over time (side 12)	15 ms / 25 ms P = 6b
Flow (acc. to ISO 6358) :	c = 1,2 NI/s x bar b = 0,13 Qn = 4,6 NI/s Qmax = 8,4 NI/s

5/2 single and double solenoid

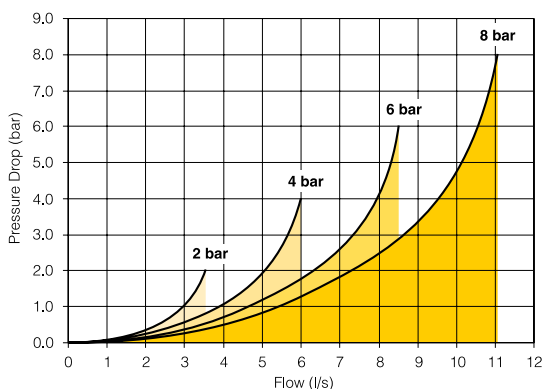

Operating pressure single solenoid:	2,7 to 8,3 bar
Operating pressure double solenoid:	1,7 to 8,3 bar
Change-over time single solenoid:	Actua. 15 ms Return 25 ms P = 6b
Change-over time double solenoid:	13 ms / 13 ms P = 6b
Flow (acc. to ISO 6358) :	c = 1,2 NI/s x bar b = 0,13 Qn = 4,7 NI/s Qmax = 8,5 NI/s

5/3 all ports blocked

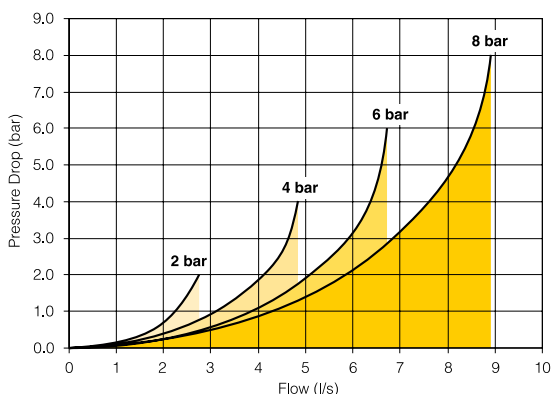

Operating pressure :	2,7 to 8,3 bar
Change-over time	Actua. 20 ms Return 20 ms P = 6b
Flow (acc. to ISO 6358) :	c = 1 NI/s x bar b = 0,14 Qn = 3,8 NI/s Qmax = 6,7 NI/s

Characteristics

Fluid :	Air or inert gas Filtered 40 μ Class 5 (according to ISO 8573-1) Dry class 4 (according to ISO 8573-1) Non-lubricated or lubricated	Operating pressure :	-0.9 to 8,3 bar with external pressure 6 bar
Storage temperature :	-40 °C to + 70 °C	Piloting pressure :	2.7 to 8.3 bar
Working temperature	-15 °C to + 50°C	Exhaust collection :	Independant exhaust collection
Vibration :	according to IEC 68-2-6 2G to 150 Hz	Rated coil voltage :	24 VDC -15 % / +10 %
Shock :	according to IEC 68-2-27 15G 11 ms	Electrical connection:	Not polarised
		Coil insulation :	Class B
		Power consumption :	1 W (42 mA) with LED
		Duty factor :	100 % at 20°C

Build your device configuration

Valve island components

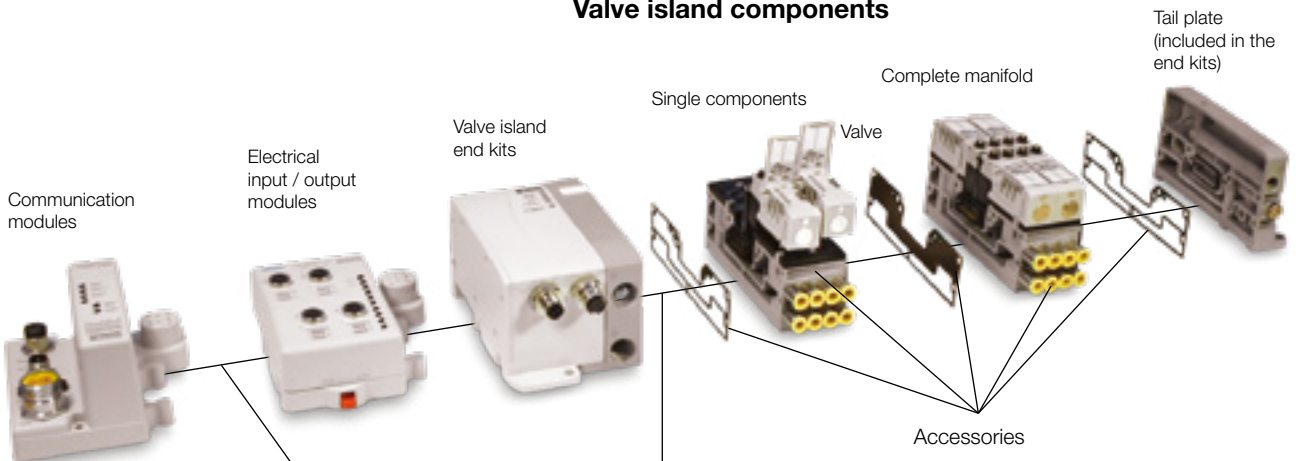

H Series Fieldbus System

Fieldbus and Industrial Ethernet

Up to 128 solenoid valves on 4 interconnected islands



Electro-mechanical interface to the TURCK - BL67 series

Up to 16 or 32 solenoid valves

Connected to the BL67 series from TURCK, offering :

- a wide choice of Fieldbus and industrial ethernet protocols
- a complete range of digital or analogic I/O modules with a large choice of connectivity

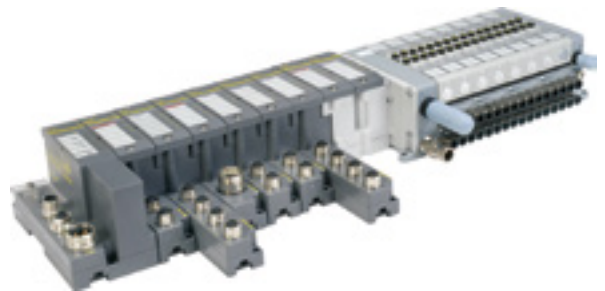

P2M communication node

Industrial Ethernet or IO-Link:
 Up to 24 solenoid valves



Multi-pole connection sub-D25

Up to 24 solenoid valves



Valve island components

Manifold components:

Pages 14 & 15



Valve



Sub-base



Complete manifold

Fittings and accessories:

Pages 16 & 17



Fittings



Multi-pressure manifold seals

H Series Fieldbus components

Valve island Ends kit, Fieldbus & Industrial Ethernet modules, I/O modules and accessories:

Pages 18 to 21



32 outputs drivers



Industrial communication modules



Bus extender



I/O modules



Accessories

Valve Driver Module to TURCK BL67 adaptor

Valve island Ends kit, 16 outputs & Blank modules:

Pages 22 to 27



16 or 32 Outputs drivers



Industrial communication gateway



Electronic and Power feeding modules



Base modules

P2M Communication node components

Valve island Ends kit, Industrial Ethernet & IO-Link Communication nodes and accessories:

Pages 28 & 29



Communication node



Communication node adaptor



Accessories

Multi-pole connection components

Sub-D25 Ends kit and cables:

Pages 30 & 31



Sub-D25 end kits



Cables

Valve ordering chart



HMEVX2049A

Pneumatic function		Manual override	
E	5/2 Single solenoid - Spring return	0	None, (no solenoid *)
2	5/2 Double solenoid	2	Non locking, Flush, Multi-functional
5	5/3 All ports blocked (APB)		
N	Double 3/2 NC		
P	Double 3/2 NO		
Q	Double 3/2 NC + NO		

Solenoid pilot	
49	24 VDC standard
XX	No solenoid pilot *

Blanking plate / Pressure module	
B	Blanking plate
C	Pressure module

* Only available with B & C

Manifold ordering chart (without valve module and fitting)

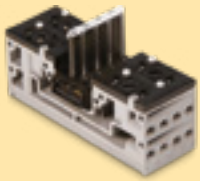

PSM21JAP

Manifold design	Thread type
1	Side ported M7
2	Bottom ported M7

Electronic circuit board	
J	Single address *
M	Double address

Single address sub-bases are only used with 5/2 single solenoid for saving the address

Manifold ordering chart (complete with valve modules and/or fittings)

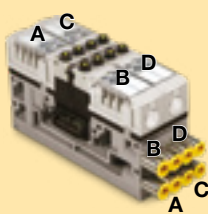

PSM31JAPN6N62456

Manifold design	Thread type
1	Side ported M7
2	Bottom ported M7











Electronic circuit board	
J	Single address
M	Double address

Pneumatic function	
X	Without valve module - fittings only
E	5/2 Single solenoid - Spring return
2*	5/2 Double solenoid
5*	5/3 All ports blocked (APB)
N*	Double 3/2 NC
P*	Double 3/2 NO
Q*	Double 3/2 NC + NO
C	Pressure module
B	Blanking plate



Straight fittings	
0	Without fitting
4	4 mm OD
6	6 mm OD
7	1/4" OD
P	Plug (for blanking plate)

* Double address electronic circuit board (type M) required











Solenoid operated valve fitted with 24 VDC solenoid

	Symbol	Description	Weight (g)	Order code
 <p>Including multi-function manual override cap</p>		Double 3/2 NC + NC	60	HMNVX2049A
		Double 3/2 NO + NO	60	HMPVX2049A
		Double 3/2 NC + NO	60	HMQVX2049A
		5/2 single solenoid - Spring return	49	HMEVX2049A
		5/2 double solenoid	60	HM2VX2049A
		5/3 all ports blocked (APB)	65	HM5VX2049A
		Blanking module kit (including two M7 plugs for manifold)	30	HMBVX00XXA
		Additional pressure module	30	HMCVX00XXA

Metal manifold for 4 valves (M7 threaded)

	Description	Weight (g)	Order code
 <p>Side ported</p>	4 position manifold single electrical address	332	PSM21JAP
	4 position manifold double electrical address	332	PSM21MAP
 <p>Bottom ported</p>	4 position manifold single electrical address	310	PSM22JAP
	4 position manifold double electrical address	310	PSM22MAP

Complete manifold without fitting (M7 threaded)

	Symbol	Description	Weight (g)	Order code
 <p>Side ported</p>		4 x Double 3/2 NC + NC	572	PSM31MAPN0N0N0N0
		4 x 5/2 single solenoid - Spring return	528	PSM31JAPE0E0E0E0
		4 x 5/2 double solenoid	572	PSM31MAP20202020
		4 x 5/3 all ports blocked (APB)	592	PSM31MAP50505050
 <p>Bottom ported</p>		4 x Double 3/2 NC + NC	550	PSM32MAPN0N0N0N0
		4 x 5/2 single solenoid - Spring return	506	PSM32JAPE0E0E0E0
		4 x 5/2 double solenoid	550	PSM32MAP20202020
		4 x 5/3 all ports blocked (APB)	570	PSM32MAP50505050

Multi-pressure Manifold with blocking plates

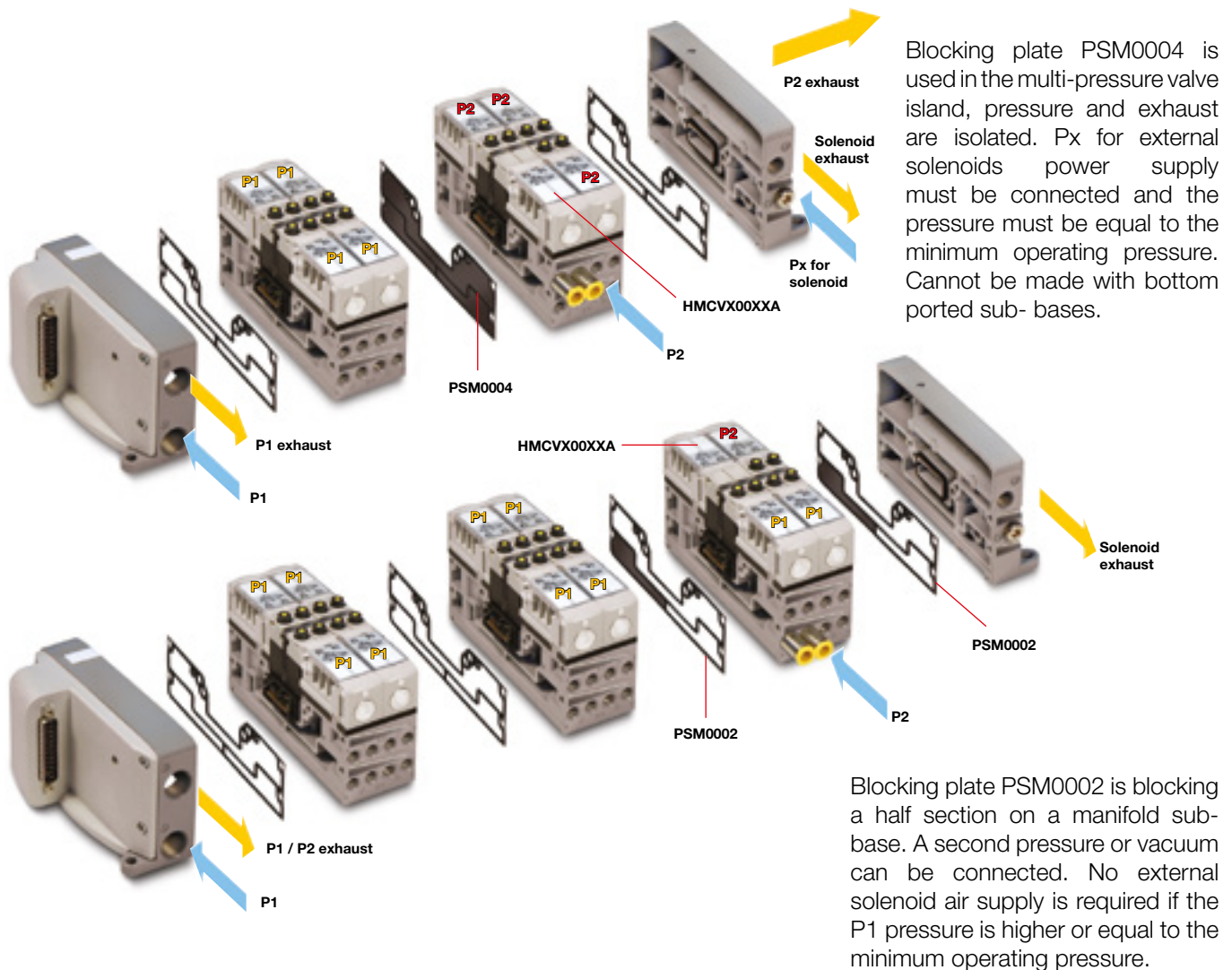



Auxiliary pressure for solenoid pilots and Exhaust channel

All end plates are delivered with an internal solenoid power supply version and can be easily changed to external solenoid power supply by simply moving a plug, if the main pressure is below the minimum operating pressure.

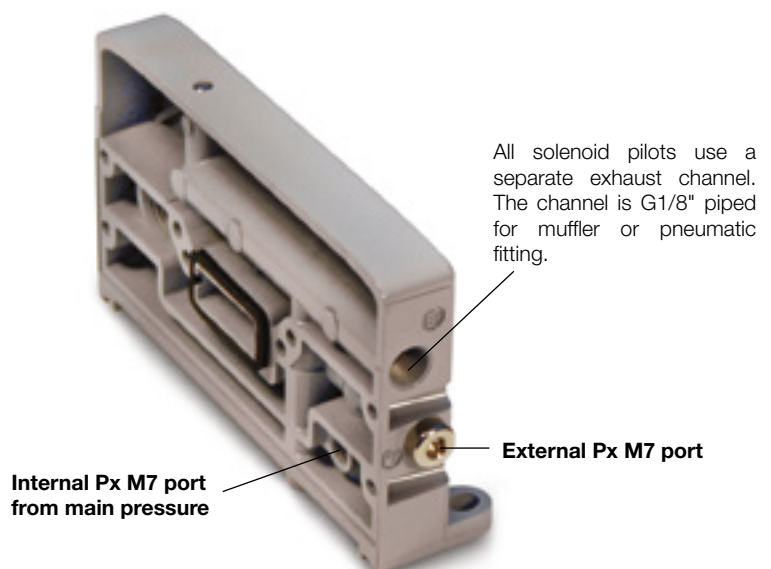
Auxiliary pressure supply port for solenoid pilot : This is a M7 port. The internal pilot supply end plate version includes an M7 plug. To change from internal supply to external supply mode, remove the plug and screw it into the internal Px port.



Pneumatic accessories

	Description	Size	Tube OD	Material	Order code
	Straight pneumatic connector for sub-base and Px	M7	4 mm	Metal	3181 04 55
		M7	6 mm	Metal	3181 06 55
	Straight pneumatic connector for Ex	1/8"	6 mm	Metal	3101 06 10
		3/8"	8 mm	Metal	3101 08 17
		3/8"	10 mm	Metal	3101 10 17
Straight pneumatic connector for Pressure and Exhaust ports	3/8"	12 mm	Metal	3101 12 17	
	Muffler for Ex	1/8"		Metal	ESB12MC
		1/8"		Plastic	P6M-PAB1
	Muffler for exhaust port	3/8"		Sintered metal	9090050900

Multi-pressure inter-manifold seal plate

	Description	Pressure port	Exhaust port	Weight (g)	Order code
	Inter-manifold seal plate	Passing / Passing	Passing	16	PSM0001
		Passing / Block	Passing	20	PSM0002
		Passing / Block	Block	30	PSM0003
		Block / Block	Block	40	PSM0004

Spare parts

	Description	Weight (g)	Order code
	24 VDC Pilot solenoid with screws	11	PSM0010
	Set of 10 multifunction manual override caps	15	PSM0011
	Set of 5 valve manifold gaskets and 10 screws	25	PSM0012
	Set of 10 M7 plugs for auxiliary pressure selection	30	PSM0013
	Set of 10 labels (in the P/N, x has to be replaced with the valve function letter, see page 14)	5	PSM002x
	Set of 10 manifold to manifold M3 screws	20	PSM0014

Multi-connection head module

P S M L 2 1 A P

Multi-wire connection	
L2	Sub-D25 connector

Ported design		Thread type
1	Side ported	3/8" BSPP
2	Bottom ported	3/8" BSPP
5	Side ported	3/8" NPT
6	Bottom ported	3/8" NPT

Sub-D25 connection

Up to 24 solenoids on standard Sub-D25 connector.



Technical data

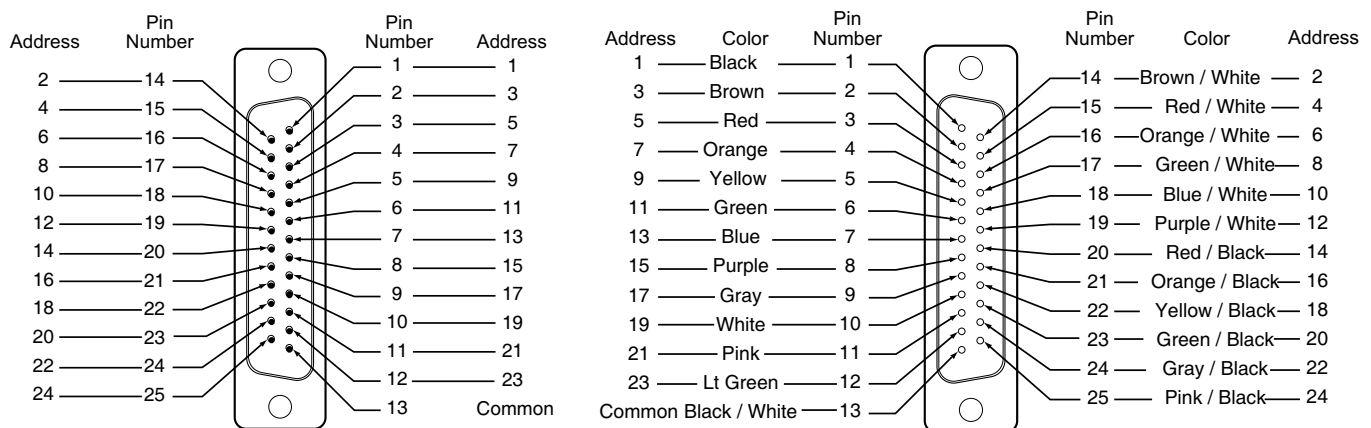

Rated voltage :	24 VDC
Maximum addresses :	24
Maximum energised simultaneously :	24
Electrical connection :	Sub-D25 pin DIN 41652, MIL-C-24308, NFC93425 type HE5
Polarity :	PNP and NPN compatible (solenoids not polarized)
Dust and water protection :	IP65 rated with properly assembled IP65 rated cable

Electrical multi-pole end modules

	Description	Sub-base design	Thread type	Weight (g)	Order code
	Sub-D25 ends module	Side ported	3/8" BSPP	250	PSML21AP
		Bottom ported	3/8" BSPP	250	PSML22AP

Electrical accessories

	Description	Cable length	Weight (g)	Order code
	Sub-D25 connector IP40 with flying leads multi-cable	3 m	380	P8LMH25M3A
		9 m	780	P8LMH25M9A
P8LMH25M3A	Sub-D25 connector IP65 with flying leads multi-cable	9 m	790	P8LMH25B9A

H Series Fieldbus 32 output driver end modules ordering chart



P S M L 6 1 A P

H Series Fieldbus 32 Output driver end modules		
	24 VDC power supply connector	Extender bus connector
L6	NO	NO
M5	NO	YES
M6	YES	NO
M7	YES	YES

	Ported design	Thread type
1	Side ported	3/8" BSPP
2	Bottom ported	3/8" BSPP
5	Side ported	3/8" NPT
6	Bottom ported	3/8" NPT

32 outputs driver selection guide :

L6 type

- H Series Fieldbus 32 outputs driver with internal solenoids power supply from the communication head module
- Extended valve island not possible



Up to 32 solenoid valves per island

M6 type

- H Series Fieldbus 32 outputs driver with external solenoids power supply by M12 male connector
- Extended valve island not possible



Up to 32 solenoid valves per island

M7 type

- H Series Fieldbus 32 outputs driver with external solenoids power supply by separated M12 male connector
- Extended Bus link connection for additional valve islands by separate M12 female connector



Up to 32 solenoid valves per island

M5 type

- H Series Fieldbus 32 outputs driver with internal solenoids power supply from the communication head module
- Extended Bus link connection for additional valve islands by separate M12 female connector



Up to 32 solenoid valves per island

H Series Fieldbus bus extender

H Series Fieldbus bus extender communication 1 meter cable for instant valve island plug-in by M12 male connector and direct head connection plate on H Series Filedbus device Every extended island has to be separately power supplied

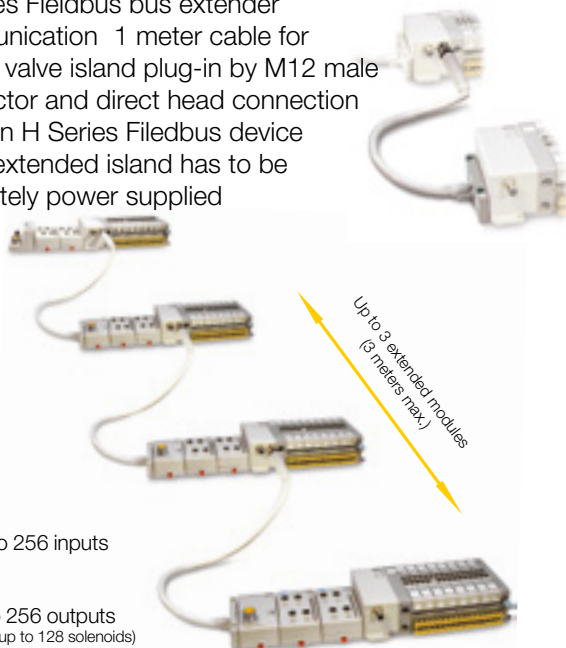

Technical data

H Series Fieldbus 32 Outputs driver modules

Number of Outputs : 32
 Operating Voltage Range : 20,4 to 26.4 VDC
 Output current rating Nom. : 50 mA per chanel (100 mA Max)
 3.2A per module
 Pointbus current : 200 mA
 Working temperature : -15°C to 50°C
 Dust and water protection : IP65

H Series Fieldbus 32 outputs driver modules

	Sub-base design	Thread type	24 VDC power supply	Extender bus	Weight (g)	Order code
	Side ported	3/8" BSPP	NO	NO	400	PSML61AP
	Bottom ported	3/8" BSPP	NO	NO	400	PSML62AP
	Side ported	3/8" BSPP	YES	NO	400	PSMM61AP
	Bottom ported	3/8" BSPP	YES	NO	400	PSMM62AP
	Side ported	3/8" BSPP	NO	YES	400	PSMM51AP
	Bottom ported	3/8" BSPP	NO	YES	400	PSMM52AP
	Side ported	3/8" BSPP	YES	YES	400	PSMM71AP
	Bottom ported	3/8" BSPP	YES	YES	400	PSMM72AP

H Series Fieldbus bus extender

	Description	Weight (g)	Order code
	Head plate 1 meter cable / M12 male connector for extended island inter-connection	380	PSSVEXT1

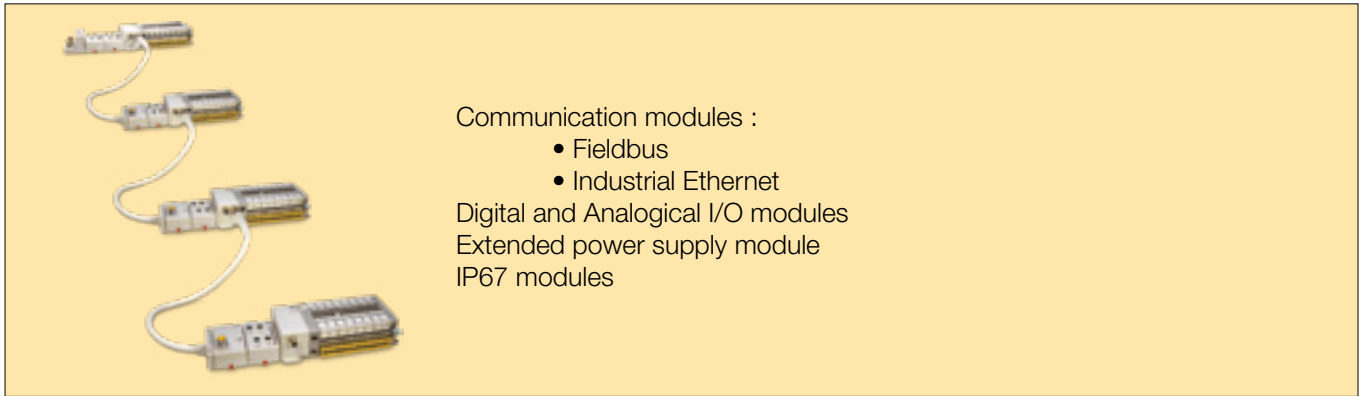

Communication modules :

- Fieldbus
- Industrial Ethernet

Digital and Analogical I/O modules
 Extended power supply module
 IP67 modules

H Series Fieldbus Communication and I/O modules

H Series Fieldbus Communication modules

H Series Fieldbus communication modules are available in :

- DeviceNet
- Profibus DP
- Ethernet I/P
- ControlNet



Digital or Analogical electrical I/O modules

Some modules have diagnostic features, electronic fusing, or individually isolated inputs/ outputs. The H Series Fieldbus family provides a wide range of input and output modules to span many applications, from highspeed discrete to process control. H Series Fieldbus supports producer/consumer technology, which allows input information and output status to be shared among multiple Logix controllers.



H Series Fieldbus Extension Power Unit

The auxiliary power supports up to 10 I/O modules and 32 output driver with a maximum of 10 A field power. The 24 VDC extension power unit (PSSSE24A) extends the backplane bus power to support up to 10 more I/O modules. Connect additional extension power units to expand the I/O assembly up to 63 I/O modules

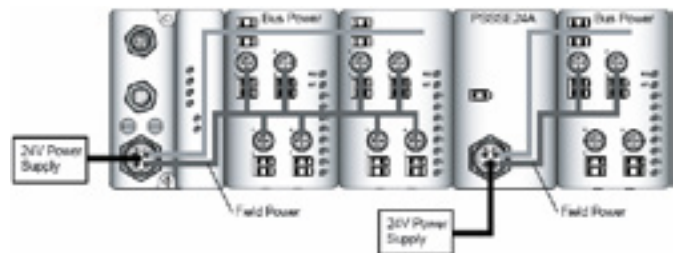

Technical data

H Series Fieldbus Communication modules & Extension power unit

Bus power supply : 24 VDC at 400 mA
 Power supply input voltage : 24 VDC
 Operative voltage range : 10 to 28.8 VDC
 Input overvoltage protection : Reverse polarity protected

H Series Fieldbus Analogue Input modules

Number of Outputs : 2
 Input signal Range : 4 to 20 mA / 0 to 10 VDC
 Pointbus current : 75 mA

H Series Fieldbus Analogue Output modules

Number of Outputs : 2
 Input signal Range : 4 to 20 mA / 0 to 10 VDC
 Pointbus current : 75 mA

H Series Fieldbus Digital Input modules

Number of Outputs : 8 – PNP or NPN
 Operating Voltage Range : 10 to 28.8 VDC
 Input current on-state : 2 to 5 mA
 Input current off-state : 1,5 mA
 Pointbus current : 75 mA

H Series Fieldbus Digital Output modules

Number of Outputs : 8
 Operating Voltage Range : 10 to 28.8 VDC
 Output current rating Max. : 1 A per channel
 3 A per module
 Pointbus current : 75 mA





H Series Fieldbus Relay Output modules

Number of Outputs : 4 – NO contacts
 Operating Voltage Range : 5 to 28.8 VDC
 Output current rating Max. : 2 A per channel
 8 A per module
 Pointbus current : 90 mA

H Series Fieldbus Communication Modules

	Description	Fieldbus connection	Power supply connector	Weight (g)	Order code
	DeviceNet	M18	7/8" - 4 pins	400	PSSCDM18PA
		M12 - A coding	7/8" - 4 pins	400	PSSCDM12A
	Profibus DP	M12 - B coding	7/8" - 5 pins	380	PSSCPBA
	Ethernet I/P	M12 - D coding	7/8" - 4 pins	380	PSSCENA
	ControlNet	M12 - D coding	7/8" - 4 pins	380	PSSCCNA



H Series Fieldbus Electrical I/O Modules

	Description	Polarity	Connector type	Weight (g)	Order code
	8 Digital Inputs	PNP	8 x M8	400	PSSN8M8A
			4 x M12	380	PSSN8M12A
		NPN	4 x M12	380	PSSP8M12A
	8 Digital Outputs	PNP	8 x M8	400	PSST8M8A
			4 x M12	380	PSST8M12A
			1 x M23	400	PSST8M23A
	4 Digital Outputs	Relay	4 x M12	410	PSSTR4M12A
	2 Analogue Inputs	0 - 10 V	2 x M12	400	PSSNAVM12A
		4 - 20 mA	2 x M12	400	PSSNACM12A
	2 Analogue Outputs	0 - 10 V	2x M12	400	PSSTAVM12A
		4 - 20 mA	2 x M12	400	PSSTACM12A



H Series Fieldbus Auxiliary Electrical Modules

	Description	Connector type	Weight (g)	Order code
	24 VDC expansion power unit	7/8" - 4 pins	420	PSSSE24A

H Series Fieldbus Bus Extender

	Description	Length	Weight (g)	Order code
	Bus extender cable for H Series Fieldbus module interconnection	1 meter	380	PSSEXT1
		3 meters	760	PSSEXT3
	H Series Fieldbus termination module		200	PSSTERM

H Series Fieldbus Accessories

	Description	Bus protocol	Connector type	Weight (g)	Order code
	Power supply connector	DeviceNet, ControlNet & Ethernet	7/8" - 4 pins	40	P8CS7804AA
		Profibus DP	7/8" - 5 pins	40	P8CS7805AA
	Line termination	DeviceNet	M12 - A coding	25	P8BPA00MA
		Profibus DP	M12 - B coding	25	P8BPA00MB
	Bus IN female connector	DeviceNet	M12 - A coding	25	P8CS1205AA
	Profibus DP	M12 - B coding	25	P8CS1205AB	
	Bus OUT male connector	DeviceNet	M12 - A coding	25	P8CS1205BA
	Profibus DP	M12 - B coding	25	P8CS1205BB	
	Cable quick connect connector		M8	25	P8CS0803J
	"Y" shape, thread to thread		M12 - A coding	25	P8CS1204J
			M12 - 2 x M12	25	P8CSY1212A

H Series Micro end plates with Turck BL67 Adaptor



TURCK
Industrial Automation

P S M T 2 1 A P

TURCK BL67 Series adaptor	
T0	Valve Driver Module without output module
T1	Valve Driver Module for 16 Outputs
T2	Valve Driver Module for 32 Outputs

For T0 version, 16 output module and blank module can be ordered separately from the next page or directly from TURCK under the same part number.

	Ported design	Thread type
1	Side ported	3/8" BSPP
2	Bottom ported	3/8" BSPP
5	Side ported	3/8" NPT
6	Bottom ported	3/8" NPT

Valve driver Module for 16 or 32 Outputs

Modularity up to 16 or 32 Outputs :

Thanks to its modularity, the H Series Micro Valve Driver Module to Turck BL67 Remote I/O System adaptor can be configure up to either a 16 or 32 solenoid valves configuration :

For a light configuration up to 16 solenoid valves (2 double address or 4 single address manifolds), the Valve Driver Module can be optimized being populated with:

- 1 Standard Turck 16 DO module BL67-16DO-0.1A-P in slot 1
- 1 blank module BL67-E in slot 2

For a full configuration up to 32 solenoid valves (4 double address or 8 single address manifolds), the Valve Driver Module must be fully populated with 1 Standard Turck 16 DO module BL67-16DO-0.1A-P in each slot.

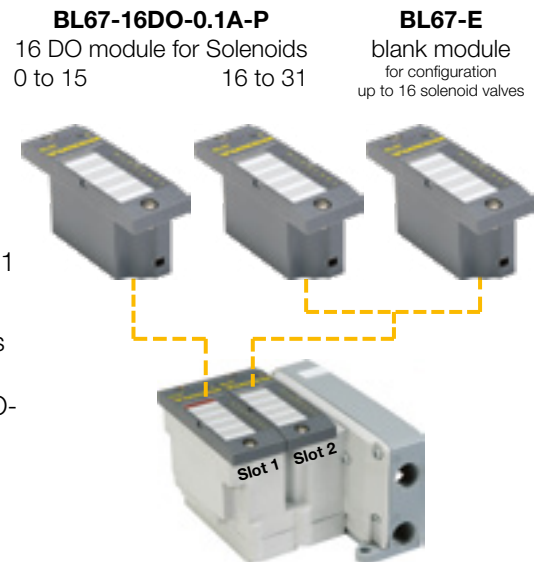

16 Outputs module BL67-16DO-0.1A-P technical specifications

Number of channels	16	Dimensions (W x L x H)	32 x 91 x 59 mm
Nominal voltage V_O	24 VDC	Approvals	CE, cULus
Rated current from field supply	≤ 100 mA	Operating temperature	Refer to solenoid valve
Rated current from module bus	≤ 30 mA	Storage temperature	-40°C to +70°C
Power loss, typical	≤ 1.5 W	Vibration	According to IEC68-2-6 : 2g to 150 Hz
		Shock test	According to IEC68-2-27 : 15g to 11 ms
Output type	PNP	Electro-magnetic compatibility	acc. to EN61131-2
Output voltage	24 VDC	Protection class	IP 65
Output current per channel	140 mA rated current (with VN 01-05 or higher)	Tightening torque fixing screws	0.9 ... 1.2 Nm
Output delay	3 ms		
Load type	resistive, inductive		
Short-circuit protection	yes		
Simultaneity factor	1		
Electrical isolation	electronics for the field level		



Full description of TURCK BL67 Series on <http://www.turck.com>

Valve Driver Module - TURCK BL67 adaptor

Description	Solenoid Valves	Sub-base design	Thread type	Weight (g)	Order code
	0	Side ported	3/8" BSPP	200	PSMT01AP
	Without 16 O module	Bottom ported	3/8" BSPP	200	PSMT02AP
		16 Outputs or blank module to be ordered separately (see below)			
	16 Including : - 1 x 16 O module - 1 blank module	Side ported	3/8" BSPP	270	PSMT11AP
		Bottom ported	3/8" BSPP	270	PSMT12AP
	32 Including : - 2 x 16 O modules	Side ported	3/8" BSPP	310	PSMT21AP
		Bottom ported	3/8" BSPP	310	PSMT22AP

Standard TURCK BL67 module

Description	Weight (g)	Order code
	16 Outputs module for 16 or 32 solenoid valves configuration	55 BL67-16DO-0.1A-P
	Blank module for 16 solenoid valves configuration	15 BL67-E

TURCK BL67 Remote I/O System

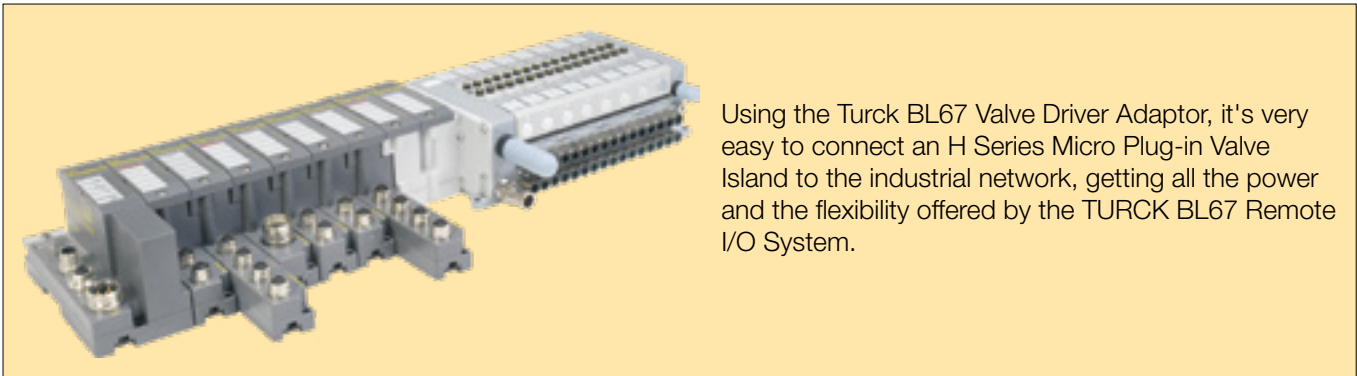

Using the Turck BL67 Valve Driver Adaptor, it's very easy to connect an H Series Micro Plug-in Valve Island to the industrial network, getting all the power and the flexibility offered by the TURCK BL67 Remote I/O System.

TURCK BL67 communication gateway

Industrial Communication :

- Linked to a TURCK BL67 communication module (programmable or not programmable), the device can be connected to a wide choice of Fieldbus or Industrial Ethernet protocols.

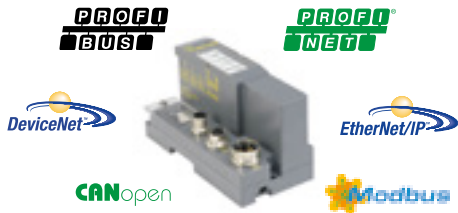

TURCK BL67 I/O and Base modules

The separation between electronic and base module for connectivity allows to complete the device with a choice through a full digital or analogue **I/O modules** range populating the **base module** existing with a multiple choice of electrical connection (M8, M12, M23)

The complete resulting configuration can handle :

- Up to 32 electrical modules (up to 2 in the Valve Driver Module)
- Up to 512 digital I/O (up to 32 outputs in the Valve Driver Module)
- Up to 128 analog I/O

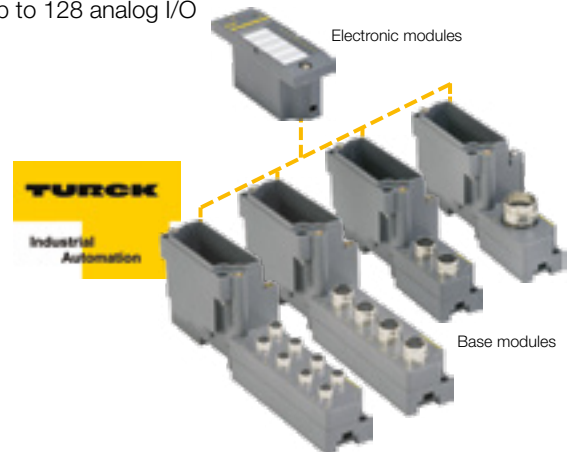

BL67 EtherNet/IP™ gateway to DeviceNet™

Using the TURCK BL67 EtherNet/IP™ gateway with DeviceNet™ master BL67-GW-EN-IP-DN, you can easily connect and configure a DeviceNet™ subnetwork thanks to the "SET-Button".

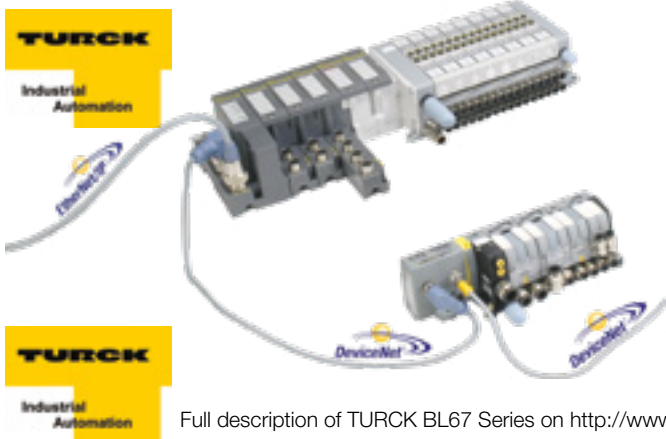

Full description of TURCK BL67 Series on <http://www.turck.com>

BL67 4 IO-Link Class A master

The 4 IO-Link master offers a very easy and cost efficient way to extend the capacity of a H Micro configuration



Other Turck BL67 Electronic modules

Other electronic modules, as CANopen gateway allowing a sub-network connectivity with other CANopen slaves, RFID System or counting modules complete the full TURCK BL67 Remote I/O System.



TURCK BL67 Communication Gateway

	Protocol	Network connection	Power Sup. Connection	Weight (g)	Order code
	CANopen (Bus IN & OUT)	M12 - A coding	7/8" - 5 Pin's	375	BL67-GW-CO
	DeviceNet™	7/8" - 5 Pin's	7/8" - 5 Pin's	360	BL67-GW-DN
	Profibus-DP (DPV0/DPV1)	M12 - B coding	7/8" - 5 Pin's	370	BL67-GW-DPV1
	Multiprotocol Ethernet: Modbus TCP, EtherNet/IP™ and PROFINET	M12 - D coding	7/8" - 5 Pin's	375	BL67-GW-EN
	Modbus TCP scan DeviceNet™	M12 - D coding	7/8" - 5 Pin's	375	BL67-GW-EN-DN
	Ethernet/IP™ scan DeviceNet™	M12 - D coding	7/8" - 5 Pin's	375	BL67-GW-EN-IP-DN

All TURCK BL67 System Modules can be ordered directly from TURCK under the same part number

TURCK BL67 Programmable



Communication Gateway

	Protocol	Network connection	Power Sup. Connection	Weight (g)	Order code
	CODESYS 2	Slave Profibus-DP	M12 - B coding	7/8" - 5 Pin's	BL67-PG-DP
		Slave EtherNet/IP™	M12 - D coding	7/8" - 5 Pin's	BL67-PG-EN-IP
		Slave Modbus TCP	M12 - D coding	7/8" - 5 Pin's	BL67-PG-EN
CODESYS 3	Multiprotocol Slave - Profinet - EtherNet/IP - Modbus TCP	M12 - D coding	7/8" - 5 Pin's	375	BL67-PG-EN-V3

All TURCK BL67 System Modules can be ordered directly from TURCK under the same part number

TURCK BL67 Electronic Modules

Decription	Characteristic	Polarity	Weight (g)	Order code	
4 Digital Inputs		PNP	55	BL67-4DI-P	
		NPN	55	BL67-4DI-N	
		Channel diagnostics	PNP	55	BL67-4DI-PD
8 Digital Inputs		PNP	55	BL67-8DI-P	
		NPN	55	BL67-8DI-N	
		Channel diagnostics	PNP	55	BL67-8DI-PD
16 Digital Inputs		PNP	55	BL67-16DI-P	
4 Digital Ouputs	0.5 A	PNP	55	BL67-4DO-0.5A-P	
		2.0 A	PNP	55	BL67-4DO-2A-P
		NPN	55	BL67-4DO-2A-N	
8 Digital Ouputs	4.0 A	PNP	55	BL67-4DO-4A-P	
		0.5 A	PNP	55	BL67-8DO-0.5A-P
			NPN	55	BL67-8DO-0.5A-N
16 Digital Ouputs	0.1 A	PNP	55	BL67-16DO-0.1A-P	
4 Digital Inputs & Ouputs	0.5 A - Channel Diagnostic	PNP	55	BL67-4DI4DO-PD	
8 Configurable Digital Channels	0.5 A	PNP	55	BL67-8XSG-P	
		PNP	55	BL67-8XSG-PD	
8 Isolated Relay Ouputs	Normally open		55	BL67-8DO-R-NO	
2 analogue Inputs	16 bit resolution	Current	55	BL67-2AI-I	
		Voltage	55	BL67-2AI-V	
		For Pt and Ni sensors	55	BL67-2AI-PT	
		For thermoelements	55	BL67-2AI-TC	
4 analogue Inputs	16 bit resolution	Current / Voltage	55	BL67-4AI-V/I	
		For thermoelements	55	BL67-4AI-TC	
2 analogue Outputs	16 bit resolution	Current	55	BL67-2AO-I	
		Voltage	55	BL67-2AO-V	
4 analogue Outputs	16 bit resolution	Voltage	55	BL67-4AO-V	

All TURCK BL67 System Modules can be ordered directly from TURCK under the same part number

The complete TURCK BL67 Remote I/O System range on <http://www.turck.com> and <http://www.parker.com/pneu/fieldbus>

TURCK BL67 Base modules for Digital and Analog I/O Modules



Description	Connector Type	Con. Number	Weight (g)	Order code
Base Modules	M8, 3-pole, female	4	160	BL67-B-4M8
		8	215	BL67-B-8M8
	M8, 4-pole, female	8	215	BL67-B-8M8-4
	M12, 5-pole, female, A-coded	2	185	BL67-B-2M12
	M12, 5-pole, female, A-coded, paired	2	185	BL67-B-2M12-P
	M12, 5-pole, female, A-coded	4	245	BL67-B-4M12
	M12, 5-pole, female, A-coded, paired	4	245	BL67-B-4M12-P
	M23, 12-pole, female	1	190	BL67-B-1M23
	M23, 19-pole, female	1	190	BL67-B-1M23-19

All TURCK BL67 System Modules can be ordered directly from TURCK under the same part number

Electronic and Base Module Combinations

	BL67-B-4M8	BL67-B-8M8	BL67-B-2M12	BL67-B-2M12-P	BL67-B-4M12	BL67-B-4M12-P	BL67-B-1M23	BL67-B-1M23-19	BL67-B-8M8-4
Digital Input Modules									
BL67-4DI-P	3		3	3	3		3		
BL67-4DI-N	3		3	3	3		3		
BL67-4DI-PD	3		3	3	3				
BL67-8DI-P		3			3	3	3		
BL67-8DI-N		3			3	3	3		
BL67-8DI-PD		3			3	3			
BL67-16DI-P								3	3
Digital Output Modules									
BL67-4DO-0.5A-P	3		3	3	3		3		
BL67-4DO-2A-P	3		3	3	3		3		
BL67-4DO-2A-N	3		3	3	3		3		
BL67-4DO-4A-P	3		3	3	3		3		
BL67-8DO-0.5A-P		3			3	3	3		
BL67-8DO-0.5A-N		3			3	3	3		
BL67-16DO-0.1A-P								3	3
BL67-4DI4DO-PD		3			3	3			
Configurable Digital Input/Output Modules									
BL67-8XSG-P		3			3	3			
BL67-8XSG-PD		3			3	3			
Relay Output Module									
BL67-8DO-R-NO						3			
Analogue Input Module									
BL67-2AI-I			3						
BL67-2AI-V			3						
BL67-2AI-PT			3						
BL67-2AI-TC			3						
BL67-4AI-V/I					3				
BL67-4AI-TC					3				
Analogue Output Module									
BL67-2AO-I			3						
BL67-2AO-V			3						
BL67-4AO-V					3				

The complete TURCK BL67 Remote I/O System range on <http://www.turck.com>

TURCK BL67 Power Feeding and Base Modules

Description	Connector Type	Weight (g)	Order code
			
	Power Feeding Module for 24 VDC additional sourcing		55 BL67-PF-24VDC
Base Modules	1 x 7/8", 5-pole, male	VI / VO Sourcing	55 BL67-B-1RSM
		VO Sourcing	55 BL67-B-1RSM-VO
	1 x 7/8", 4-pole, male	55 BL67-B-1RSM-4	

All TURCK BL67 System Modules can be ordered directly from TURCK under the same part number

Power Feeding Base Modules Connection

Standard version

BL67-B-1RSM

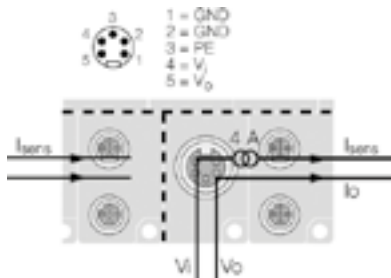

Other possible versions

BL67-B-1RSM-VO

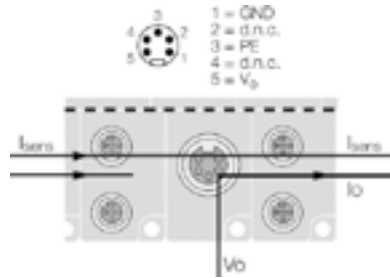

BL67-B-1RSM-4

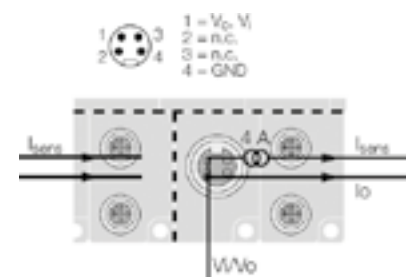

TURCK BL67 4 IO-Link Master and Base Module

Description	Connector Type	Weight (g)	Order code
			
	4 IO-Link Class A Master	55	BL67-4IOL
Base Modules	4 x M12, 4-pole, female, A-coded	170	BL67-B-4M12

All TURCK BL67 System Modules can be ordered directly from TURCK under the same part number

BL67-4IOL electronic module with BL67-B-4M12

- => Up to 32 pilot valves in the main configuration
- => Up to 88 (3 x 24 + 16) remote pilot valves per BL67 IO-Link master
- => Up to 15 BL67 IO-Link Class A masters

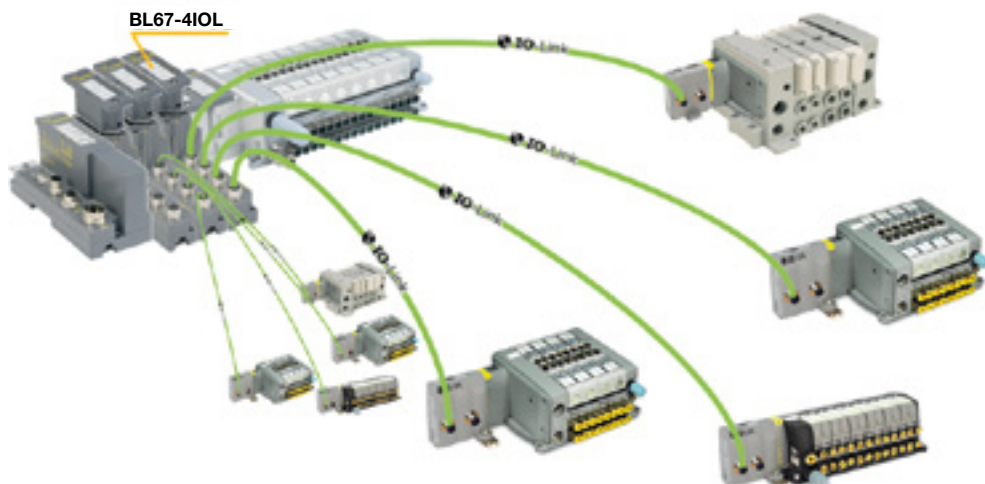

The complete TURCK BL67 Remote I/O System range on <http://www.turck.com>

24 Outputs P2M IO-Link Communication node adaptor

Valve adaptor ends kit

M4	Adaptor without communication node
ML	Adaptor with IO-Link 24 DO node

For adaptor with IO-Link module only (digit 4-5 = ML)	
Blank	Without IO-Link node (with option M4)
A13	IO-Link Class A node - Aux wiring 1 - 3 (standard)
A42	IO-Link Class A node - Aux wiring 4 - 2 (Turck, Rockwell)
A43	IO-Link Class A node - Aux wiring 4 - 3 (Siemens)
B25	IO-Link Class B node - Aux wiring 2 - 5 (standard)

	Ported design	Thread type
1	Side ported	3/8" BSPP
2	Bottom ported	3/8" BSPP
5	Side ported	3/8" NPT
6	Bottom ported	3/8" NPT

Safe Power Capability	
Blank	Not capable
-SPC	Safe Power Capable

P2M IO-link 24 DO Class A node with independent Auxiliary Power Supply



The P2M **IO-Link** Class A node can handle a Moduflex Valve bank having up to 19 pilot solenoid valves.

Thanks to its 2 x M12 A coded male connectors, it can be connected to any IO-Link Class A masters and separately receive its auxiliary power supply for valves from an independent source.

The P2M **IO-Link** Class A node exists in 3 versions with the Auxiliary Power M12 connector pin out adapted to any sourcing through a standard M12 cable:

- P2M2HBVL12400A13 version: 24 Vdc / 0 Vdc on pins 1 & 3 – Standard version
- P2M2HBVL12400A43 version: 24 Vdc / 0 Vdc on pins 4 & 3 – Compatible with Siemens wiring
- P2M2HBVL12400A42 version: 24 Vdc / 0 Vdc on pins 4 & 2 – Compatible with Rockwell wiring

P2M IO-link 24 DO Class B node



The P2M **IO-Link** Class B node can handle a Moduflex Valve bank having up to 19 pilot solenoid valves.

Thanks to its single M12 A coded male connectors, it can be connected to any IO-Link Class B masters receiving its auxiliary power supply for valves on pins 2 & 5 from the only cable simplifying the connection.

Diagnostic



The P2M **IO-Link** module offers a local diagnostic through 4 LED's located on the visible top side, showing:

- IO-Link com status
- Node error
- Output error
- Auxiliary power

Additional useful diagnostic information can be read by the PLC through the network simplifying diagnostic and allowing predictive maintenance (all details in the user manual)

Safe Power Capable version (-SPC)



Auxiliary power of -SPC version of P2M IO-Link 24 DO node can be supplied from a safe output device following machinery directives. This includes:

- Output Signa Switch Device (OSSD) test pulse compatible
- Galvanic isolation between 0 Vdc Logic and Aux power
- PP or PM cabling modes

For more details refer to the "Communication nodes - connection and configuration" section.

3/8" Ends kit with P2M IO-Link node



With P2M Communication node for 24 outputs (H Micro Pilot Valves)

	Description	IO-Link Class	M12 A coded Connector connection				Weight [g]	Order Code
			IO-Link	Aux. Power	Aux. Power Pinout			
 P2M Class A node	3/8" BSPP Front ported ends kit with P2M IO-Link Communication node	Class A	3 Pin's	3 Pin's	1 & 3	250	PSMML1APA13	
			3 Pin's	3 Pin's	4 & 3	250	PSMML1APA43	
		Class B	3 Pin's	5 Pin's	4 & 2	250	PSMML1APA42	
			5 Pin's	-	2 & 5	240	PSMML1APB25	
 P2M Class B node	3/8" BSPP Bottom ported ends kit with P2M IO-Link Communication node	Class A	3 Pin's	3 Pin's	1 & 3	250	PSMML2APA13	
			3 Pin's	3 Pin's	4 & 3	250	PSMML2APA43	
		Class B	3 Pin's	5 Pin's	4 & 2	250	PSMML2APA42	
			5 Pin's	-	2 & 5	240	PSMML2ABP25	

IODD file can be downloaded from IODD finder or the Moduflex web page:
<https://ioddfinder.io-link.com>
www.parker.com/pde/io-link

3/8" Ends kit with P2M IO-Link node - SPC Version

With P2M Communication node for 24 outputs (H Micro Pilot Valves)

	Description	IO-Link Class	M12 A coded Connector connection				Weight [g]	Order Code
			IO-Link	Aux. Power	Aux. Power Pinout			
 P2M Class A node	3/8" BSPP Front ported ends kit with P2M IO-Link Communication node Safe Power Capable	Class A	3 Pin's	3 Pin's	1 & 3	250	PSMML1APA13-SPC	
			3 Pin's	3 Pin's	4 & 3	250	PSMML1APA43-SPC	
		Class B	3 Pin's	5 Pin's	4 & 2	250	PSMML1APA42-SPC	
			5 Pin's	-	2 & 5	240	PSMML1APB25-SPC	
 P2M Class B node	3/8" BSPP Bottom ported ends kit with P2M IO-Link Communication node Safe Power Capable	Class A	3 Pin's	3 Pin's	1 & 3	250	PSMML2APA13-SPC	
			3 Pin's	3 Pin's	4 & 3	250	PSMML2APA43-SPC	
		Class B	3 Pin's	5 Pin's	4 & 2	250	PSMML2APA42-SPC	
			5 Pin's	-	2 & 5	240	PSMML2ABP25-SPC	

IODD file can be downloaded from IODD finder or the Moduflex web page:
<https://ioddfinder.io-link.com>
www.parker.com/pde/io-link

3/8" Ends kit for P2M IO-Link node



Without P2M Communication node

	Description	IO-Link Node	Sub-base design	Weight [g]	Order Code
	3/8" BSPP end kits adaptor	All versions	Front ported	200	PSMM41AP
			Bottom ported	200	PSMM42AP

Accessories

	Description	Connector type	Weight [g]	Order Code
 P8CS1205AA	Quick connect straight connector for both IO-Link communication and auxiliary power supply	M12 - 5 Pin's Female - A Coding	25	P8CS1205AA

24 Outputs P2M Industrial Ethernet Communication node

Valve adaptor ends kit	
M4	Adaptor without communication node
MN	Adaptor with PROFINET 24 DO node
ME	Adaptor with ETHERNET IP 24 DO node
MT	Adaptor with ETHERCAT 24 DO node
MW	Adaptor with POWERLINK 24 DO node
MM	Adaptor with MODBUS/TCP 24 DO node
MK	Adaptor with CC-LINK IE 24 DO node

	Ported design	Thread type
1	Side ported	3/8" BSPP
2	Bottom ported	3/8" BSPP
5	Side ported	3/8" NPT
6	Bottom ported	3/8" NPT

Product Set-Up



The P2M Industrial Ethernet 24 DO node offers an IP addressing through 3 rotary switches located on the top side.

The 3 rotary switches allow also a Factory Reset, IP address storage, and DHCP mode addressing.

As soon as supported by protocol, this IP address can be modified through an imbedded web page.

For an application requiring a regular disconnection / reconnection of the node, Profinet and EtherNet/IP protocols allow respectively a Fast Start-Up (FSU) and Quick Connect mode. This mode can be enable or disable .

Technology / Integrated Ethernet Switch



The P2M Industrial Ethernet 24 DO node offers 2 Ethernet ports allowing a line topology without external switch. The Ring topology can also be supported (enable/disable) for Profinet, EtherNet/IP and Modbus TCP/IP.

The integrated Ethernet switch support Class C Services allowing used in an isochronous real time (IRT) structure.

Diagnostic



The P2M Industrial Ethernet 24 DO node offers a local diagnostic through 7 LED's located on the visible top side, showing:

- Logic status
- Ethernet activity on both ports
- Standard Status due to protocol
- Output error / Auxiliary power

This local information as well as trouble shooting and predictive maintenance diagnostics (Power monitoring, Life cycle counting, ...) are available in PLC through the network and reported on imbedded web page.

When PLC is in "STOP", the web page allows to force ON/OFF solenoids state. This function has a password protection.

Safe Power Capable

Auxiliary power of P2M Industrial Ethernet 24 DO node can be supplied from a safe output device following machinery directives. This includes:

- Output Signal Switch Device (OSSD) test pulse compatible
- Galvanic isolation between 0 Vdc Logic and Aux power
- PP or PM cabling modes

For more details, refer to the "Communication nodes – connection and configuration" section.

3/8" Ends kit with P2M Industrial Ethernet node

With P2M Communication node for 24 outputs (H Micro Pilot Valves)



Description	Protocol	M12 A coded Connector connection			Order Code
		Eth. ports	Aux. Power	Weight [g]	
3/8" BSPP Front ported ends kit with P2M Industrial Ethernet Communication node	Profinet IO	2 x M12 D-coded	M12 A-coded	250	PSMMN1AP
	EtherNet /IP	2 x M12 D-coded	M12 A-coded	250	PSMME1AP
	EtherCAT	2 x M12 D-coded	M12 A-coded	250	PSMMT1AP
	Powerlink	2 x M12 D-coded	M12 A-coded	250	PSMMW1AP
	Modbus/TCP	2 x M12 D-coded	M12 A-coded	250	PSMMM1AP
	CC-Link IE	2 x M12 X-coded	M12 A-coded	250	PSMMK1AP
3/8" BSPP Bottom ported ends kit with P2M Industrial Ethernet Communication node	Profinet IO	2 x M12 D-coded	M12 A-coded	250	PSMMN2AP
	EtherNet /IP	2 x M12 D-coded	M12 A-coded	250	PSMME2AP
	EtherCAT	2 x M12 D-coded	M12 A-coded	250	PSMMT2AP
	Powerlink	2 x M12 D-coded	M12 A-coded	250	PSMMW2AP
	Modbus/TCP	2 x M12 D-coded	M12 A-coded	250	PSMMM2AP
	CC-Link IE	2 x M12 X-coded	M12 A-coded	250	PSMMK2AP

Configuration file can be download from the P2M Industrial Ethernet node web page:
www.parker.com/pde/p2m_ie

3/8" Ends kit for P2M Industrial Ethernet node

Without P2M Communication node



Description	Ethernet Protocol	Sub-base design	Weight [g]	Order Code
3/8" BSPP end kits adaptor	All protocols	Front ported	200	PSMM41AP
		Bottom ported	200	PSMM42AP

Accessories



Description	Connector type	Weight (g)	Order code
Quick connect straight connector for module power supply	M12 - 5 Pin's Female - A Coding	25	P8CS1205AA

IO-Link node connection and diagnostic functions



IO-Link node connection

Standard male M12 – type A

Usage of standard manufactured cables available from your usual electrical supplier is recommended.

Note: Auxiliary power for solenoids can be wired allowing the user to turn outputs off while the communications remains on.

Configuration

IODD file can be downloaded from IODD Finder or the Moduflex web site:

<https://ioddfinder.io-link.com>
www.parker.com/pde/io-link

Class B



Class A



Legend

Symbol	Description
L+	IO-Link Power Supply "+"
L-	IO-Link Power Supply "-"
C/Q	IO-Link communication
Aux +	Auxiliary Power Supply 24 Vdc
Aux -	Auxiliary Power Supply 0 Vdc

M12 Pin's	Class A		
	3 Pin's		5 Pin's
	P2M...A13	P2M...A43	P2M...A42
1	Aux +	Not used	Not used
2	-	-	Aux -
3	Aux -	Aux -	Not used
4	n.c.	Aux +	Aux +
5	-	-	Not used

Case of use with SAFE power source for valve control

The Moduflex IO-Link node can be powered from a 24Vdc auxiliary source in PP or PM mode as grounds are isolated.

For compatibility with a safe output pulsed module, please refer to user manual document No 30048690201W05 available on www.parker.com/pde/io-link.

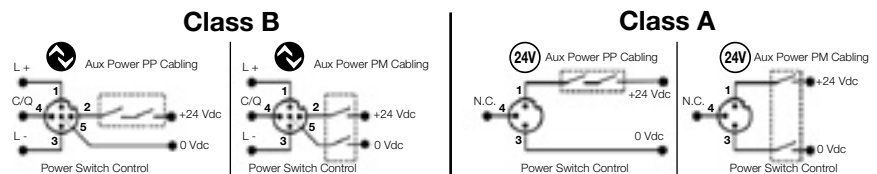

Cabling for P2M2HBVL12400A13

IO-Link node diagnostic functions

The Moduflex IO-Link node offers additional useful module status information:

- Pilot overload or short circuit
- Auxiliary Voltage out of tolerance
- Cycle counter for every pilot
- Module temperature

For deeper information on product technical information and module diagnostic functionalities, please refer to the User Manual available from the product web page:

www.parker.com/pde/io-link

COM Green LED			Module—Error Red LED			Error—Output Red LED			POWER Green LED		
LED Status	Description	Solving	LED Status	Description	Solving	LED Status	Description	Solving	LED Status	Description	Solving
OFF	IO-Link L+ / L- not powered	Check connection	OFF	Standard mode	NA	OFF	Standard mode	NA	OFF	AUX power failure	Check Auxiliary Power Supply
ON	IOL L+ / L- powered IO mode	Set IO-Link mode in IO-Link master	ON	24 Vdc AUX power missing or any active malfunction	Check power supply or change module	ON	Any driver error (overload, over temperature, etc.)	Fix solenoid issue then acknowledge error	ON	Standard	NA
Blinking	IO-Link communication active	NA							Blinking	Aux Power is out of range, alarm level	Check Auxiliary Power Supply

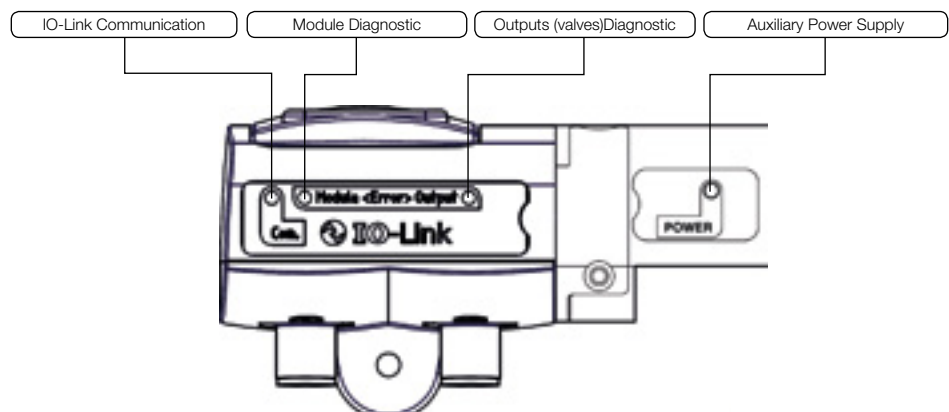

Industrial Ethernet node connection and diagnostic functions

Ethernet Ports and Auxiliary Power Connection

Ethernet ports: 2 x Standard Female M12 D-Coded – 5 pins
 Auxiliary Power: Standard Male M12 A-Coded – 4 pins.

Usage of standard manufactured cables available from your usual electrical supplier is recommended.

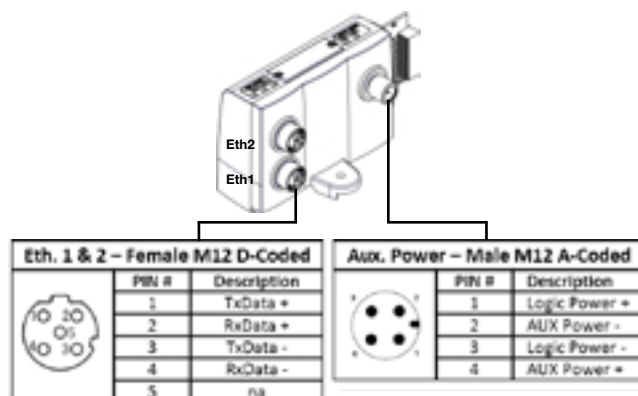

Configuration File

The configuration files can be download from the product web page: www.parker.com/pde/P2M_IE.

IP Address Setting

The IP-Address of the device can be assigned via:

- Rotary Switches, DHCP, Web page, Ipconfig Tool or TCP/IP Interface Object, depending on protocol version:

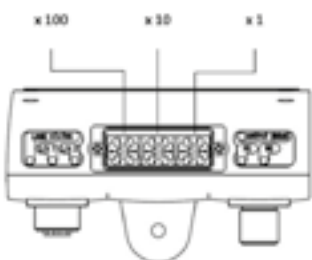

Description	EtherNet/IP Profinet IO Modbus TCP/IP	Ethernet PowerLink	EtherCAT	CC-Link IE
IP-Address setting stored into the NV-memory of the P2M node	000	000	N/A	000
IP-Address setting determined by the 3 rotary switches:				
• IP Address: 192.168.1.xxx				
• Subnet Mask: 255.255.255.0	001 - 254	001 - 239	N/A	001 - 120
• Default Gateway for 001: 192.168.1.2				
• Default Gateway for 002 - 254: 192.168.1.1				
The device will obtains its address via DHCP	888	N/A	N/A	N/A
Reset to factory status	999	999	999	999
Invalid. The module will not start (see Local Visual Diagnostic section for details)	All others	All others	All others	All others

Case of Use with SAFE Power Source for Valve Control

The P2M Industrial Ethernet 24 DO nodes can support a SAFE OSSD power source for valve control (Aux + / Aux -). It can also be connected in both PP or PM mode.

For further details, please refer to the Ethernet node user manual available from the product web page:

- www.parker.com/pde/P2M_IE

Local and network diagnostic functions

Local diagnostic

The P2M Industrial Ethernet node offers a local diagnostic via 7 LED's. Pls refer to user manual with interpretation given by this table.

Network diagnostic

The P2M Industrial Ethernet node offers additional useful module status information:

- Pilot overload or short circuit
- Auxiliary Voltage out of tolerance
- Cycle counter for every pilot
- Module temperature
- ...

For deeper information on product technical information and a complete interpretation of node diagnostic functionalities, please refer to the User Manual available from the product web page:

www.parker.com/pde/P2M_IE

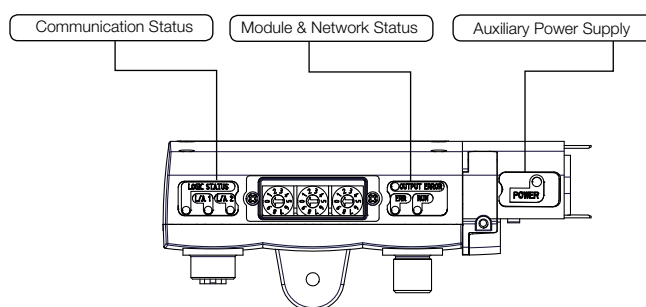

Centralized bus - Side ported

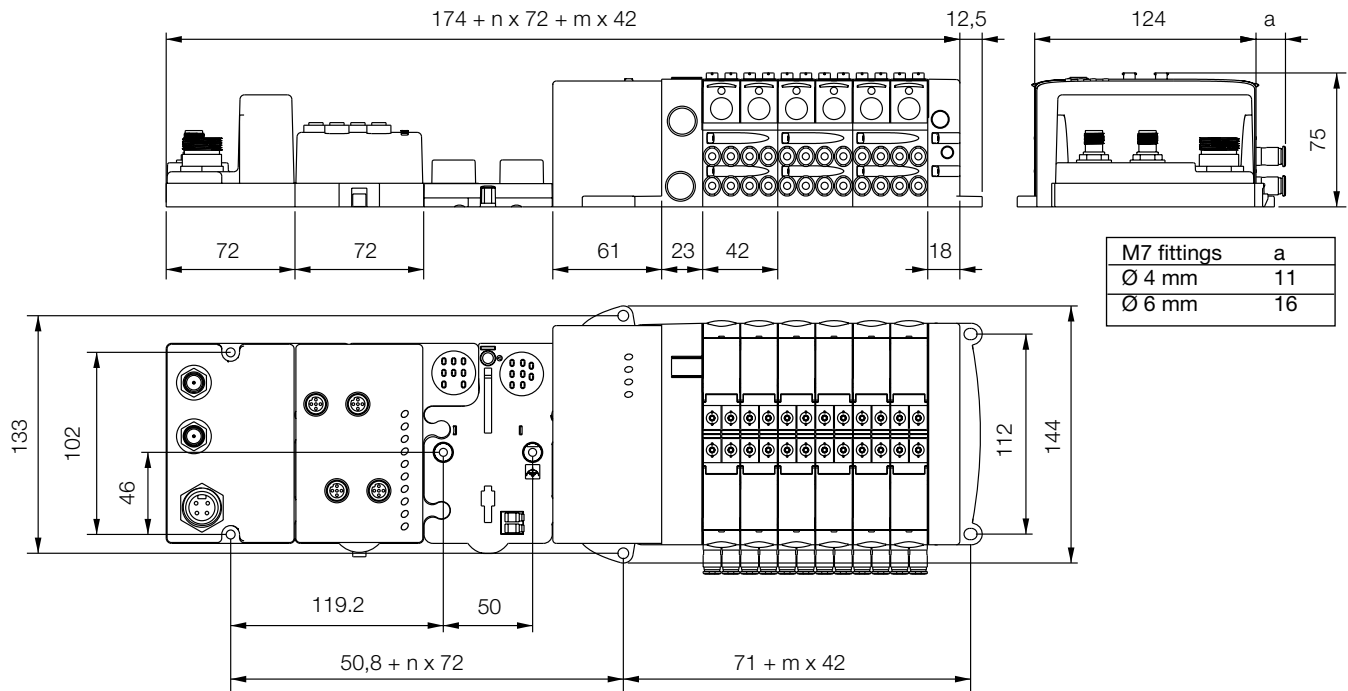

Centralized bus - Bottom ported

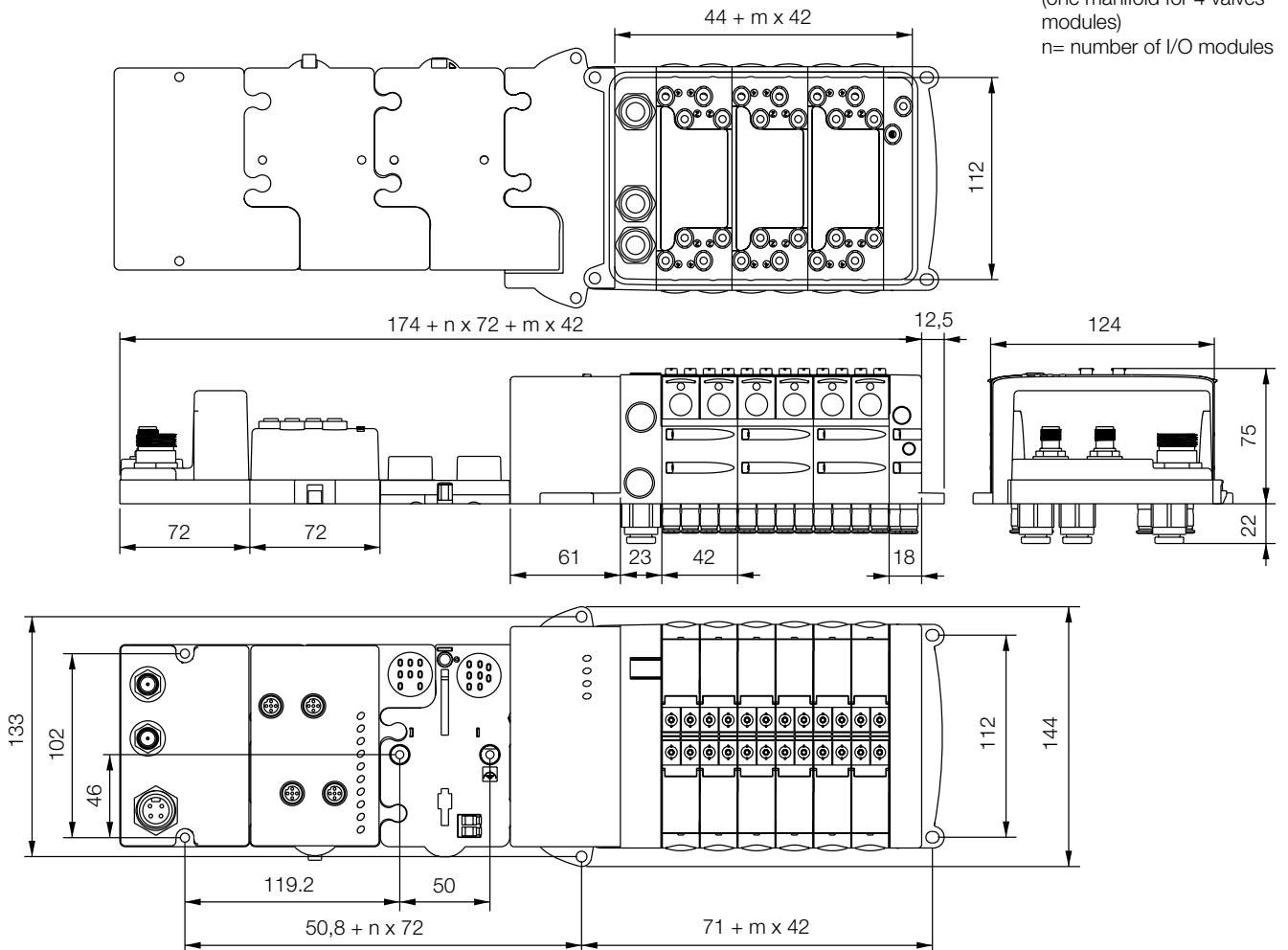

H Series Micro with TURCK BL67 Remote I/O System

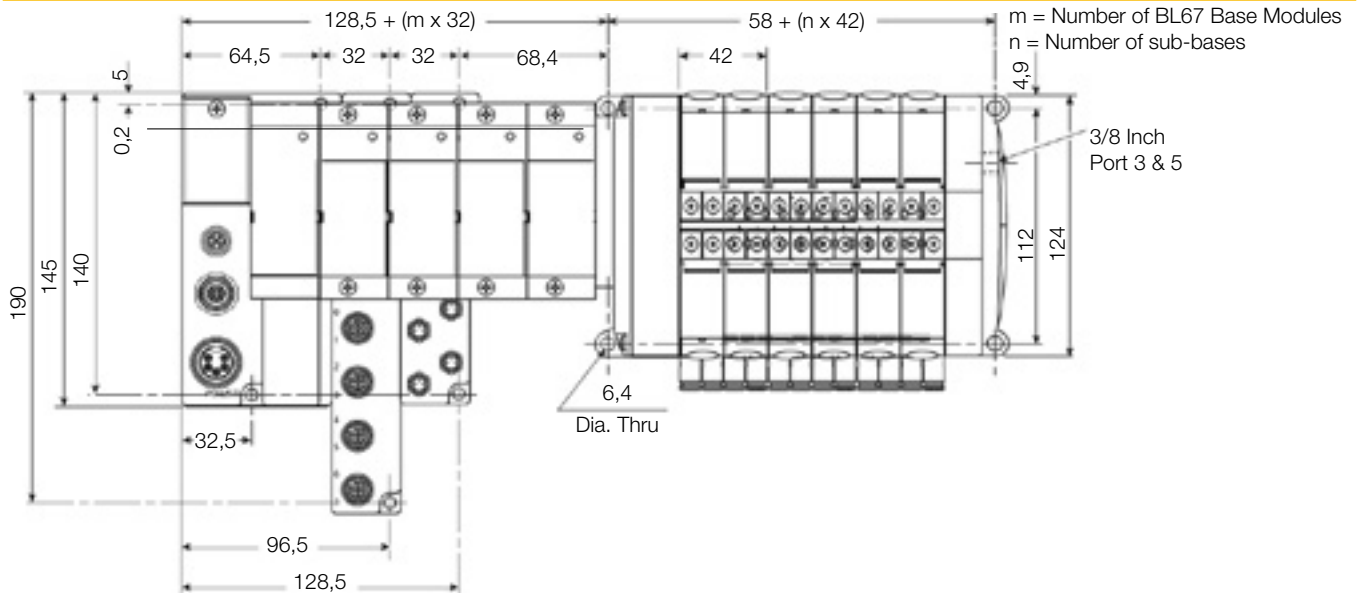

H Series Micro with TURCK BL67 adaptor - Side ported

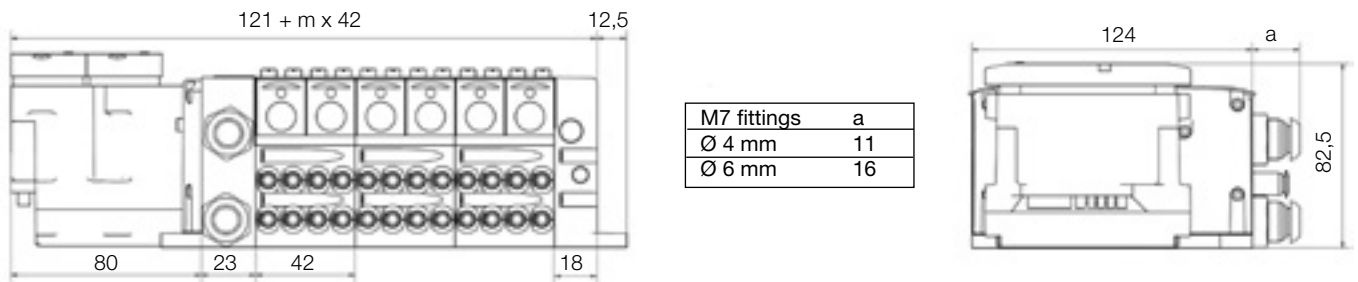

H Series Micro with TURCK BL67 adaptor - Bottom ported

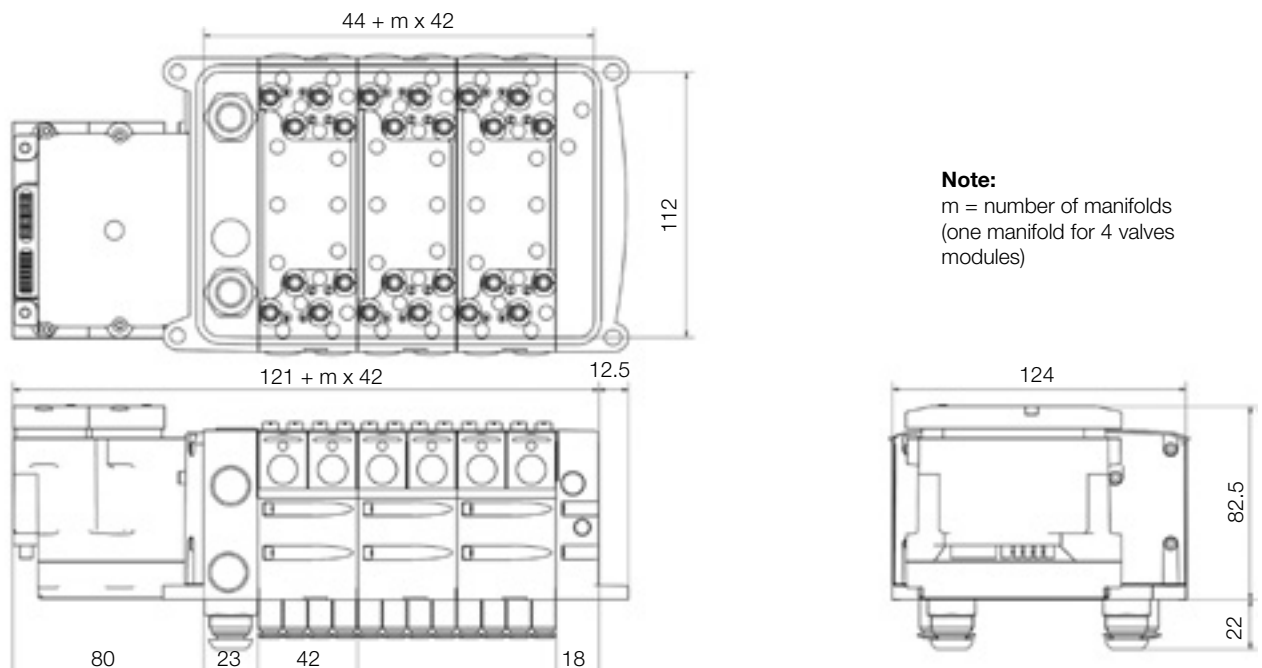

P2M Communication node - Side ported

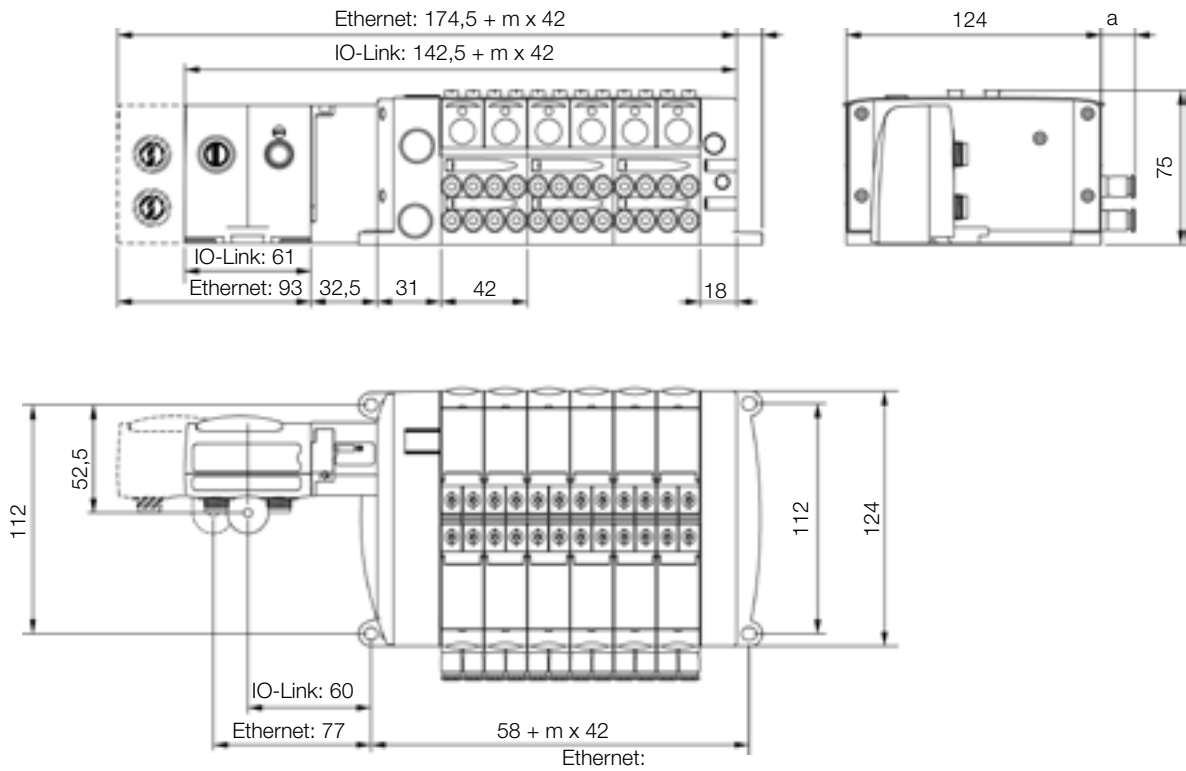

P2M Communication node - Bottom ported

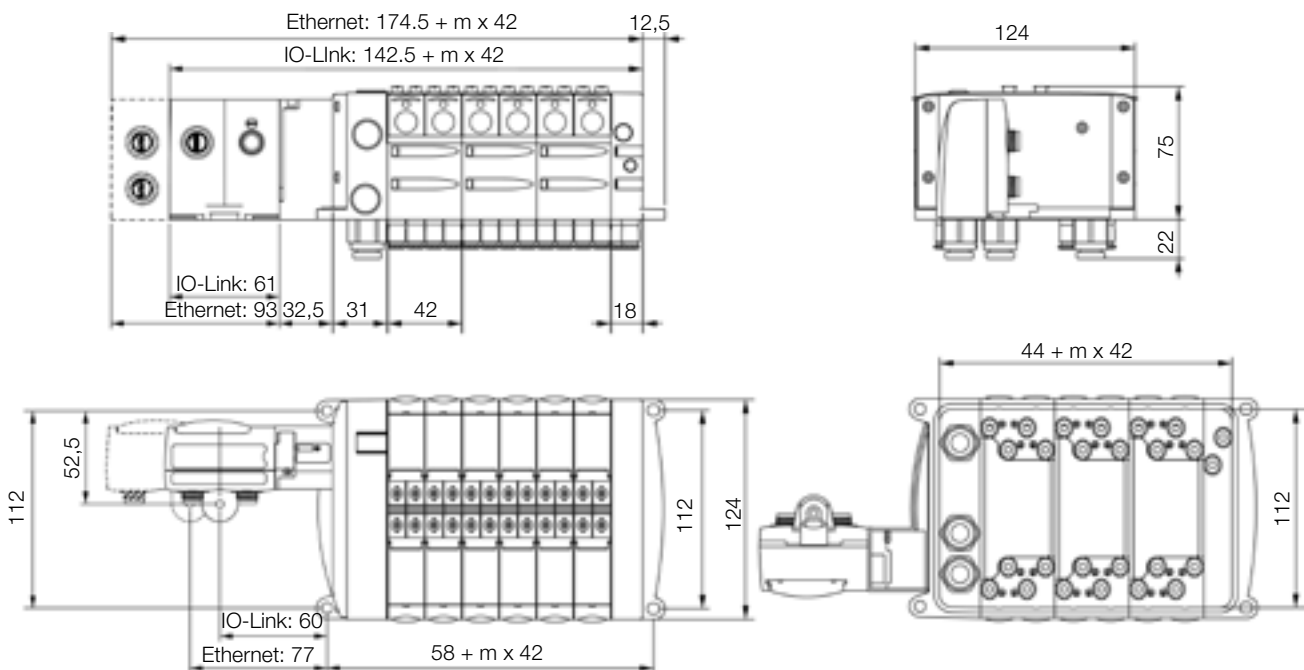

SubD25 - Side ported

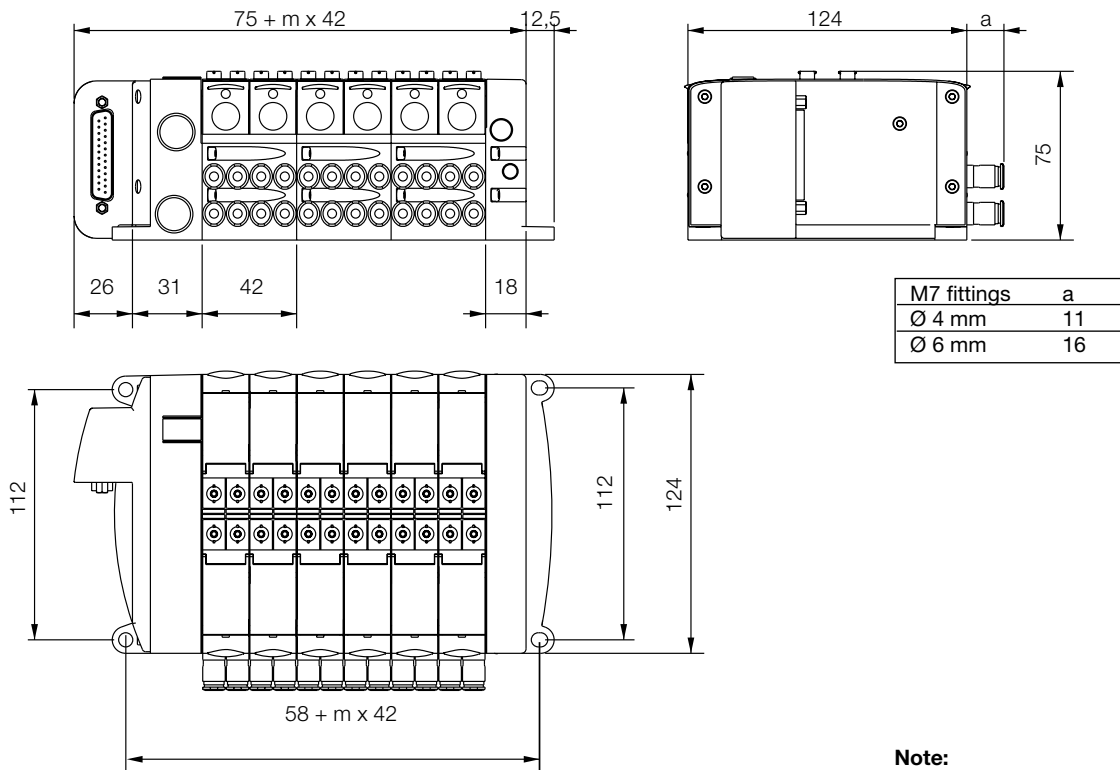

Note:
 m = number of manifolds
 (one manifold for 4 valves
 modules)

SubD25 - Bottom ported

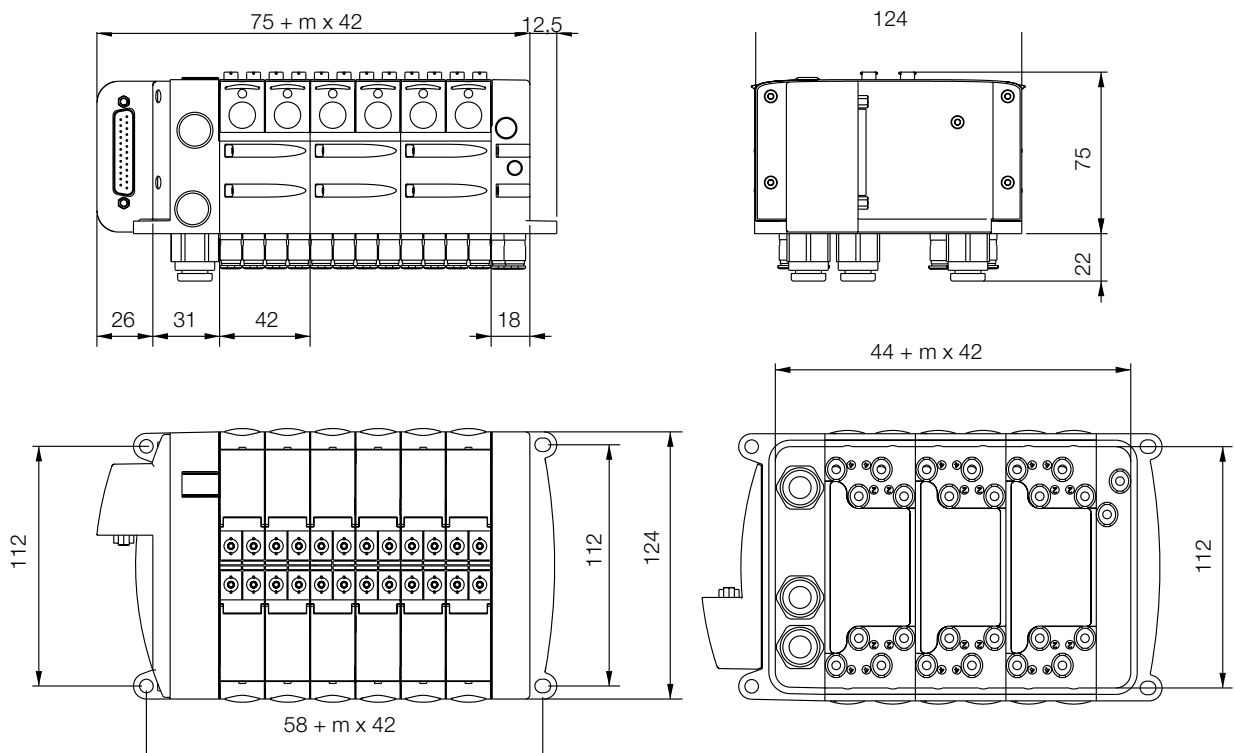

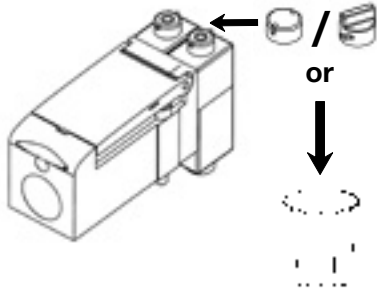

0,4 mN mini.
 0,6 mN maxi.

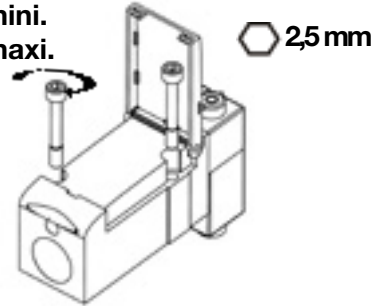

A

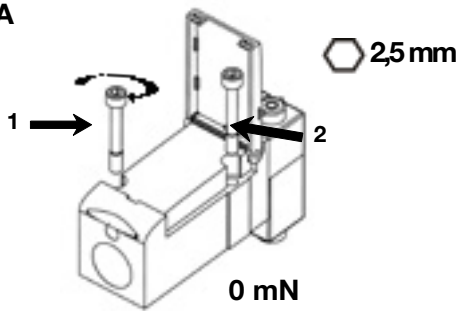

W930019620111

B

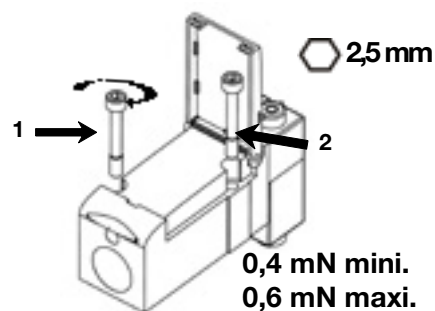

<http://www.parker.com/Pneumatic>

300196201W05 02



**H Series Micro
 Installation & Service Instructions
 Sheet B**

**ISSUED: 06 2008
 Supersedes: None**

WARNING: Failure to follow all precautions, warnings, instructions, and information contained herein, and from the Parker website, may cause death, personal injury, and/or property damage. More detailed information, in several languages, may be obtained from the Parker website:

www.parker.com or call 1-800-C PARKER in the USA or 00 800 27 27 53 74 in Europe.

W930019620111

<http://www.parker.com/Pneumatic>

300196201W05 02

GENERAL SAFETY GUIDELINES

- Always disconnect the electric and air supply to the valve before adjusting.
- Always lockout power to machinery that the valve is attached to before adjusting.
- Keep hands and clothing away from any pinch points & paths of moving cylinders.
- Never disassemble valves without proper instruction and manuals. This may be obtained from a distributor or the website described above.

GENERAL INSTALLATION GUIDELINES

- Push plug-in pneumatic connectors securely into the modules and assemble the valve islands as shown on reverse side.
- Secure the valve or valve island using the din-rail fasteners or the mounting holes.
- Attach Parker tubing to the pneumatic connectors. Completely push clean, square-cut precision tubing into the pneumatic connectors.
- Attach electrical connections with power off.
- Test the system operation for function and leakage. Do not put into operation until the function is as intended and there is no leakage.



PSM . . AP

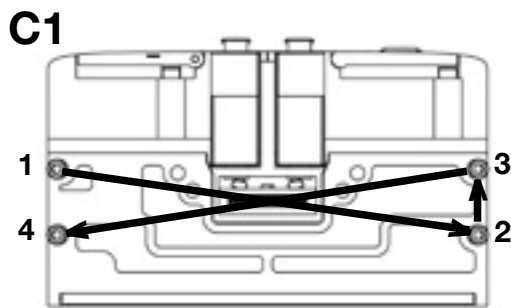
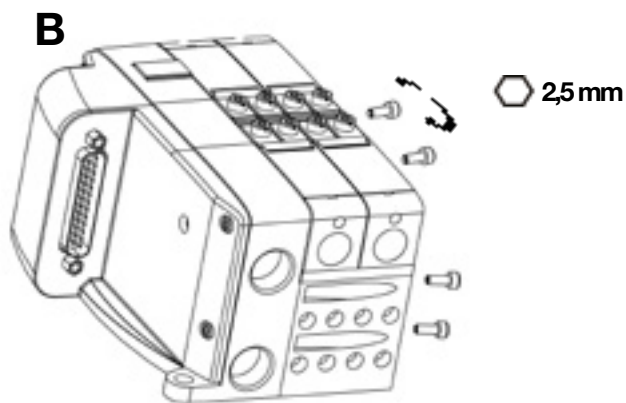
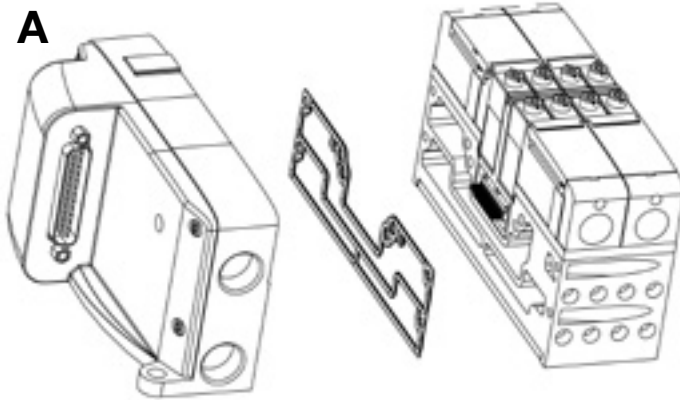

1, 2, 3, → 4 ↻ 0 mN

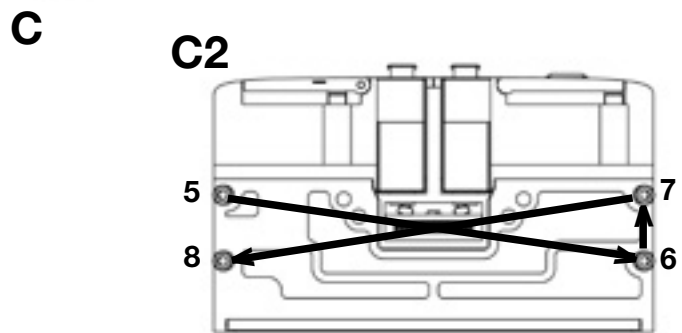

5, 6, 7, → 8 ↻ 0,5 mN mini.
0,8 mN maxi.

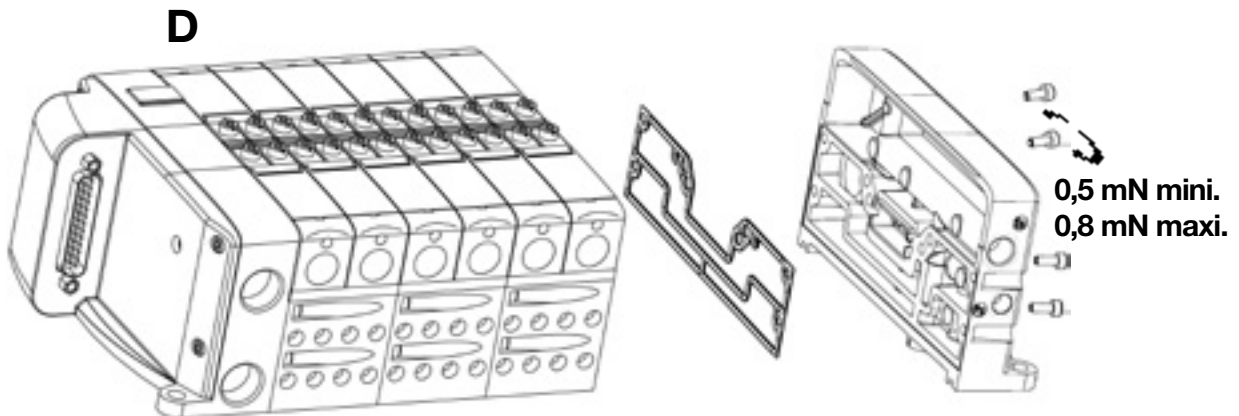



Inter-manifold seal plate

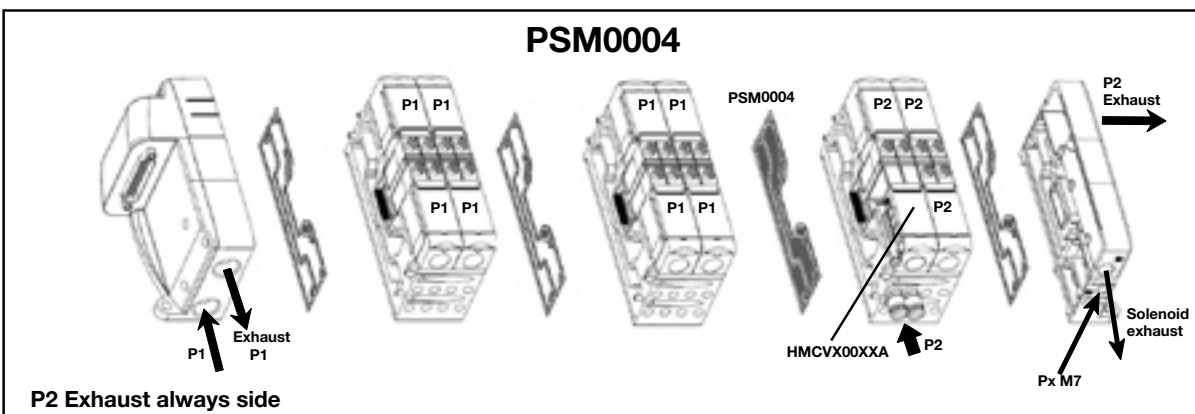
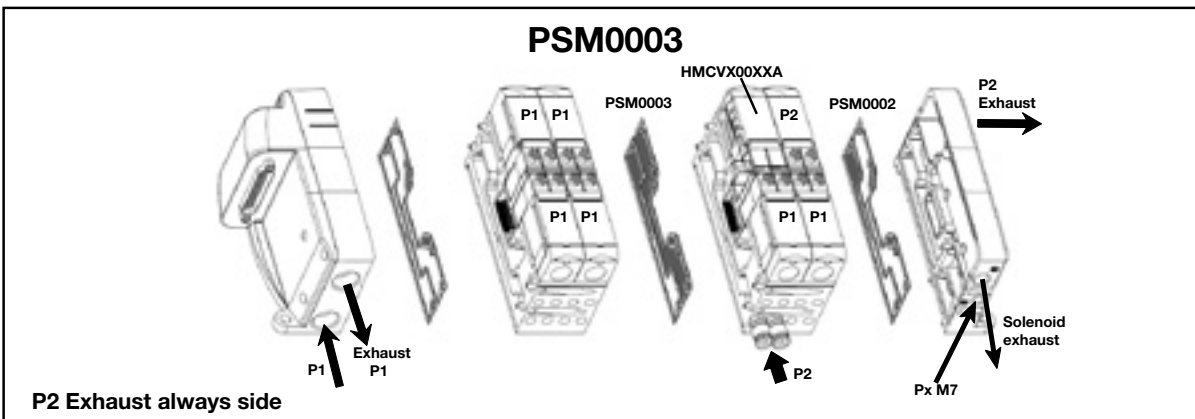
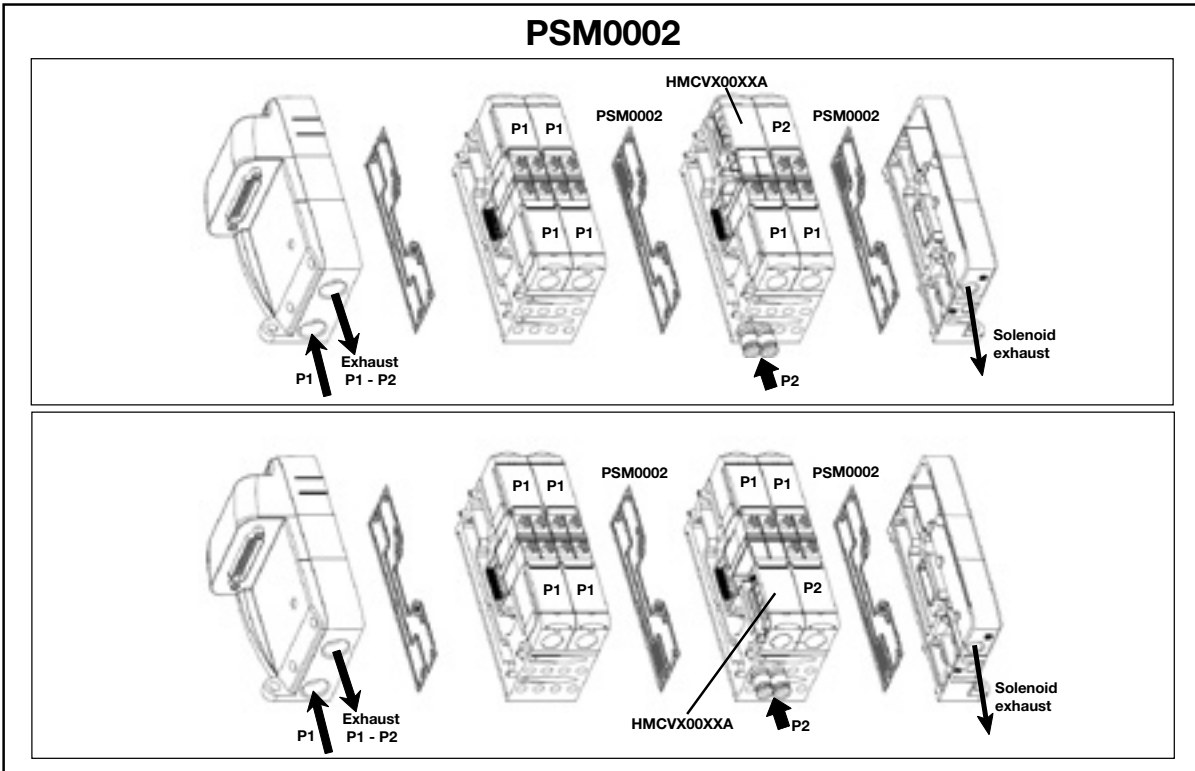

Operating pressure -0.9 to 8.3 bar, with external pilot pressure 6 bar. Solenoid pressure supply 2.7 to 8.3 bar





PSM...AP

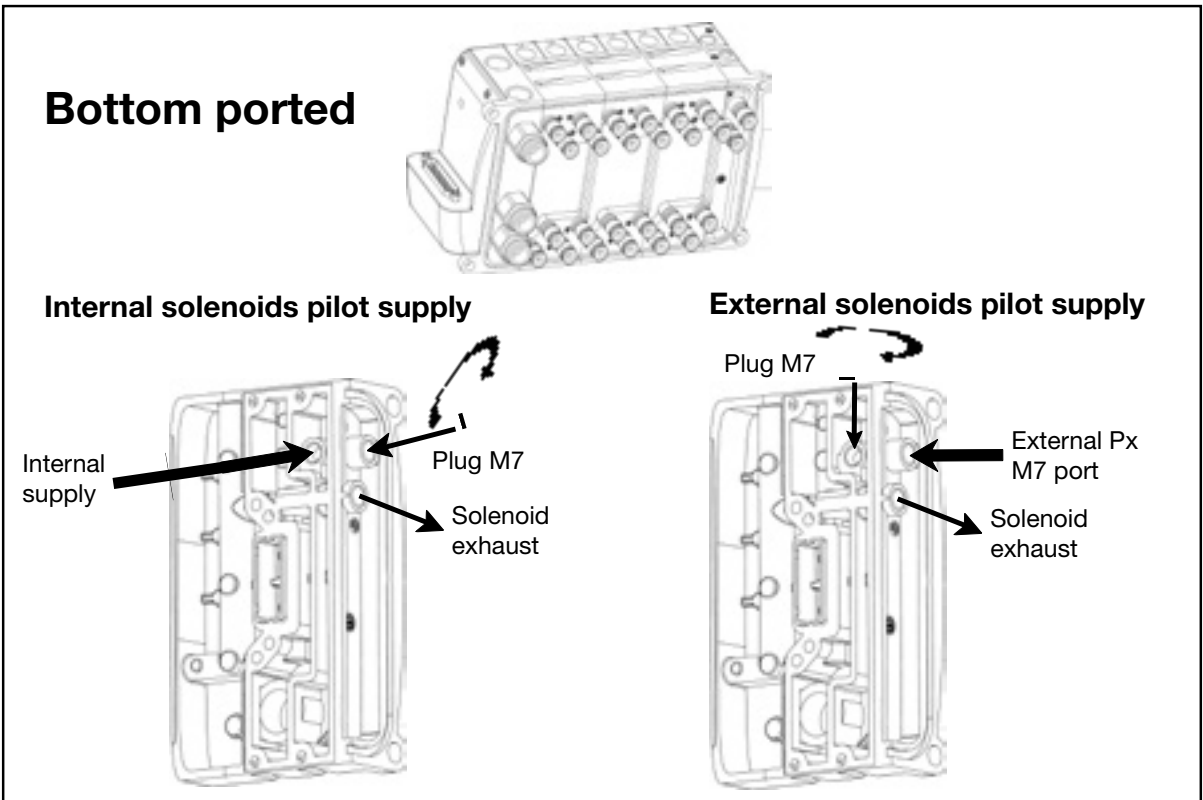
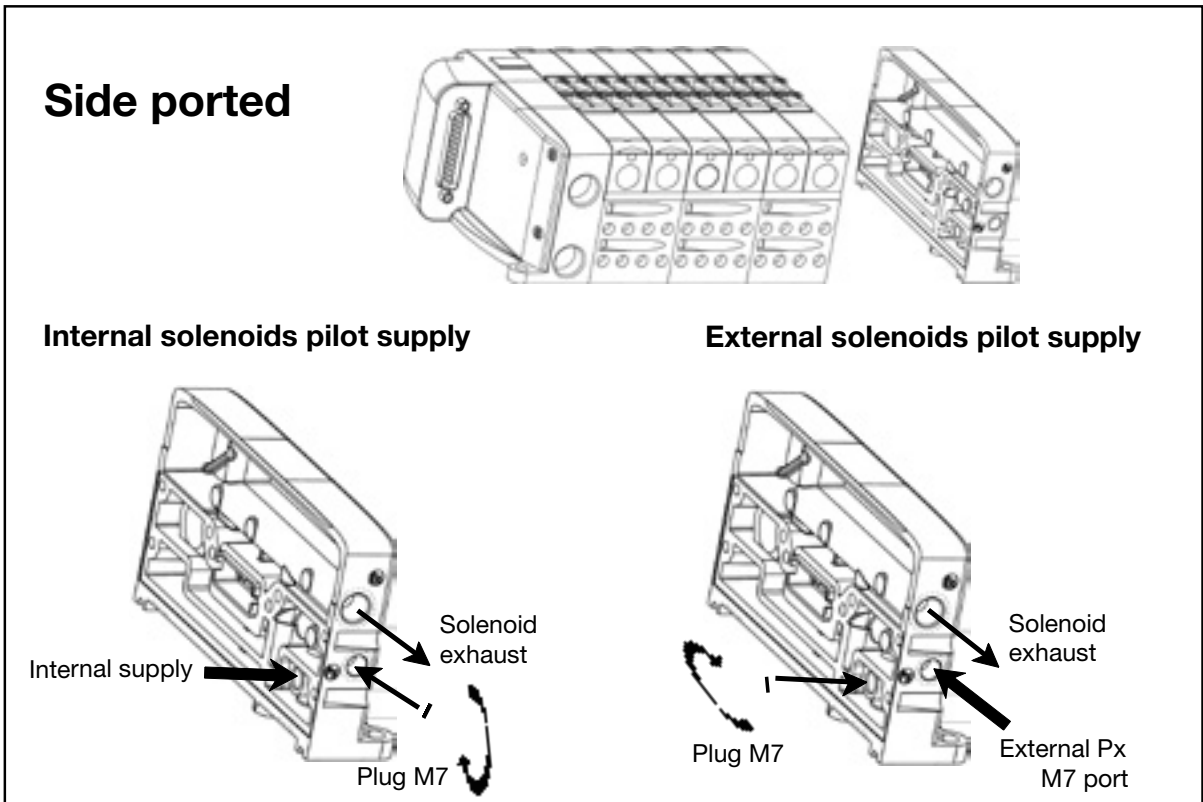

Operating pressure -0.9 to 8.3 bar, with external pilot pressure 6 bar. Solenoid pressure supply 2.7 to 8.3 bar





H Series Micro Installation & Service Instructions Sheet B

Supersedes: None

AVERTISS Danger : *Le non-respect des précautions, mises en garde, instructions et informations décrites dans le présent document ou sur le site Parker peut provoquer des dommages matériels et des blessures graves même mortelles. Des précisions complémentaires en plusieurs langues peuvent être obtenues en visitant le site web Parker: www.parker.com ou appeler le 00 800 27 27 53 74 en Europe.*

CONSIGNES GENERALES DE SECURITE

- Débrancher toujours les alimentations électrique et pneumatique du distributeur avant réglage.
- Couper toujours l'énergie de l'équipement avant réglage.
- Garder les mains et les vêtements hors de portée des points de pincement des pièces en mouvement.
- Ne jamais démonter les distributeurs sans les instructions ou manuels appropriés. Ces derniers peuvent être obtenus chez nos distributeurs ou sur le site web.

CONSIGNES GENERALES D'INSTALLATION

- S'assurer du bon positionnement des connecteurs pneumatiques dans leur logement.
- Fixer l'lot sur un bâti à l'aide des logements.
- Utiliser des tubes Parker. Ils doivent être propres, coupés droits, sans résidu, et enfoncés complètement.
- Connecter électriquement les distributeurs ou flots hors tension.
- Tester les fonctions et fuites du système. Ne jamais mettre en service sans s'assurer préalablement du bon fonctionnement et de l'absence de fuites.

ACHTUNG : *Nichtbeachten der hier und auf der Parker Website aufgezeigten Vorsichtsmaßnahmen, Hinweise, Anleitungen und Informationen kann zu Tod, Personenschäden und/oder Zerstörung der Einrichtungen führen. Genauere Informationen -in verschiedenen Sprachen- können von der Parker Website : www.parker.com abgerufen werden. T : 00 800 27 27 53 74.*

Allgemeine Sicherheitsrichtlinien

- Vor jeglicher Einstellarbeit an den Ventilen bzw. der Ventilseln sind die Druckfließleitungen zu trennen.
- Vor jeglicher Einstellarbeit an den Ventilen bzw. der Ventilseln ist der entsprechende Anlagenteil energie- und spannungslos zu machen.
- Halten Sie Abstand mit Händen und Kleidung von Klemmstellen (z.B. von Zylindern).
- Bauen Sie niemals Komponenten auseinander ohne entsprechend geeignete Anleitungen. Sie können diese erhalten von unseren Fachhändlern, eigenen Niederlassungen oder von der Webseite abrufen.

Allgemeine Installationsrichtlinien

- Drücken Sie die Einsteck-Schnellverbinder fest und sicher in die Basismodule wie gezeigt.
- Sicher Sie die Ventilseln durch Befestigungsschrauben an auf einer Montagefläche.
- Benutzen Sie nur Parker Kunststoffrohr in Verbindung mit den Schnellsteckverbindern.
Das Rohr muss sauber, rechteckig abgeschnitten, ohne lose Partikel und komplett in die Verbinder gesteckt sein.
- Stellen Sie die elektrische Verbindung in spannungslosem Zustand her.
- Testen Sie das System auf Funktion und Leckagen. Nehmen Sie das System erst in Betrieb wenn die Funktionen wie geplant ablaufen und keine Leckagen vorhanden sind.

WARNING: *Failure to follow all precautions, warnings, instructions, and information contained herein, and from the Parker website, may cause death, personal injury, and/or property damage. More detailed information, in several languages, may be obtained from the Parker website: www.parker.com or call 1-800-C PARKER in the USA or 00 800 27 27 53 74 in Europe.*

GENERAL SAFETY GUIDELINES

- Always disconnect the electric and air supply to the valve before adjusting.
- Always lockout power to machinery that the valve is attached to before adjusting.
- Keep hands and clothing away from any pinch points & paths of moving cylinders.
- Never disassemble valves without proper instruction and manuals. This may be obtained from a distributor or the website described above.

GENERAL INSTALLATION GUIDELINES

- Push plug-in pneumatic connectors securely into the modules and assemble the valve islands as shown on reverse side.
- Secure the valve or valve island using the din-rail fasteners or the mounting holes.
- Attach Parker tubing to the pneumatic connectors. Completely push clean, square-cut precision tubing into the pneumatic connectors.
- Attach electrical connections with power off.
- Test the system operation for function and leakage. Do not put into operation until the function is as intended and there is no leakage.

ADVERTENCIA: *O não cumprimento de todas as advertências, instruções e informações contidas nesta, pode causar morte, danos pessoais e/ou danos materiais. Maiores detalhes, em outras línguas, podem ser obtidos do website Parker : www.parker.com T : 00 800 27 27 53 74 (Europe).*

INSTRUÇÕES GERAIS PARA SEGURANÇA

- Sempre desconecte a eletricidade e suprimento de ar da válvula antes da regulagem ou instalação das unidades.
- Sempre desconecte a válvula de qualquer máquina/equipamento antes da regulagem ou instalação.
- Mantenha as mãos e vestuário longe de pontos onde há riscos de agarramentos ou movimentos de cilindros para evitar acidentes.
- Nunca desmonte as válvulas sem manuais e instruções apropriados. Estes podem ser obtidos da fábrica ou do website descrito anteriormente.

INSTRUÇÕES GERAIS PARA INSTALAÇÃO

- Pressione os conectores especiais dentro das unidades de válvulas como mostrado
- Instale o conjunto do manifold na superfície utilizando parafusos nos furos de montagem.
- Conecte somente tubos Parker. Estes devem estar limpos, com corte das extremidade no esquadro, sem particular soltas, e pressionadas completamente dentro das conexões.
- Faça as conexões elétricas com a linha desenergizada.
- Teste o sistema para checar o funcionamento e vazamentos. Não coloque o sistema em operação antes de checar se o funcionamento está adequado e não há vazamentos.

WAARSCHUWING: *Verzuimen tot het volgen van alle voorzorgsmaatregelen, en informaties zoals hier samengevat en op de Parker website, kan persoonlijk letsel, eigendomsschade, of zelfs de dood tot gevolg hebben. Meer detail informatie, zie www.parker.com T : 00 800 27 27 53 74 (Europe).*

Algemene veiligheidsrichtlijnen

- Altijd de lucht- en stroomtoevoer naar het ventiel afsluiten voor men gaat afstellen.
- Altijd de energie naar de machine waar het ventiel op gemonteerd zit afsluiten voor men gaat afstellen.
- Handen en kleding weghouden van de klempunten en bewegende cilinders.
- Nooit ventielen demonteren zonder de juiste instructie en handleidingen.

Algemene installatie voorschrift

- Bevestig speciale koppelingen precies zoals hierboven wordt getoond.
- Bevestig de ventielunit op ondergrond door schroeven te plaatsen.
- Alleen Parker leidingen in de koppelingen bevestigen. Deze moeten schoon en recht afgesneden zijn, zodat ze goed in de koppeling passen.
- Elektrische aansluitingen plaatsen, alleen als de voeding uit staat.
- Systeem testen op werking en lekkage, en niet in gebruik nemen voordat aan beide velden voldaan is.

PRECAUCION: *La Negligencia a los avisos de precaución, instrucciones e información contenida aquí y en el sitio Web de Parker pueden causar la muerte, daños personales y/o daño a la propiedad. Mas información detallada en diferentes idiomas pueden ser obtenidos del sitio Web de Parker: www.parker.com o llamando al teléfono 1-800-C PARKER en los Estados Unidos de América o 00 800 27 27 53 74 en Europa.*

NORMAS GENERALES DE SEGURIDAD

- Siempre desconecte el suministro de energía eléctrica y aire comprimido a la válvula antes de ajustar o instalar unidades.
- Siempre baje el interruptor de energía eléctrica de la maquinaria en la que la válvula esta instalada antes de ajustarla.
- Mantenga las manos y ropa fuera de cualquier punto apriete o partes móviles de los cilindros.
- Nunca desensamble válvulas sin los manuales o instrucciones adecuados. Estos pueden ser obtenidos de un distribuidor o del sitio Web descrito arriba.

NORMAS GENERALES DE INTALACION

- Presione los conectores especiales asegúrelos contra las bases como se muestra.
- Asegure el ensamble de manifold a la superficie usando conectores rápidos.
- Conecte solamente tubing Parker a las conexiones. Estos deberán de estar limpios, cortados en escuadra, sin particulas sueltas, y presionados completamente dentro de las conexiones.
- Realice las conexiones eléctricas con el interruptor de energía en apagado (OFF).
- Pruebe la operación del sistema verificando funcionamiento y fugas. No lo ponga en operación hasta que cumpla con la operación requerida y que no haya fugas.

VARNING: *Instruktioner, varningar och information i denna handling, och på Parkers website, skall åtdyas noggrant. Följden av att bortsä från dessa kan medföra dödsfall, personskador och/eller skador på egendom. Detaljerad information, på flera språk kan hämtas från Parkers website www.parker.com eller ring 00 800 27 27 53 74 (Europe).*

GENERELLA SÄKERHETSANVISNINGAR

- Stäng alltid av både el och luftförsörjningen innan justeringar på ventilen genomförs.
- Bryt alltid huvudströmmen till maskinen som ventilen betjänar.
- Se till att hålla undan händer och kläder från klämrisiker.
- Plocka aldrig isär en ventil utan att ha först hämtat underlag för detta från websidan eller leverantörn..

GENERELLA INSTALLATIONSANVISNINGAR

- Tryck de speciella anslutningarna ordentligt fast i underdelen, se bilden.
- Sätt fast ventillbas ordentligt på ett stabilt underlag.
- Montera enbart Parker slang i instickskopplingarna. Dessa måste skäras av rakt och vara utan s.k.skägg eller lösa partiklar samt tryckas helt in i kopplingen.
- Koppla in elen med huvudbrytaren i frånläge.
- Test systemet sedan för funktion and läckage. Starta ej maskin förrän fullgod funktion och täthet uppnåtts.

ATTENZIONE! *Il mancato rispetto delle precauzioni, avvertenze, istruzioni, ed informazioni contenute di seguito e nel sito web Parker, può provocare danni a cose o persone, anche con conseguenze letali. Per informazioni più dettagliate nelle varie lingue, consultare sito web Parker: www.parker.com o, negli Stati Uniti, chiamare il 00 800 27 27 53 74 (Europe).*

ISTRUZIONI DI SICUREZZA

- Scollegare sempre la valvola dall'alimentazione elettrica e pneumatica prima di regolare le periferiche.
- Interrompere sempre l'alimentazione elettrica ai macchinari cui la valvola è collegata prima di procedere alla regolazione.
- Tenere le mani e gli abiti lontano dai cilindri in movimento in modo che non rimangano impigliati o intrappolate.
- Non smontare mai le valvole senza aver prima seguito scrupolosamente i manuali di istruzioni che si possono richiedere al distributore, o scaricare dal sito web sopra citato.

ISTRUZIONI GENERALI D'INSTALLAZIONE

- Inserire e fissare i raccordi speciali nelle basi come indicato nel disegno.
- Fissare il manifold ad un piano mediante i dispositivi di fissaggio indicati.
- Collegare ai raccordi esclusivamente tubi Parker. I tubi devono essere puliti con le estremità tagliate a squadra, senza parti libere e inseriti nel raccordo fino in fondo.
- Attaccare le connessioni elettriche ad apparecchio spento.
- Collaudare il sistema per controllarne il funzionamento ed individuare eventuali perdite. Non utilizzare finché il funzionamento non risulta corretto e senza perdite.

Parker Worldwide

Europe, Middle East, Africa

AE – United Arab Emirates, Dubai
Tel: +971 4 8127100
parker.me@parker.com

AT – Austria, Wiener Neustadt
Tel: +43 (0)2622 23501-0
parker.austria@parker.com

AT – Eastern Europe, Wiener Neustadt
Tel: +43 (0)2622 23501 900
parker.easteurope@parker.com

AZ – Azerbaijan, Baku
Tel: +994 50 2233 458
parker.azerbaijan@parker.com

BE/LU – Belgium, Nivelles
Tel: +32 (0)67 280 900
parker.belgium@parker.com

BG – Bulgaria, Sofia
Tel: +359 2 980 1344
parker.bulgaria@parker.com

BY – Belarus, Minsk
Tel: +48 (0)22 573 24 00
parker.poland@parker.com

CH – Switzerland, Etoy
Tel: +41 (0)21 821 87 00
parker.switzerland@parker.com

CZ – Czech Republic, Klecany
Tel: +420 284 083 111
parker.czechrepublic@parker.com

DE – Germany, Kaarst
Tel: +49 (0)2131 4016 0
parker.germany@parker.com

DK – Denmark, Ballerup
Tel: +45 43 56 04 00
parker.denmark@parker.com

ES – Spain, Madrid
Tel: +34 902 330 001
parker.spain@parker.com

FI – Finland, Vantaa
Tel: +358 (0)20 753 2500
parker.finland@parker.com

FR – France, Contamine s/Arve
Tel: +33 (0)4 50 25 80 25
parker.france@parker.com

GR – Greece, Athens
Tel: +30 210 933 6450
parker.greece@parker.com

HU – Hungary, Budaörs
Tel: +36 23 885 470
parker.hungary@parker.com

IE – Ireland, Dublin
Tel: +353 (0)1 466 6370
parker.ireland@parker.com

IL – Israel
Tel: +39 02 45 19 21
parker.israel@parker.com

IT – Italy, Corsico (MI)
Tel: +39 02 45 19 21
parker.italy@parker.com

KZ – Kazakhstan, Almaty
Tel: +7 7273 561 000
parker.easteurope@parker.com

NL – The Netherlands, Oldenzaal
Tel: +31 (0)541 585 000
parker.nl@parker.com

NO – Norway, Asker
Tel: +47 66 75 34 00
parker.norway@parker.com

PL – Poland, Warsaw
Tel: +48 (0)22 573 24 00
parker.poland@parker.com

PT – Portugal
Tel: +351 22 999 7360
parker.portugal@parker.com

RO – Romania, Bucharest
Tel: +40 21 252 1382
parker.romania@parker.com

RU – Russia, Moscow
Tel: +7 495 645-2156
parker.russia@parker.com

SE – Sweden, Spånga
Tel: +46 (0)8 59 79 50 00
parker.sweden@parker.com

SL – Slovenia, Novo Mesto
Tel: +386 7 337 6650
parker.slovenia@parker.com

TR – Turkey, Istanbul
Tel: +90 216 4997081
parker.turkey@parker.com

UA – Ukraine, Kiev
Tel: +48 (0)22 573 24 00
parker.poland@parker.com

UK – United Kingdom, Warwick
Tel: +44 (0)1926 317 878
parker.uk@parker.com

ZA – South Africa, Kempton Park
Tel: +27 (0)11 961 0700
parker.southafrica@parker.com

North America

CA – Canada, Milton, Ontario
Tel: +1 905 693 3000

US – USA, Cleveland
Tel: +1 216 896 3000

Asia Pacific

AU – Australia, Castle Hill
Tel: +61 (0)2-9634 7777

CN – China, Shanghai
Tel: +86 21 2899 5000

HK – Hong Kong
Tel: +852 2428 8008

IN – India, Mumbai
Tel: +91 22 6513 7081-85

JP – Japan, Tokyo
Tel: +81 (0)3 6408 3901

KR – South Korea, Seoul
Tel: +82 2 559 0400

MY – Malaysia, Shah Alam
Tel: +60 3 7849 0800

NZ – New Zealand, Mt Wellington
Tel: +64 9 574 1744

SG – Singapore
Tel: +65 6887 6300

TH – Thailand, Bangkok
Tel: +662 186 7000

TW – Taiwan, Taipei
Tel: +886 2 2298 8987

South America

AR – Argentina, Buenos Aires
Tel: +54 3327 44 4129

BR – Brazil, Sao Jose dos Campos
Tel: +55 800 727 5374

CL – Chile, Santiago
Tel: +56 2 623 1216

MX – Mexico, Toluca
Tel: +52 72 2275 4200

European Product Information Centre

Free phone: 00 800 27 27 5374

(from AT, BE, CH, CZ, DE, DK, EE, ES, FI, FR, IE, IL, IS, IT, LU, MT, NL, NO, PL, PT, RU, SE, SK, UK, ZA)

© 2019 Parker Hannifin Corporation. All rights reserved.

Catalogue PDE2597TCUK - V7 - November 2019

Parker Hannifin Ltd.

Tachbrook Park Drive
Tachbrook Park,
Warwick, CV34 6TU
United Kingdom
Tel.: +44 (0) 1926 317 878
Fax: +44 (0) 1926 317 855
parker.uk@parker.com
www.parker.com



Your local authorized Parker distributor