

### General Description

Series VBY pilot operated sequence valves consist of a pilot with manual adjustment and a main part with spool execution. The valve has an external drain.

This valve can also be used as a pressure relief valve. Please observe hydraulic connection.

### Features

- Manifold mounting acc. to ISO 5781
- Type VBY with external drain
- Main stage spool type valve
- Pilot stage seated type valve
- 4 pressure ranges
- 2 adjustment modes
  - Screw with hexagon socket
  - DIN knob

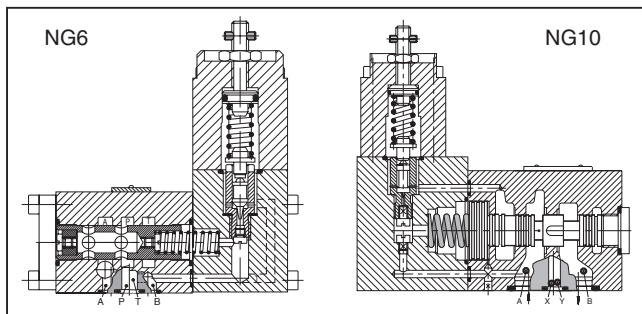
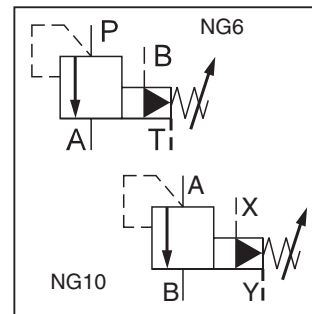

### Specifications

Size	NG6	NG10
Mounting Pattern	ISO 5781	
Mounting Position	As desired	
Ambient Temperature	-20°C to +80°C (-4°F to +176°F)	
Operating Pressure, Ports External Drain Port Pressure	P, A, B up to 315 Bar (4568 PSI) T up to 100 Bar (1450 PSI)	A, B, X up to 315 Bar (4568 PSI) Y up to 100 Bar (1450 PSI)
Pressure Range	64, 160, 210, 315 Bar (928, 2320, 3045, 4568 PSI)	
Pressure Fluid Temperature	-20°C to +70°C (-4°F to +158°F)	
Viscosity Range Recommended Permitted	30 to 50 cSt / mm <sup>2</sup> /s (139 to 232 SSU) 20 to 380 cSt / mm <sup>2</sup> /s (93 to 1761 SSU)	
Filtration	ISO 4406 (1999), 18/16/13	
Pilot Oil Flow	approx. 500 cm <sup>3</sup> /min	approx. 1000 cm <sup>3</sup> /min

### Ordering Information

<div style="border: 1px solid black; padding: 2px; width: 40px; margin: 0 auto;">VBY</div> <p>Pressure Relief Valve</p>	<div style="border: 1px solid black; width: 40px; height: 40px; margin: 0 auto;"></div> <p>Pressure Range</p>	<div style="border: 1px solid black; width: 40px; height: 40px; margin: 0 auto;"></div> <p>Adjustment</p>	<div style="border: 1px solid black; width: 40px; height: 40px; margin: 0 auto;"></div> <p>Size</p>	<div style="border: 1px solid black; width: 40px; height: 40px; margin: 0 auto;"></div> <p>Seal</p>	<div style="border: 1px dashed black; width: 40px; height: 40px; margin: 0 auto;"></div> <p>Design Series</p> <p>NOTE: Not required when ordering.</p>																												
<table border="0" style="width: 100%;"> <thead> <tr> <th style="text-align: left;">Code</th> <th style="text-align: left;">Description</th> </tr> </thead> <tbody> <tr><td>064</td><td>64 Bar (928 PSI)</td></tr> <tr><td>160</td><td>160 Bar (2320 PSI)</td></tr> <tr><td>210</td><td>210 Bar (3045 PSI)</td></tr> <tr><td>315</td><td>315 Bar (4568 PSI)</td></tr> </tbody> </table>	Code	Description	064	64 Bar (928 PSI)	160	160 Bar (2320 PSI)	210	210 Bar (3045 PSI)	315	315 Bar (4568 PSI)	<table border="0" style="width: 100%;"> <thead> <tr> <th style="text-align: left;">Code</th> <th style="text-align: left;">Description</th> </tr> </thead> <tbody> <tr><td>A</td><td>Adjustment Screw with Hexagon Socket</td></tr> <tr><td>H</td><td>Turning Knob with Cylinder Lock</td></tr> </tbody> </table>	Code	Description	A	Adjustment Screw with Hexagon Socket	H	Turning Knob with Cylinder Lock	<table border="0" style="width: 100%;"> <thead> <tr> <th style="text-align: left;">Code</th> <th style="text-align: left;">Description</th> </tr> </thead> <tbody> <tr><td>06</td><td>NG6</td></tr> <tr><td>10</td><td>NG10</td></tr> </tbody> </table>	Code	Description	06	NG6	10	NG10	<table border="0" style="width: 100%;"> <thead> <tr> <th style="text-align: left;">Code</th> <th style="text-align: left;">Description</th> </tr> </thead> <tbody> <tr><td>N</td><td>Nitrile</td></tr> <tr><td>V</td><td>Fluorocarbon</td></tr> </tbody> </table>	Code	Description	N	Nitrile	V	Fluorocarbon		
Code	Description																																
064	64 Bar (928 PSI)																																
160	160 Bar (2320 PSI)																																
210	210 Bar (3045 PSI)																																
315	315 Bar (4568 PSI)																																
Code	Description																																
A	Adjustment Screw with Hexagon Socket																																
H	Turning Knob with Cylinder Lock																																
Code	Description																																
06	NG6																																
10	NG10																																
Code	Description																																
N	Nitrile																																
V	Fluorocarbon																																

**Weight:**  
VBY\*06 2.4 kg (5.29 lbs.)  
VBY\*10 4.5 kg (9.92 lbs.)

**WARNING:** This product can expose you to chemicals including Lead, Nickel (Metallic), or 1,3-Butadiene which are known to the State of California to cause cancer, and Lead or 1,3-Butadiene which is known to the State of California to cause birth defects and other reproductive harm. For more information go to [www.P65Warnings.ca.gov](http://www.P65Warnings.ca.gov).

**VB Y\*06**

p/Q measured at t = 50°C (122°F) and  $\nu = 36\text{mm}^2/\text{s}$

**D**

**Maximum Setting Range**  
**64 Bar (928 PSI)**

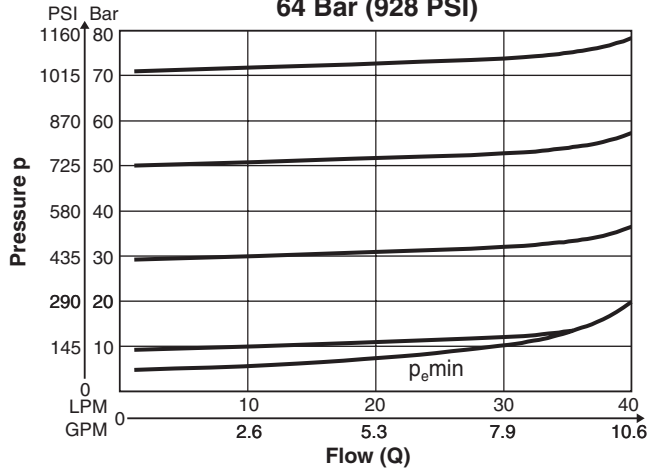

**Maximum Setting Range**  
**210 Bar (3045 PSI)**

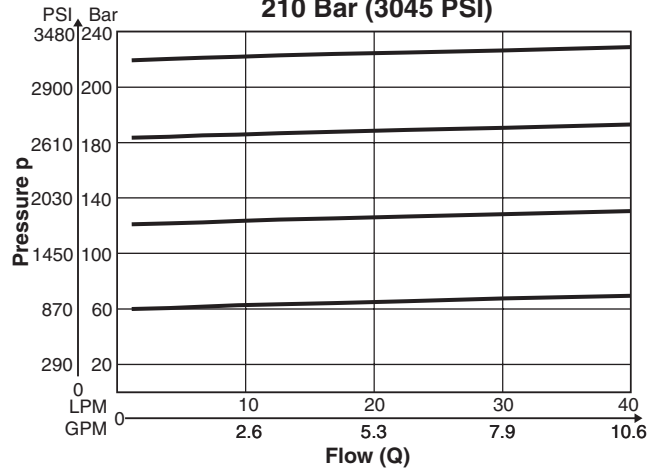

**Maximum Setting Range**  
**160 Bar (2320 PSI)**

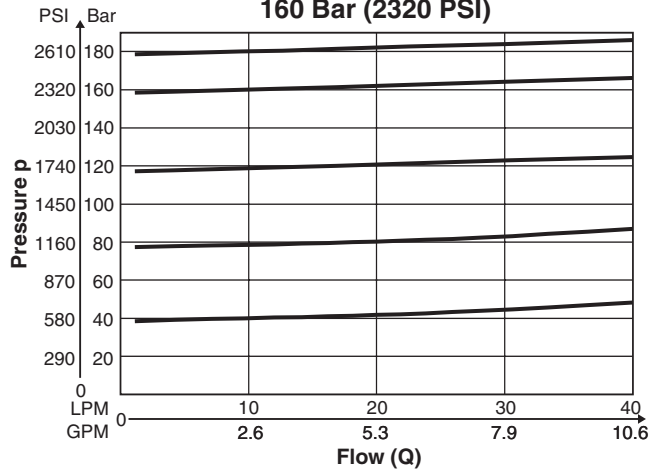

**Maximum Setting Range**  
**315 Bar (4568 PSI)**

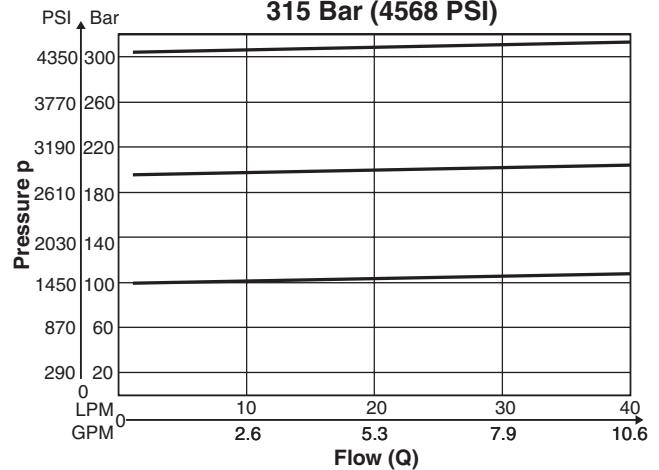

**VB Y\*10**

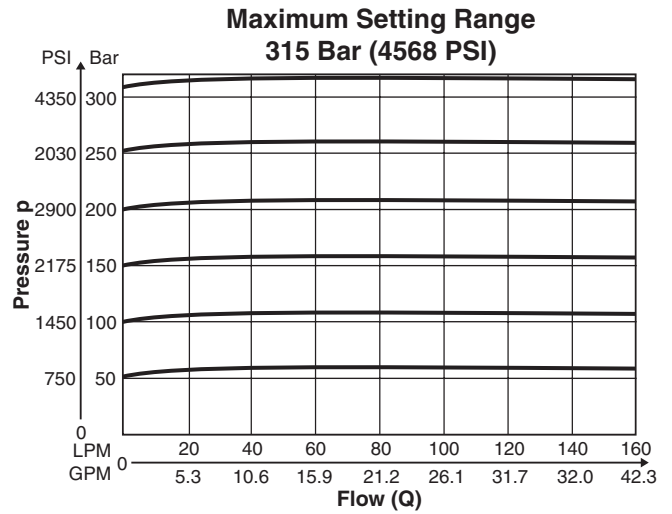
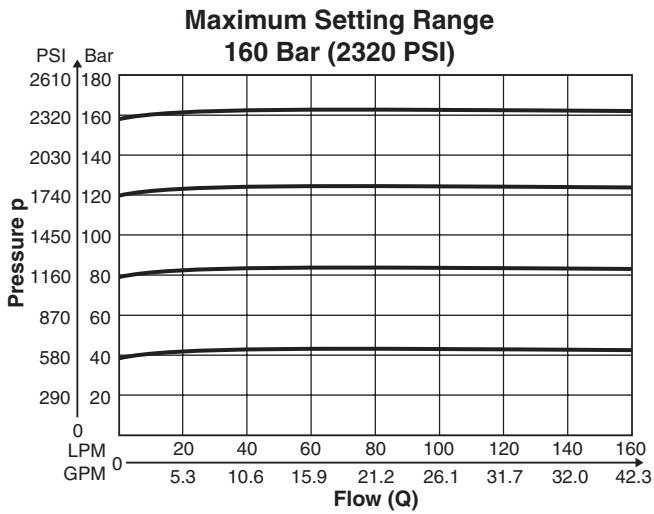
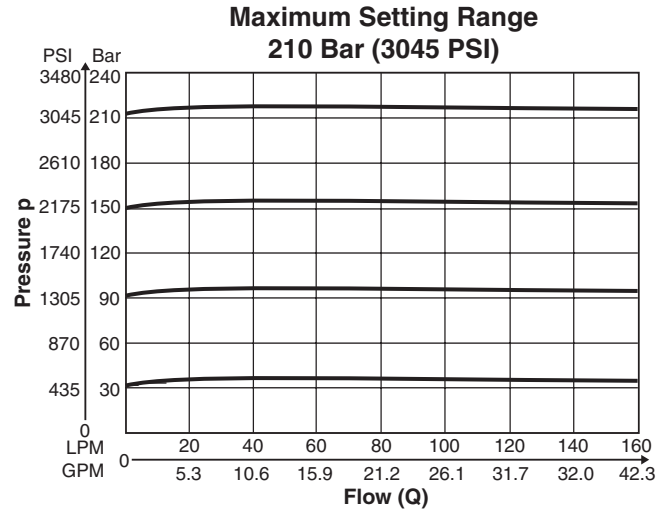
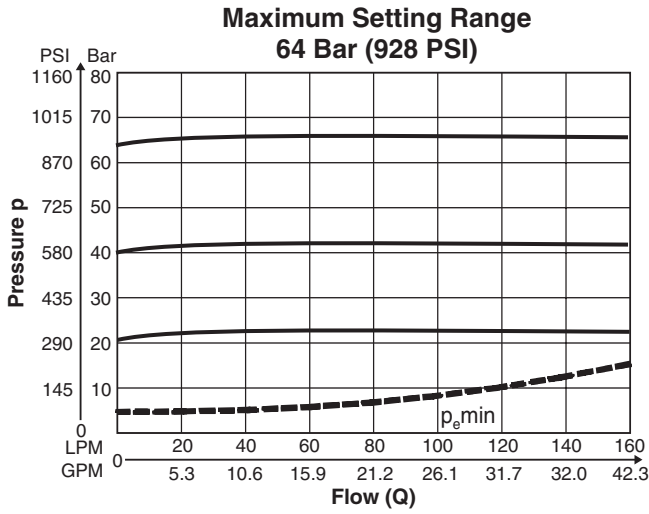

p/Q measured at t = 50°C (122°F) and v = 36mm<sup>2</sup>/s

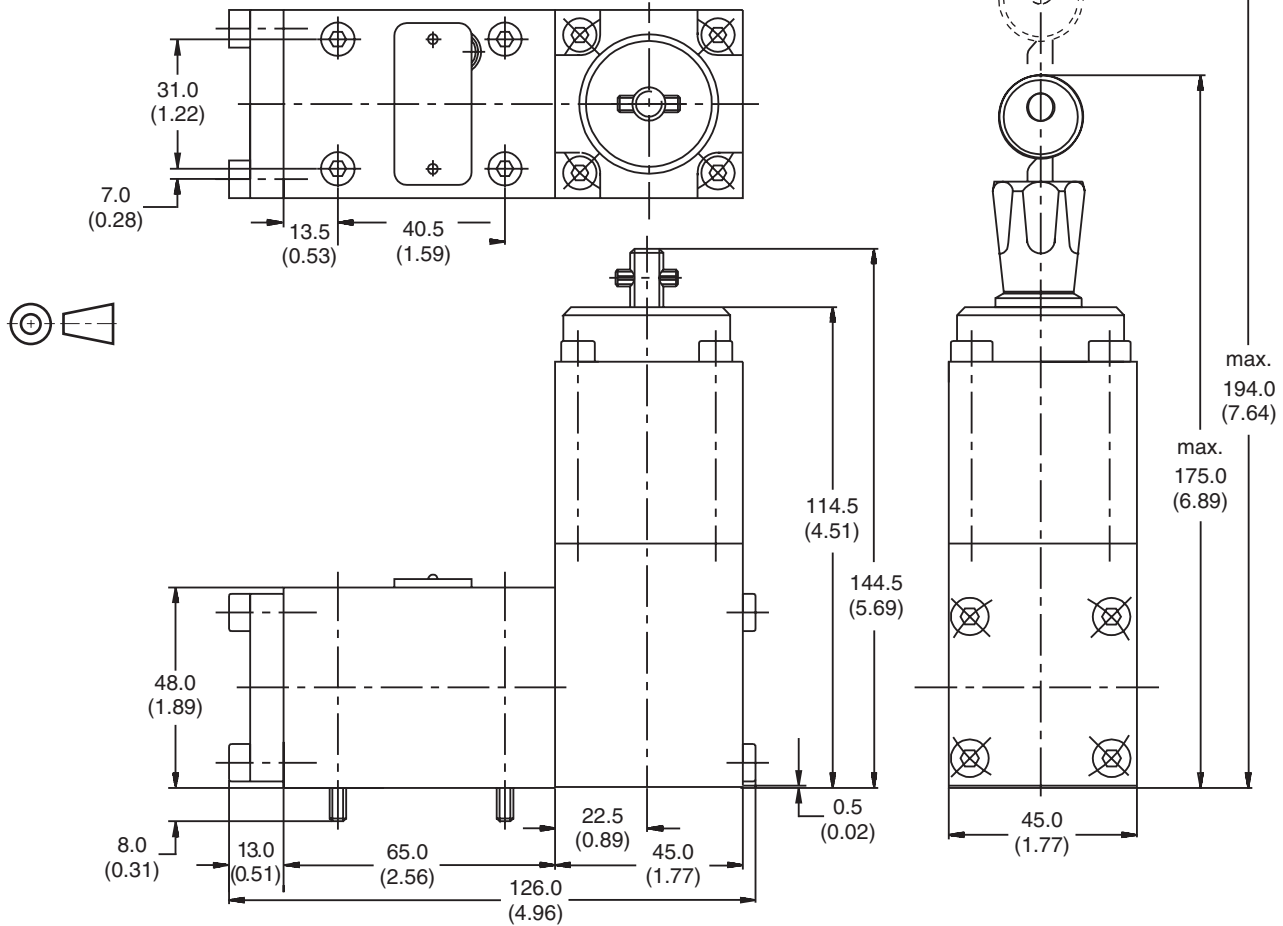

**VBY\*06**

Inch equivalents for millimeter dimensions are shown in (\*\*)

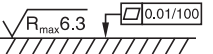

<b>Surface Finish</b>	<b>Bolt Kit</b>  <b>DIN912 12.9</b>		<b>Seal Kit</b> 
	BK375 4x M5x30	7.5 Nm (5.5 lb.-ft.)	Nitrile: SK-VB/VM/VS Fluorocarbon: SK-VB/VM/VS V

**Mounting Pattern ISO 5781-03-04-0-00  
(NFPA D03, CETOP 3, NG6)**

Inch equivalents for millimeter dimensions are shown in (\*\*)

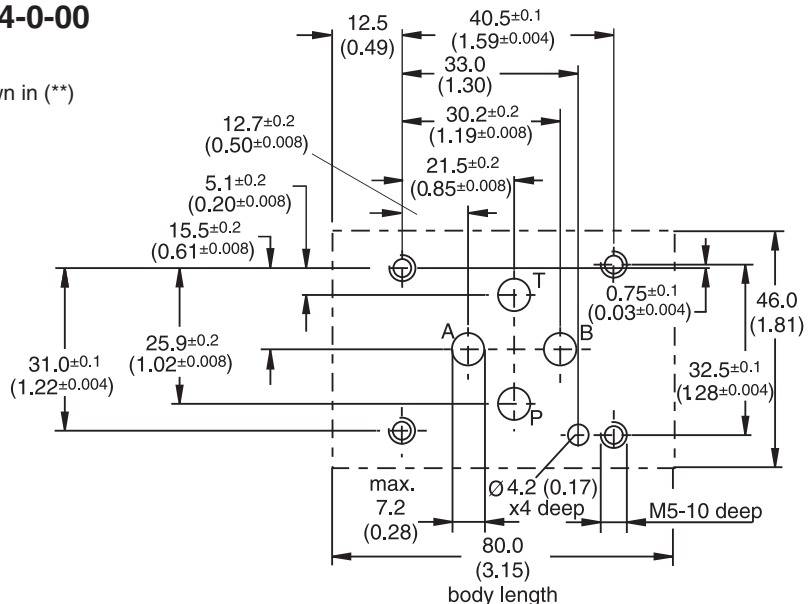



**VBY\*10**

Inch equivalents for millimeter dimensions are shown in (\*\*)

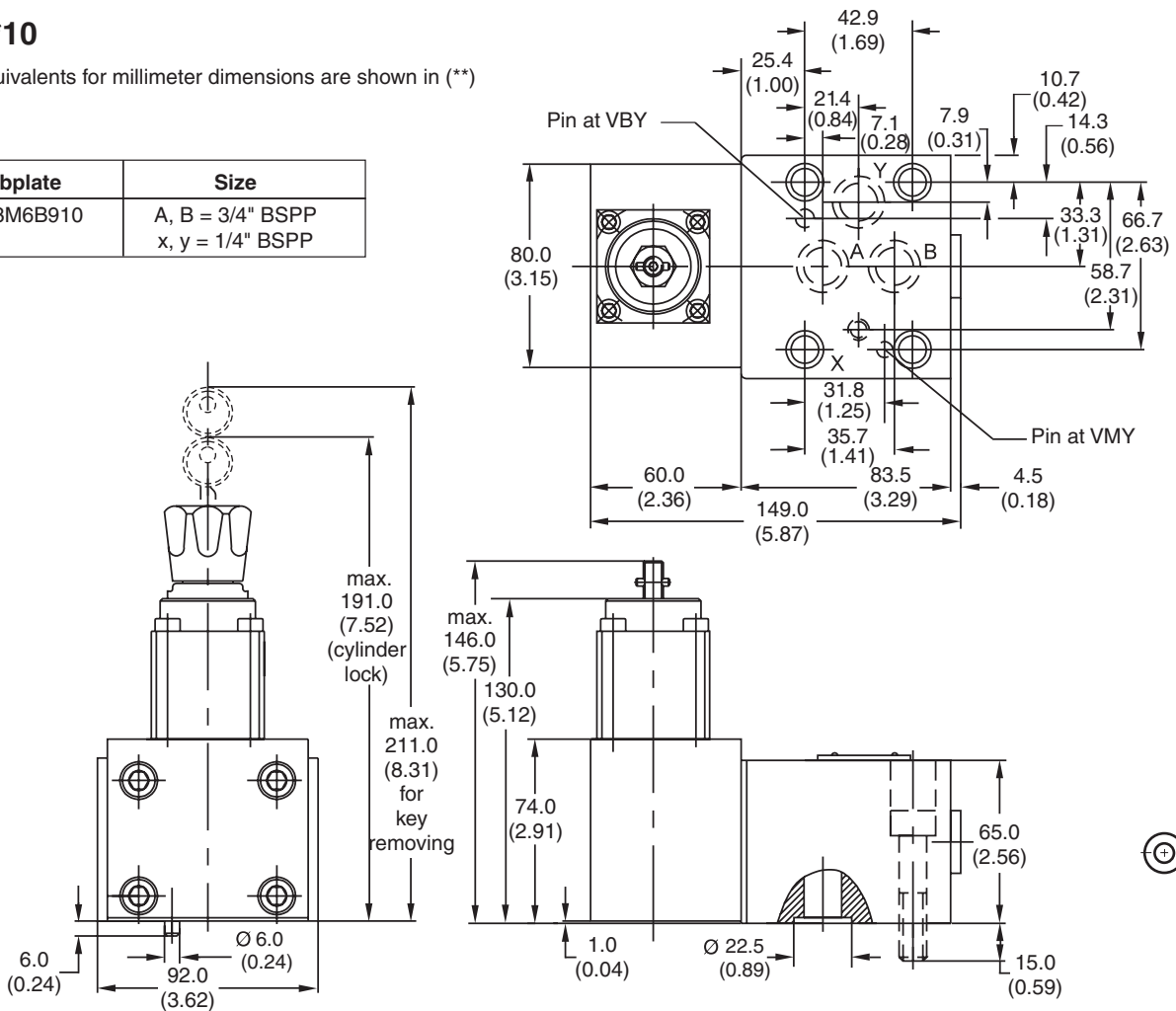
Subplate	Size
SPP3M6B910	A, B = 3/4" BSPP x, y = 1/4" BSPP

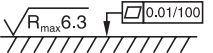

Surface Finish	Bolt Kit  DIN912 12.9	 65 Nm (47.9 lb.-ft.)	Seal  Kit
	BK389 4x M10x50		Nitrile: SK-VB/VM-A10 Fluorocarbon: SK-VB/VM-A10V

**Mounting Pattern ISO 5781-06-07-0-00**

Inch equivalents for millimeter dimensions are shown in (\*\*)

