

Characteristics

Direct operated, spool-type sandwich DC valves series Z1DW size NG06 are used for shutting off the flow in stack systems.

For shut off secondary ports A and B, body version A is applied. P and T are drilled through.

For applications with port B drained in a switching position to tank, body version B is used. P and A are drilled through.

Valves are sealed to the manifold side.

The valves can be ordered with inductive position control optionally.

Attention:
The adjustment of the position control is factory set and sealed. Replacement and repairs can only be undertaken by the manufacturer.

Technical Features

- Shut-off sandwich valve NG06
- Inductive position control optional



Z1DW*E standard



Z1DW*E ind. position control

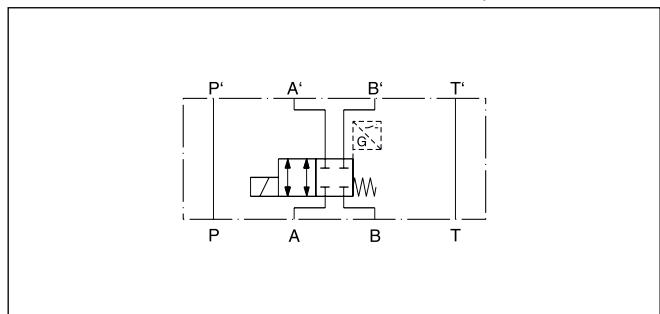

Z1DWA02E

7

Z1DW*E without inductive position control

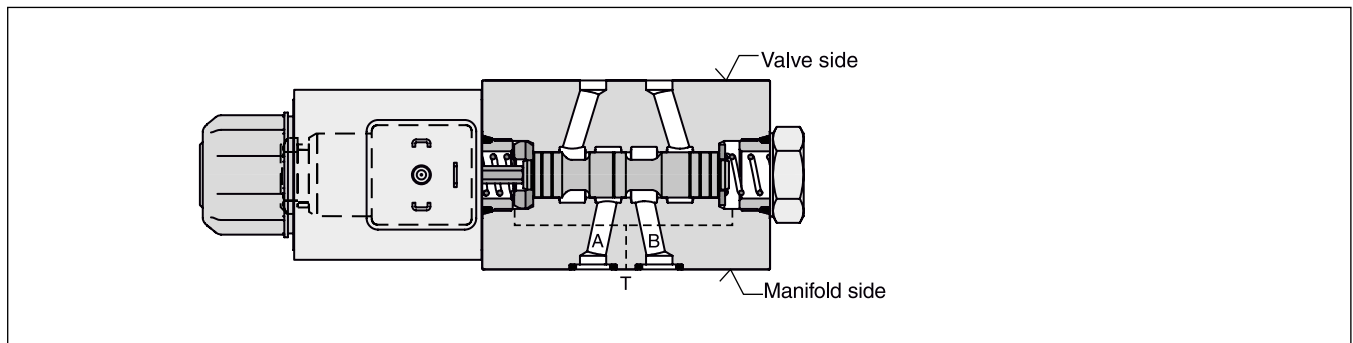

Z1DW*E with inductive position control

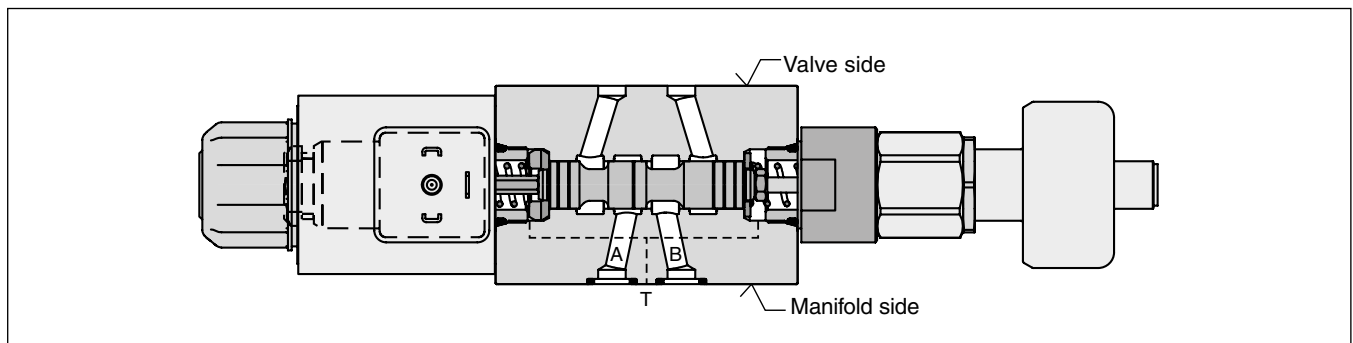

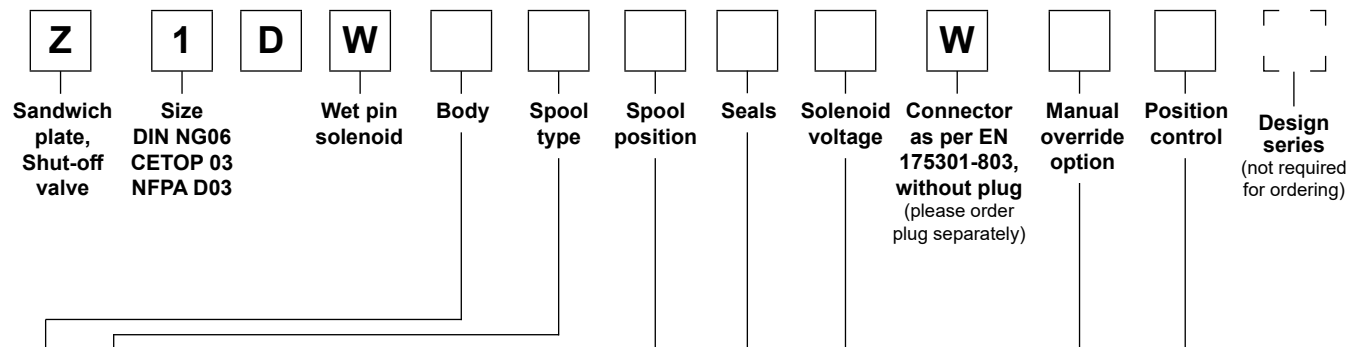

Code	Code	Code	
A	01	C ¹⁾	
A	01	E	
A	01	K	
A	02	C ¹⁾	
A	02	E	
A	02	K	
A	03	K	
A	04	E	
B	37	B	

Code	Position control	Spool position
omit	Standard	C, E, B, K
I2N ⁴⁾	End position monitored side B	E, B (Solenoid on a-side)
I5N ³⁾⁴⁾	Start position monitored side B	
I1N ⁴⁾	End position monitored side A	K (Solenoid on b-side)
I4N ³⁾⁴⁾	Start position monitored side A	

Code	Manual override
omit	Standard valve with manual override
T ³⁾	without manual override

Code	Voltage
K	12 V =
J	24 V =
U ²⁾	98 V =
G ²⁾	205 V =

Code	Seals
N	NBR
V	FPM

Further spool types and voltages on request.

- 1) Without position control.
- 2) To be used in combination with rectifier plugs at 120 VAC / 230 VAC power supply.
- 3) For hydraulic presses according to the safety regulations DIN EN ISO 16092-3, manual override code "T" (without manual override) and position control "I4N" or "I5N" (start position monitored) are required.
- 4) Please order female connector M12x1 separately (see accessories in chapter 2, female connector M12x1 (order no.: 5004109).

General					
Design	Directional spool valve, sandwich type				
Actuation	Solenoid				
Size	DIN NG06 / CETOP 03 / NFPA D03				
Mounting interface	DIN 24340 A6 / ISO 4401 / CETOP RP 121-H / NFPA D03				
Mounting position	unrestricted, preferably horizontal				
Ambient temperature	[°C]	-20...+60			
MTTF _D value	[years]	150			
Weight	[kg]	1.8 (1 solenoid), 2.3 (2 solenoids) w/o position control			
	[kg]	2 with position control			
Hydraulic					
Max. operating pressure	[bar]	P, A B: 350 ; T: 210			
Fluid	Hydraulic oil in accordance with DIN 51524				
Fluid temperature	[°C]	-20...+70 (NBR: -25...+70)			
Viscosity, permitted	[cSt] / [mm ² /s]	20...400			
	recommended	[cSt] / [mm ² /s]	30...80		
Filtration	ISO 4406 (1999); 18/16/13				
Flow max.	[l/min]	50			
Leakage at 50 bar	[ml/min]	Up to 10 per flow path, depending on spool			
Static / Dynamic					
Step response at 95 %	[ms]	Energized: 32 ; De-energized: 40			
Electrical characteristics					
Duty ratio	100 % ED; CAUTION: coil temperature up to 150 °C possible				
Max. switching frequency	[1/h]	15000			
Protection class	IP 65 in accordance with EN 60529 (with correctly mounted plug-in connector)				
	Code	K	J	U	G
Supply voltage	[V]	12 V =	24 V =	98 V =	205 V =
Tolerance supply voltage	[%]	±10	±10	±10	±10
Current consumption	[A]	2.72	1.29	0.33	0.13
Power consumption	[W]	32.7	31	31.9	28.2
Solenoid connection	Connector as per EN 175301-803, solenoid identification as per ISO 9461.				
Wiring min.	[mm ²]	3 x 1.5 recommended			
Wiring length max.	[m]	50 recommended			

With electrical connections the protective conductor (PE \perp) must be connected according to the relevant regulations.

Electrical characteristics of position control as per IEC 61076-2-101 (M12x1)

Supply voltage	[VDC]	24
Tolerance supply voltage	[%]	±20
Ripple supply voltage	[%]	≤10
Polarity protection	[V]	300
Current consumption without load	[mA]	≤20
Switching hysteresis	[mm]	<0.06
Max. output current per channel, ohmic	[mA]	250
Ambient temperature	[°C]	-20 ... +60
Protection		IP65 acc. EN 60529 (with correctly mounted plug-in connector)
Min. distance to next AC solenoid	[m]	0.1
Interface		M12x1 to IEC 61076-2-101
CE conform		EN 61000-4-2 / EN 61000-4-4 / EN 61000-4-6 ¹⁾ / ENV 50140 / ENV 50204

M12 pin assignment

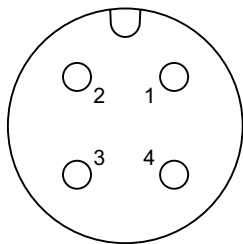

- 1 + U_S 19.2...28.8 V
- 2 Out B: normally open
- 3 0V
- 4 Out A: normally closed

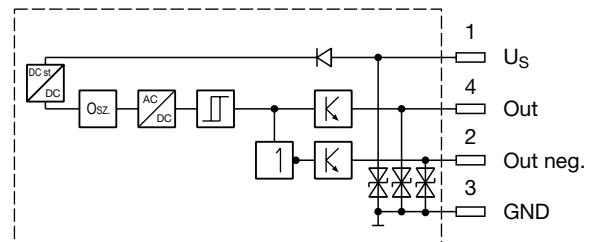

Outputs: Open collector

Definitions

Start position monitored:

The valve is de-energized. The inductive switch gives a signal at the moment when the spool leaves the spring offset position (below 25 % spool stroke).
 At the switching point the spool is located within the closed position. It is secured that only the flow paths of the offset position are granted.

End position monitored:

The inductive switch gives a signal before the end position is reached (above 75 % spool stroke).

The switch can only be located on the opposite side of the solenoid for direct operated valves.
 Please order plug M12 x 1 separately (see accessories, plug M12x1; order no.: 5004109).

¹⁾ Only guaranteed with screened cable and female connector

The flow curve diagram shows the flow versus pressure drop curves for all spool types. The relevant curve number

for each spool type, operating position and flow direction is given in the table below.

Spool	Symbol	A-A'	A'-A	B-B'	B'-B	T-T'	T-T' Start position	T-T' End position	P-P'	B-T	A-B	B-A
A01C A01K		5	5	5	5	1	—	—	1	—	5	5
A02C A02E		5	5	5	5	1	—	—	1	—	5	5
A03K		4	4	6	6	1	—	—	1	—	6	6
A04E		6	6	4	4	1	—	—	1	—	6	6
B37B		2	2	4	4	—	3	1	1	6	—	—

7

Flow curves

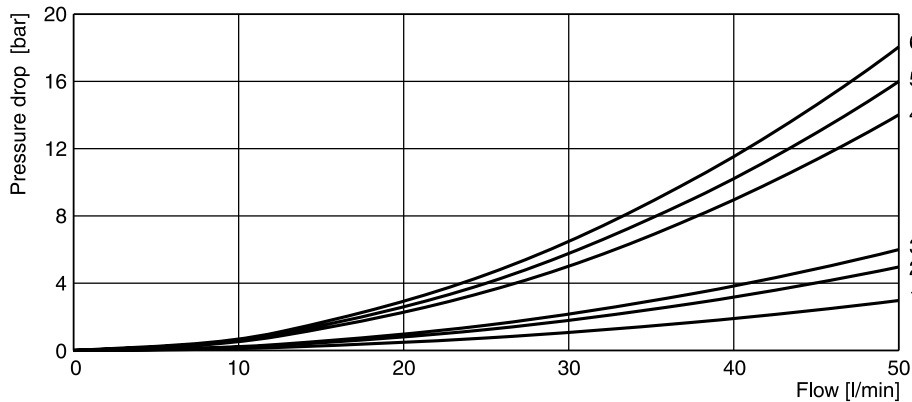

Shift limits

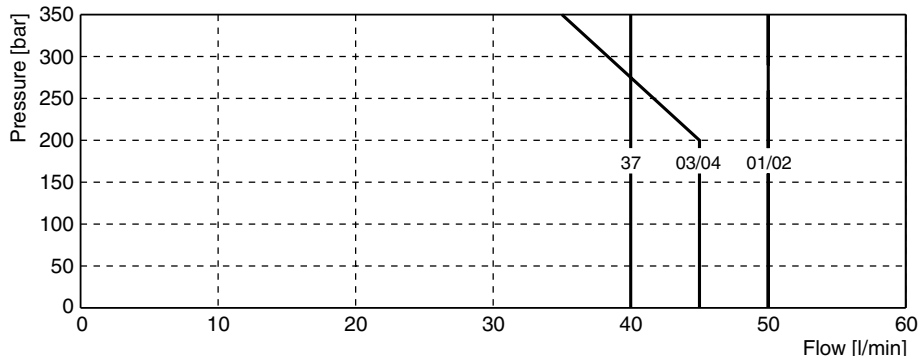

Measured with HLP46 at 50 °C, 90 % U_{nom} and warm solenoids.

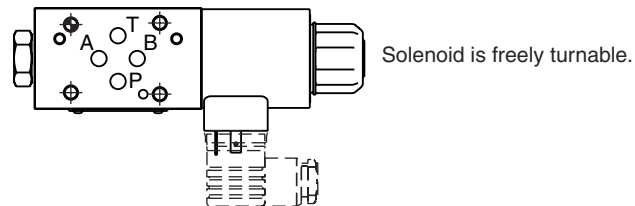
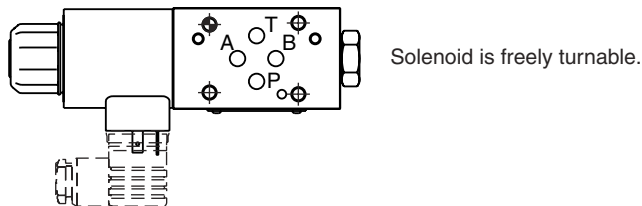
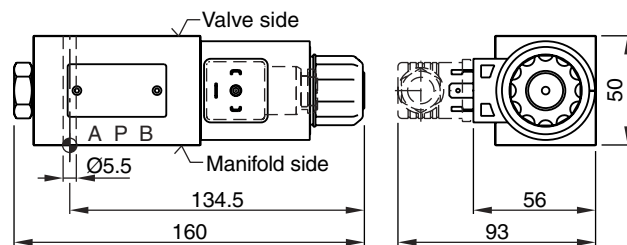
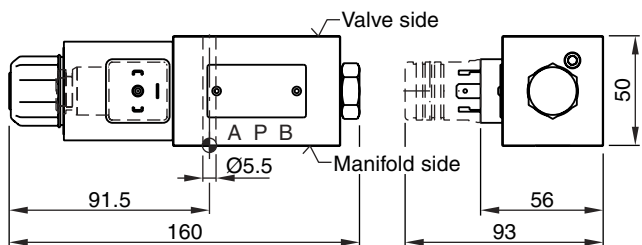

**Z1DW Standard
 B, E -style**

K -style

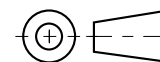
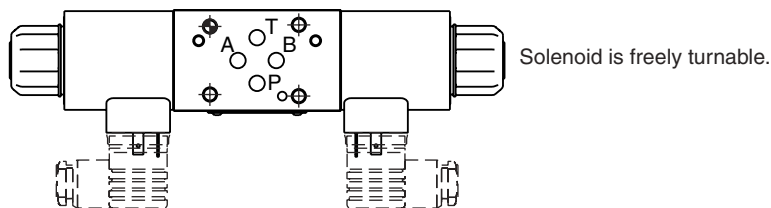
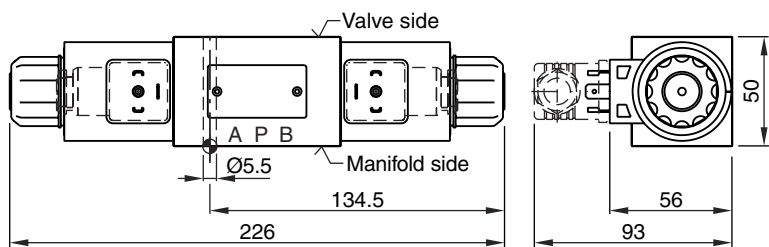

C -style

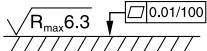

Surface finish		 Kit
	7.6 Nm ±15 %	NBR: SK-D1VW-N91 FPM: SK-D1VW-V91

The space necessary to remove the plug per EN 175301-803, design type AF is at least 15 mm.
 The torque for the screw M3 of the plug has to be 0.5 to 0.6 Nm.

Z1DW with inductive position control
 Interface EN 175301-803, DC solenoid, without plug M12x1 ¹⁾
B, E -style

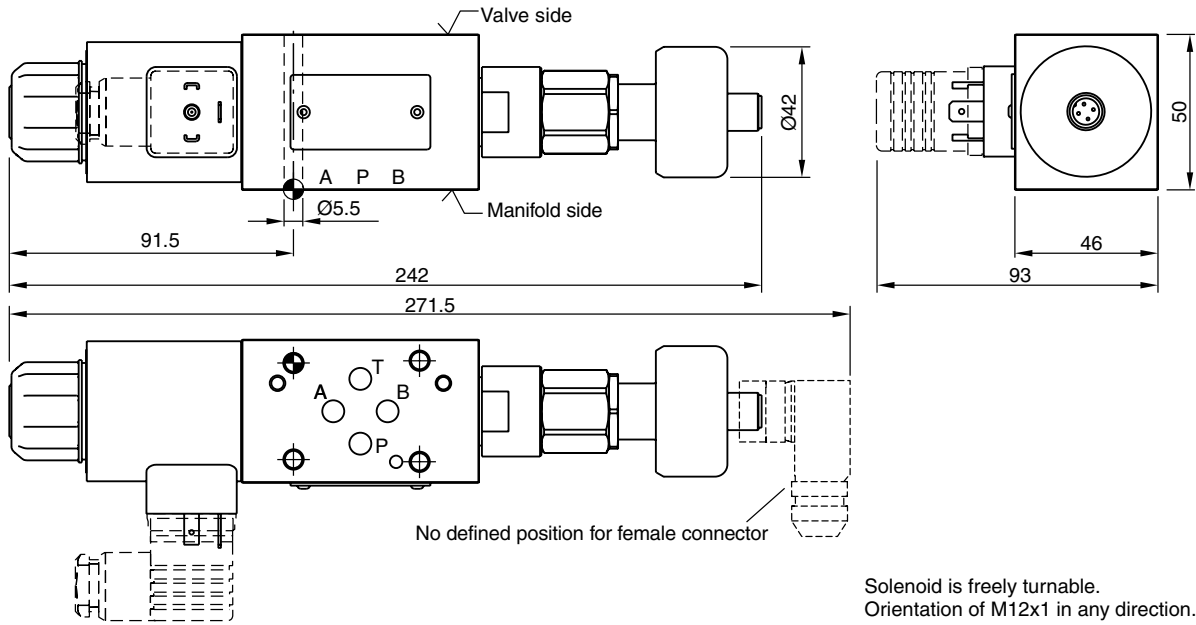

Solenoid is freely turnable.
 Orientation of M12x1 in any direction.

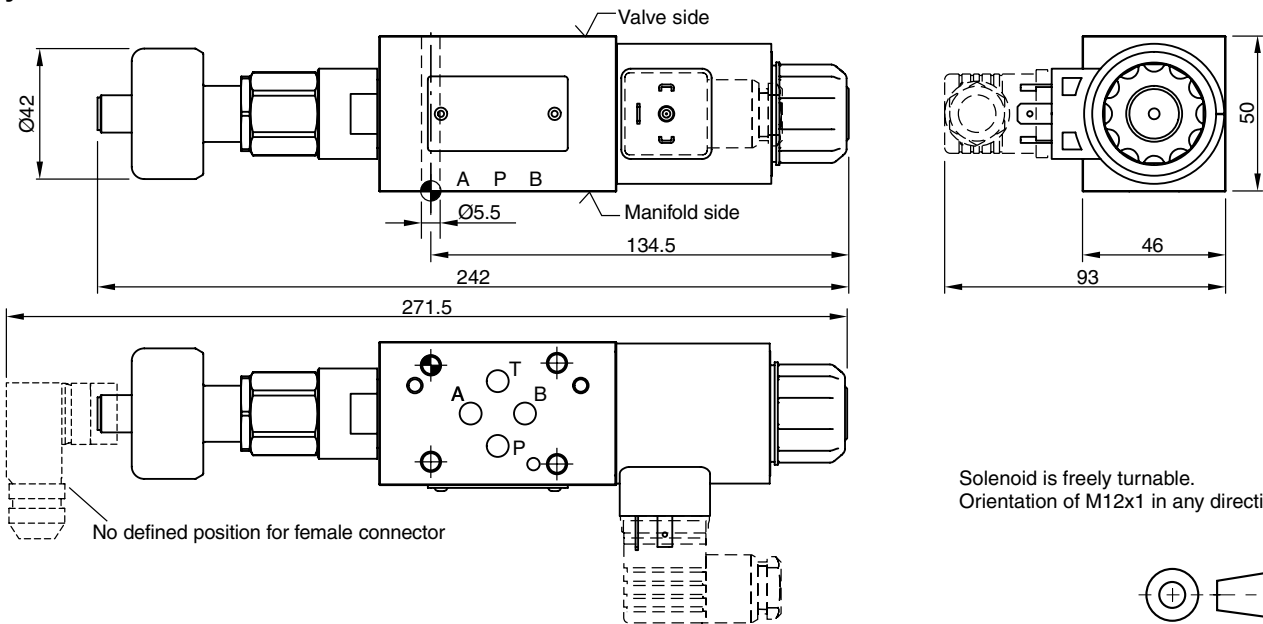

K -style

7

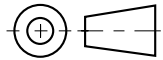

Solenoid is freely turnable.
 Orientation of M12x1 in any direction.

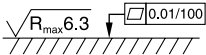

Surface finish		 Kit
	7.6 Nm ±15 %	NBR: SK-D1VW-N91 FPM: SK-D1VW-V91

The space necessary to remove the plug per EN 175301-803, design type AF is at least 15 mm.

The torque for the screw M3 of the plug has to be 0.5 to 0.6 Nm.

Attention: The adjustment of the position control is factory set and sealed. Replacement and repairs can only be undertaken by the manufacturer.

¹⁾ Please order plug M12 x 1 separately (see accessories, plug M12x1; order no.: 5004109).