

CCIMS

Close Coupled Instrument Mounting System

aerospace
climate control
electromechanical
filtration
fluid & gas handling
hydraulics
pneumatics
process control
sealing & shielding











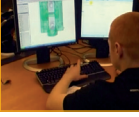

ENGINEERING YOUR SUCCESS.

Introduction

Parker Hannifin's response to the constant demand for higher performance in flow measurement is the introduction of a breakthrough in process control: CCIMS – Close Coupled Instrument Mounting System; A radical and standardised solution for direct-mounting differential pressure transmitters to piping flanges.

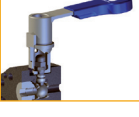
Contents

Page 3	CCIMS: The Concept	
Page 4/5	CCIMS: The Benefits	
Page 6/7	Design and Test References	
Page 8	Solution Configurations	
Page 9	Primary (Isolation) Module Options	
Page 10-12	Secondary (Instrument) Module Options	
Page 13	Auxiliary Modules & Options	
Page 14/15	How to Order	
Page 16/17	Valve Design & Performance Properties	
Page 18/19	Basic Installation Guide	

CCIMS: The Concept

CCIMS supports the direct or close coupled' connection of one of the most common types of process instruments – differential pressure (DP) transmitters – to process pipework.

CCIMS combines an instrument manifold and a pipe interface (including isolation valves) and provides a standard means of connecting instruments with huge cost, performance and safety advantages.

Design

CCIMS has been designed using tried and tested standard components from our current ball, needle and rising plug valves ranges. All the designs meet the relevant industry standard design codes.

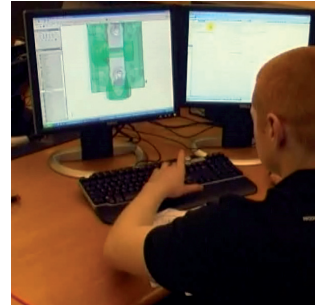

Manufacturing

A state of the art manufacturing cell has been established within our UK manufacturing facility to support CCIMS.



Testing

CCIMS meets all relevant industry design codes. All components and complete assemblies meet a 4:1 pressure test requirement and have been rigorously tested.

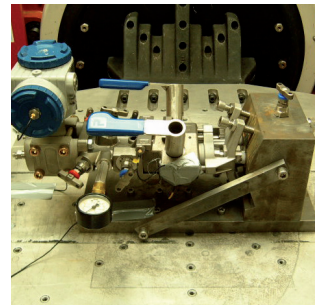

WARNING

FAILURE, IMPROPER SELECTION OR IMPROPER USE OF THE PRODUCTS AND/OR SYSTEMS DESCRIBED HEREIN OR RELATED ITEMS CAN CAUSE DEATH, PERSONAL INJURY AND PROPERTY DAMAGE.

This document and other information from Parker Hannifin Corporation, its subsidiaries and authorized distributors provide product and/or system options for further investigation by users having technical expertise. It is important that you analyze all aspects of your application and review the information concerning the product or system in the current product catalog. Due to the variety of operating conditions and applications for these products or systems, the user, through its own analysis and testing, is solely responsible for making the final selection of the products and systems and assuring that all performance, safety and warning requirements of the application are met.

The products described herein, including without limitation, product features, specifications, designs, availability and pricing, are subject to change by Parker Hannifin Corporation and its subsidiaries at any time without notice.

Offer of sale

The items described in this document are available for sale by Parker Hannifin Corporation, its subsidiaries or its authorized distributors. Any sale contract entered by Parker will be governed by the provisions stated in Parker's standard terms and conditions of sale (copy available upon request).

CCIMS: The Benefits

Installation

The use of CCIMS will bring significant cost savings to plant operators and installers.

Instrument 'Hook-ups' can vary widely but they typically necessitate an assembly time of at least 12 hours (other estimates put this time to nearer 29 hours).

Mounting a CCIMS solution takes only half an hour, saving at least 75% of the installation time.

Safety

A traditional 'hook-up' for flow measurement can involve up to 40 connections, each of which is a potential leak path.

A CCIMS solution reduces this to just 5 – a massive leap in integrity that helps to avoid the human and environmental safety issues caused by leakages or emissions.

Potential leak paths can be reduced by 75%.

Maintenance

With the elimination of impulse lines, when using CCIMS removes the potential problem of lines blocking, plugging or freezing.

Should the instrument need to be removed for calibration, maintenance or replacement this is able to be done literally in seconds because of the unique 'Phastfit' interlocked connection interface, which also significantly reduces the plant downtime.

System Accuracy

Users now require high levels of reliability and integrity and the performance advantages are a major attraction.

With traditional impulse line arrangements, the length of the flow path, the volume of the system, the bends, elbows, tees and valves etc. can all introduce pressure drops and turbulence/flow variations (hydrostatic errors) that lead to measurement inaccuracies, or gauge line error, which can give inaccuracies of up to 15%.

The straight through flow path of CCIMS removes these problems.

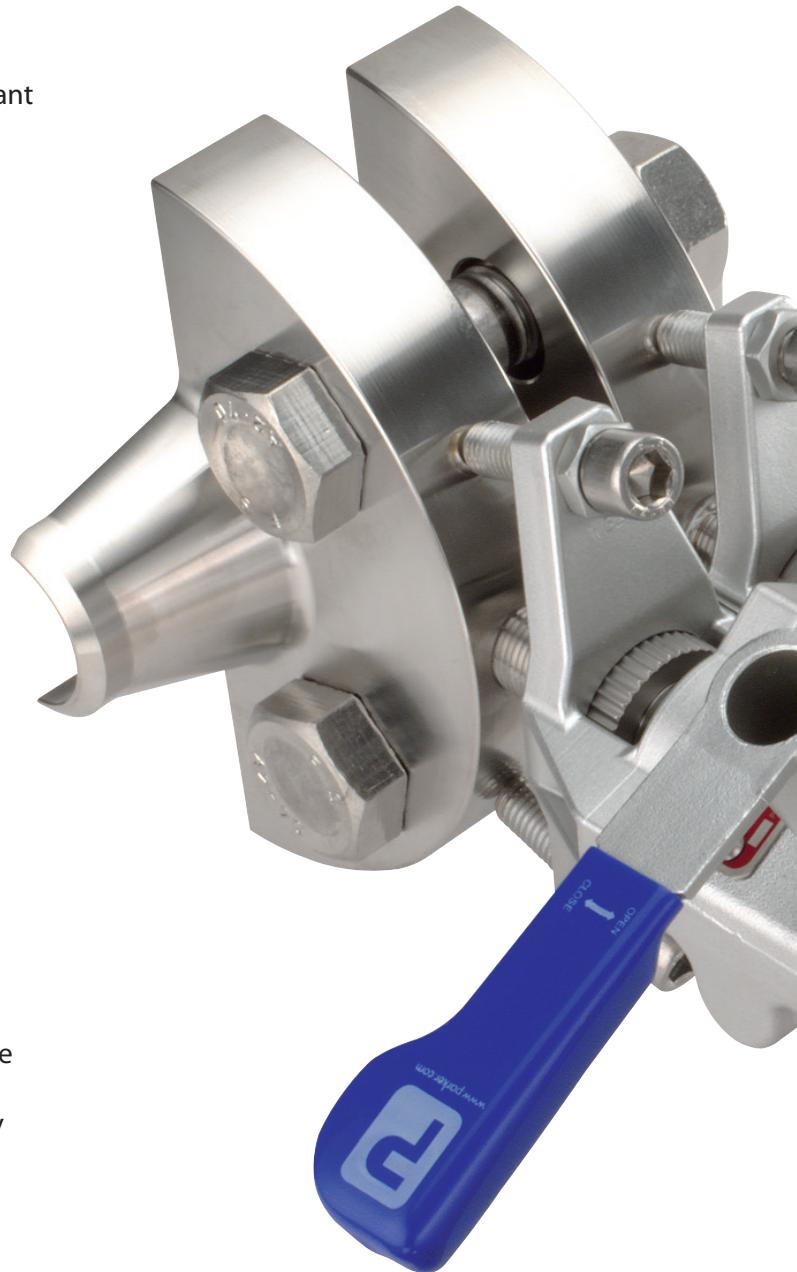

Cost of Ownership

CCIMS benefits plant operators by reducing maintenance requirements and by enhancing the integrity and performance of the instrument system.

The 5 fold decrease in instrument changeover time, the easy specification, the reduced number of purchase orders needed, the reduced spares inventory and the reduced emissions monitoring costs all contribute to the significant reduction in the total cost of ownership.

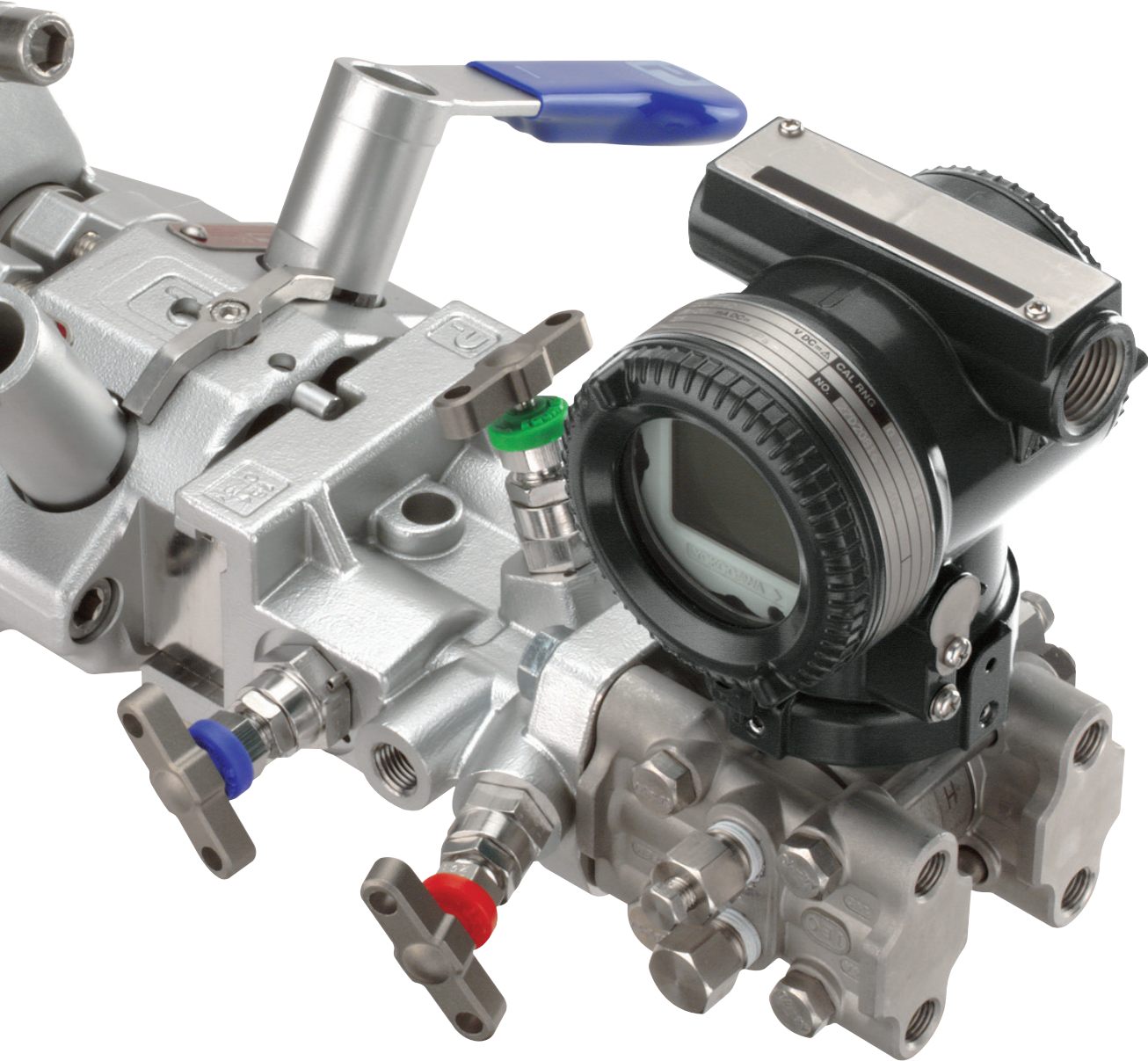

Value Proposition

Reduced Installation Costs

- CCIMS offers end users and contractors significant opportunity to reduce installations costs.
- Installation time can be reduced from a typical hook up requiring at least 12 hours, to less than 1 hour.
- The number of components required for a hook up is significantly reduced - no need for tubing, fittings, brackets, instrument stands.
- The procurement costs of dealing with multiple vendors are eliminated.

Reduced Cost of Ownership

- CCIMS delivers significant reductions in cost of ownership.
- Instrument change out time is minutes rather than hours reducing labour time and costs. Quick change out reduces any associated process downtime.
- By reducing the number of components, and being more compact than traditional hook ups. Emissions monitoring costs are reduced.
- By being closer to the process and by utilising direct flow paths gauge line errors are reduced.

Increased Safety

- CCIMS provides end users with a safer alternative to traditional hook up practice. Potential leak path and connections are reduced from more than 30 to 5.
- The unique mounting system to the orifice carrier removes any load from the process tapings removing the possibility of vibration induced fatigue failure.
- The interlocked isolation device ensures that the isolation valves cannot be opened accidentally.

Please consult your local Parker Sales Engineer or Distributor for a free evaluation of your current hook up practice together with the quantified savings that CCIMS can deliver for you.

Design & Test Data

1. Vibration

CCIMS has been tested in accordance with the standards used by the leading transmitter manufacturers for vibration requirements. CCIMS units have been subjected to a 50 hour swept sine endurance test in three axes whilst pressurised to 3,000 psi (207 bar). The test being carried out at an independent UKAS accredited testing facility.

2. Salt Spray

All components and assemblies have been subjected to a corrosive environment test in accordance with ASTM B11703 for a period of 100 hours.

3. Piping & Pressure Codes

CCIMS has been designed to, and is in accordance with the following codes:

- ASME VIII Div 1 (Design/Factor of Safety)
- ANSI/ASME B16.34 (Design/Material)
- ANSI/ASME B1.20.1 (NPT Threads)
- BS 3643 pt2 (Metric Threads)
- ANSI/ASME B16.36 (Orifice Flange connection)
- API 607/BS 6755 pt2 (Fire safety)
- IEC 61518 (Instrument connection)
- MSS-SP-25 (Product Marking)
- MSS-SP-99 (Instrument Valves)
- ASME B36.10 (MSW Pipe).

4. Environmental Testing

CCIMS units can be used with operating temperatures from -54 up to 180°C depending upon the seat material used.

Extensive thermal cycling has been conducted on the complete unit. The unit is pressurised to the maximum operating pressure for the relevant seat material, placed into a climatic chamber and thermally cycled through the full temperature range, with the pressure monitored to ensure there is no thermal fatigue failure.

5. Finite Element Analysis (FEA)

Finite Element Analysis was used throughout the design and development process to arrive at the final design.

PED/CE Marking

In accordance with Article 3 paragraph 3, of the Pressure Equipment Directive 97/23/EC, valves having a nominal size of DN25 (1 ") or less are manufactured in accordance with "Sound Engineering Practice" and it is not permitted to CE mark items which fall into this category.

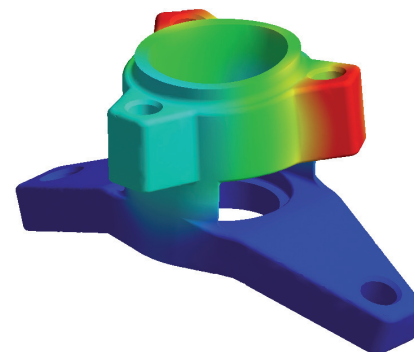
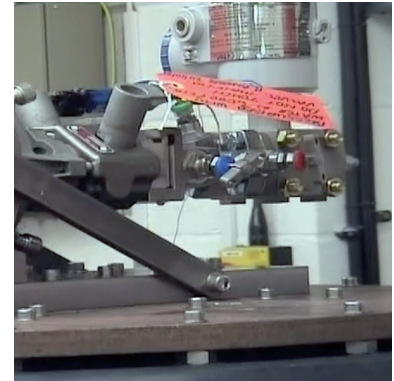

Solution Configurations

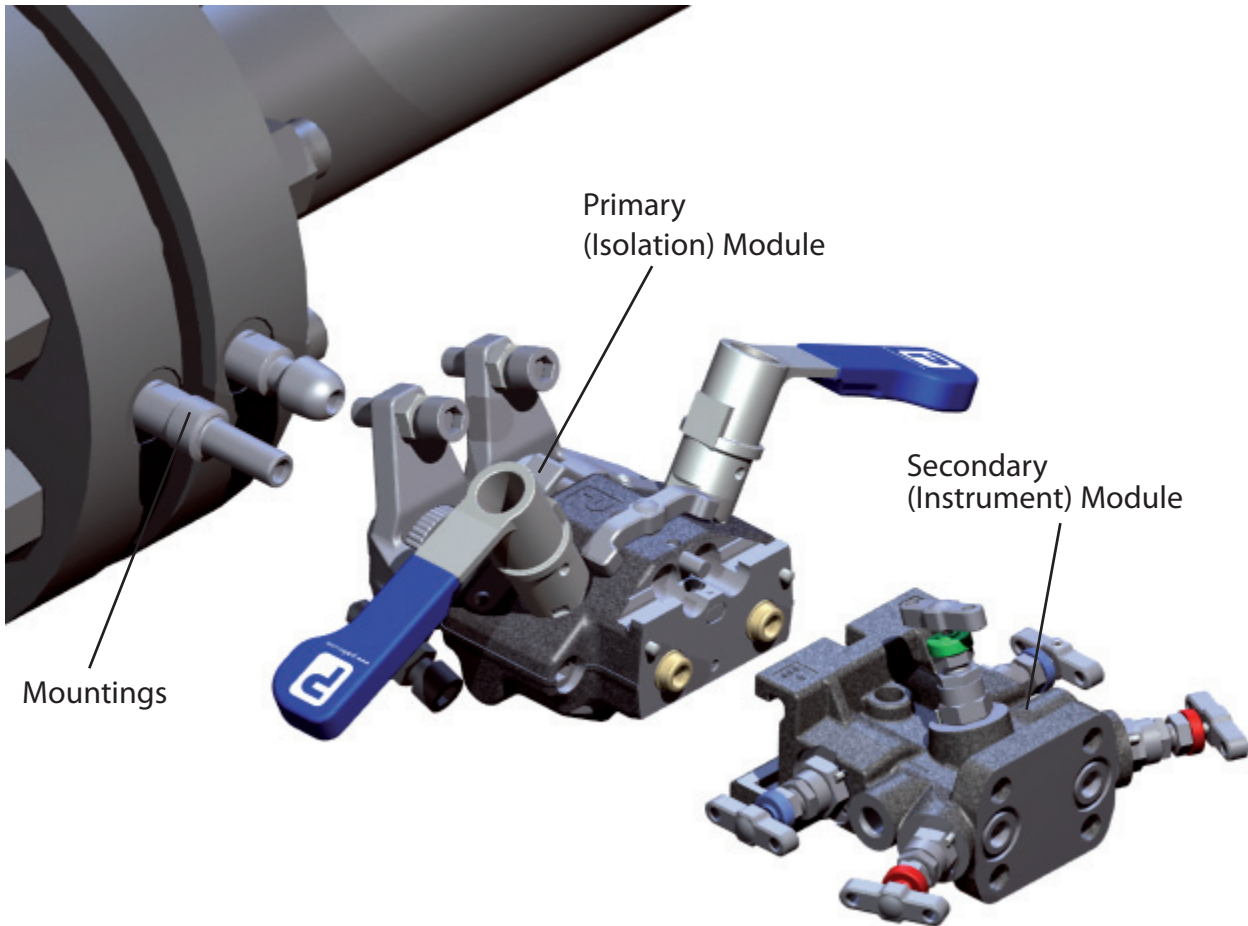

Orifice Tap Mountings

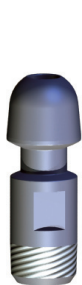

1/2 -14 NPT (Male)

Part No.

A



3/4 - 14 NPT (Male)

Part No.

B

1/2 N.B. Male Socket Weld

Part No.

C

3/4 N.B. Male Socket weld

Part No.

D

Primary (Isolation) Module Options

Singel Block

10 mm Through Bore • 1 st Isolate – Ball Pattern

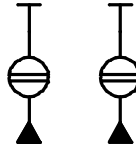
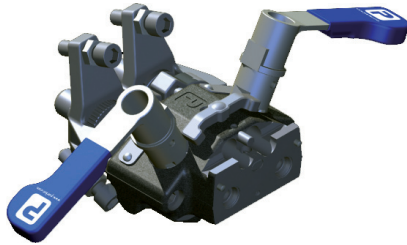

Part No.

P1

Singel Block & Bleed

10 mm Through Bore • 1 st Isolate – Ball Pattern, Bleed Valve – Needle Pattern

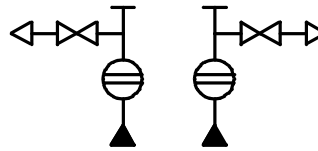
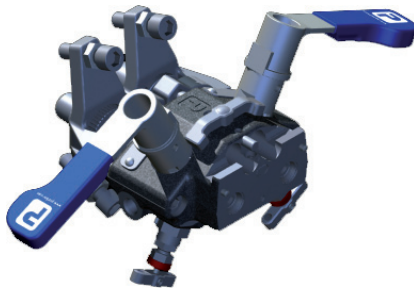

Part No.

P2

Double Block

10 mm Through Bore • 1 st Isolate – Ball Pattern • 2nd Isolate – Ball Pattern

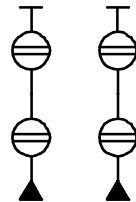
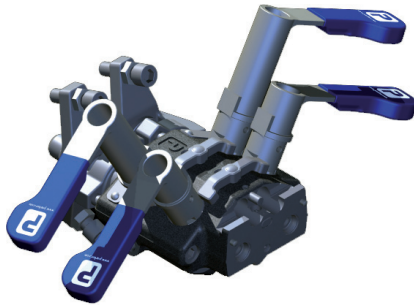

Part No.

P3

Double Block & Bleed

10 mm Through Bore • 1 st Isolate – Ball Pattern
2nd Isolate - Ball Pattern, Bleed Valve – Needle Pattern

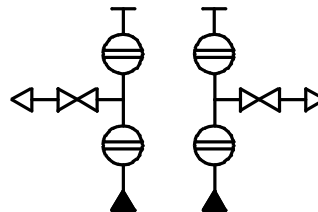
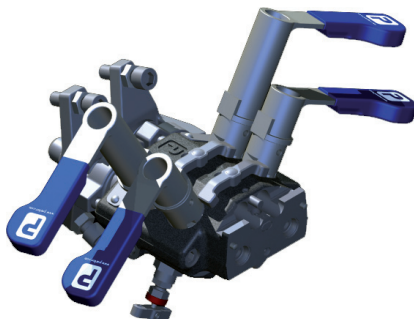

Part No.

P4

Ball Valve details - p16; Needle Valve details - p17

Primary (Isolation) Module Options

3 Valve with Rising Plug Valve (RPV) Isolate

Direct mounting to differential pressure transmitters with 54 mm/2.125" mounting centres. Designed in accordance with IEG 61518 type A (without spigot).

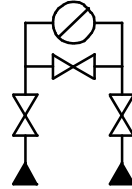
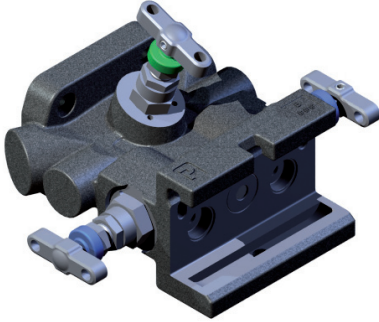

Part No.
S3R

3 Valve with Ball Valve Isolate

Direct mounting to differential pressure transmitters with 54 mm/2.125" mounting centres. Designed in accordance with IEG 61518 type A (without spigot).

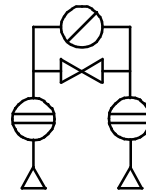
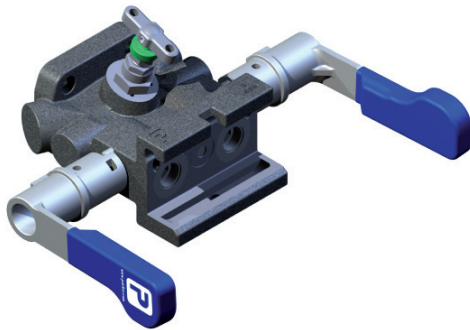

Part No.
S3B

3 Valve with Needle Valve Isolate

Direct mounting to differential pressure transmitters with 54 mm/2.125" mounting centres. Designed in accordance with IEG 61518 type A (without spigot).

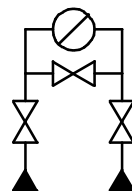
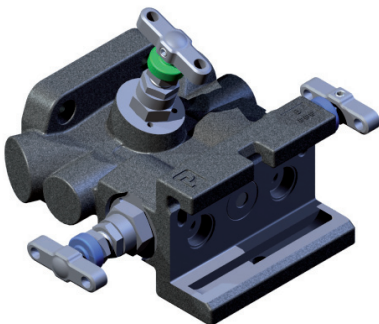

Part No.
S3N

Secondary (Instrument) Module Options: 5 Valve

5 Valve with RPV (6 mm) Isolate

Direct mounting to differential pressure transmitters with 54 mm/2.125" mounting centres.
Designed in accordance with IEG 61518 type A (without spigot).

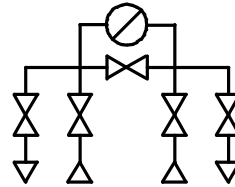
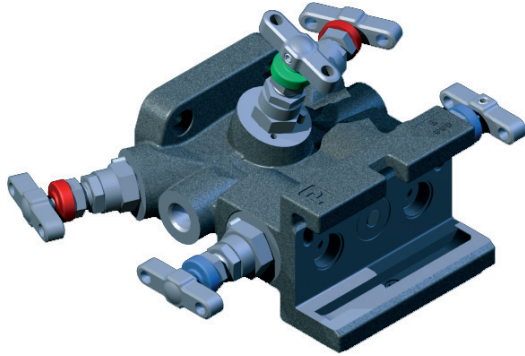

Part No.

S5R

5 Valve with Ball Valve Isolate

Direct mounting to differential pressure transmitters with 54 mm/2.125" mounting centres.
Designed in accordance with IEG 61518 type A (without spigot).

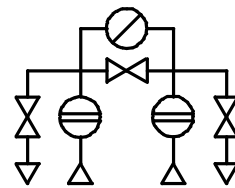
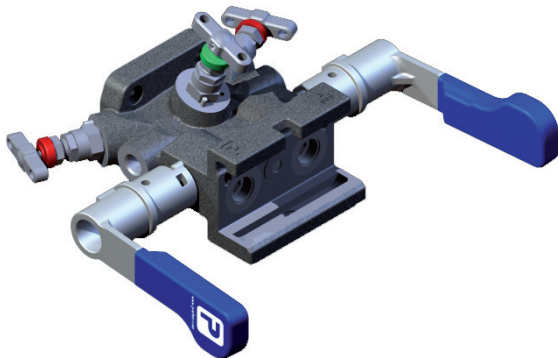

Part No.

S5B

5 Valve with Needle Valve Isolate

Direct mounting to differential pressure transmitters with 54 mm/2.125" mounting centres.
Designed in accordance with IEG 61518 type A (without spigot).

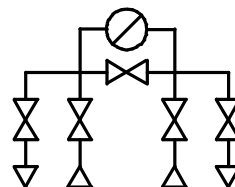
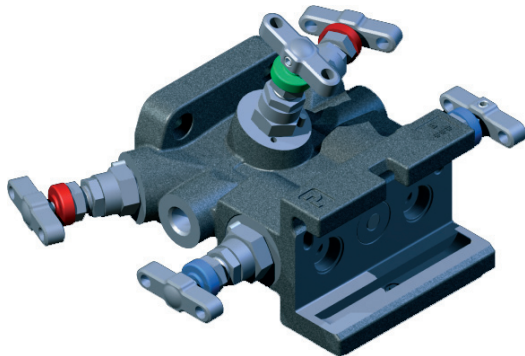

Part No.

S5N

5 Valve Custody Transfer / Fiscal Metering Module

RPV (6 mm) Isolates

Direct mounting to differential pressure transmitters with 54 mm/2.125" mounting centres. Designed in accordance with IEC 61518 type A (without spigot).

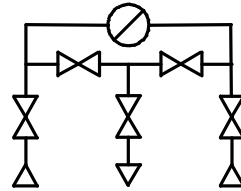
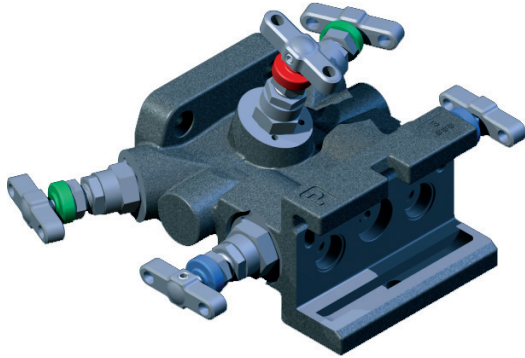

Part No.

S5R3

Ball Valve Isolates

Direct mounting to differential pressure transmitters with 54 mm/2.125" mounting centres. Designed in accordance with IEC 61518 type A (without spigot).

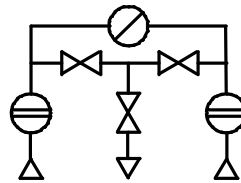
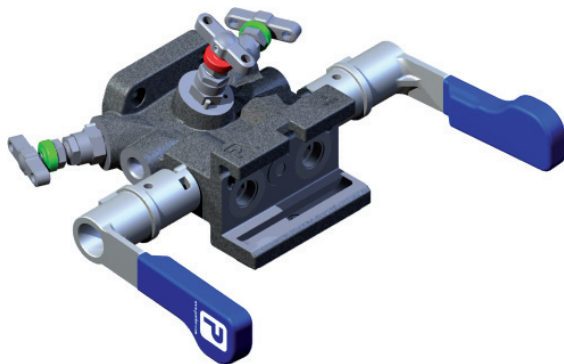

Part No.

S5B3

Needle Valve Isolates

Direct mounting to differential pressure transmitters with 54 mm/2.125" mounting centres. Designed in accordance with IEC 61518 type A (without spigot).

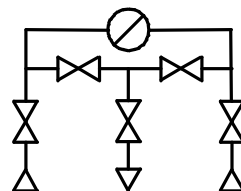
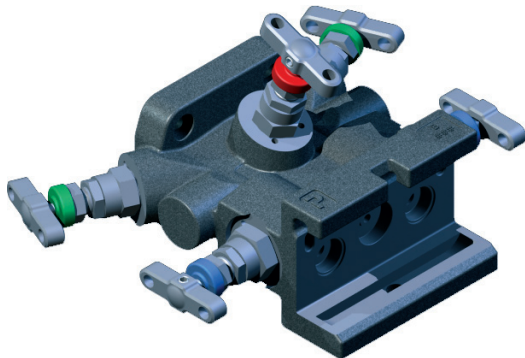

Part No.

S5N3

Auxiliary Modules & Options

Secondary Blanking Plate Module

Provides protection when instrument module is removed.

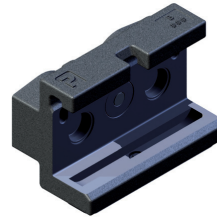

Part No.

AB

Secondary 1/2 (Female) NPT Port Connection Module

Allows use in remote mounting applications.

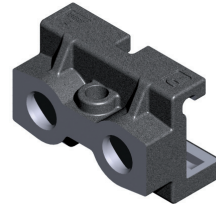

Part No.

AR

90 Degree twist Module

Used in vertical mounting installations.

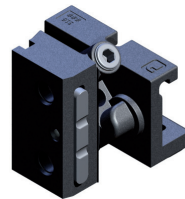

Part No.

AV

Valve Options

Lockable Primary Isolates	Anti Tamper Valves	Lockable Handwheel
<p>Part No. L</p>	<p>Part No. A</p>	<p>Part No. LHW</p>
Handwheel	Spanner Actuator	
<p>Part No. HW</p>	<p>Part No. SA</p>	

How to Order

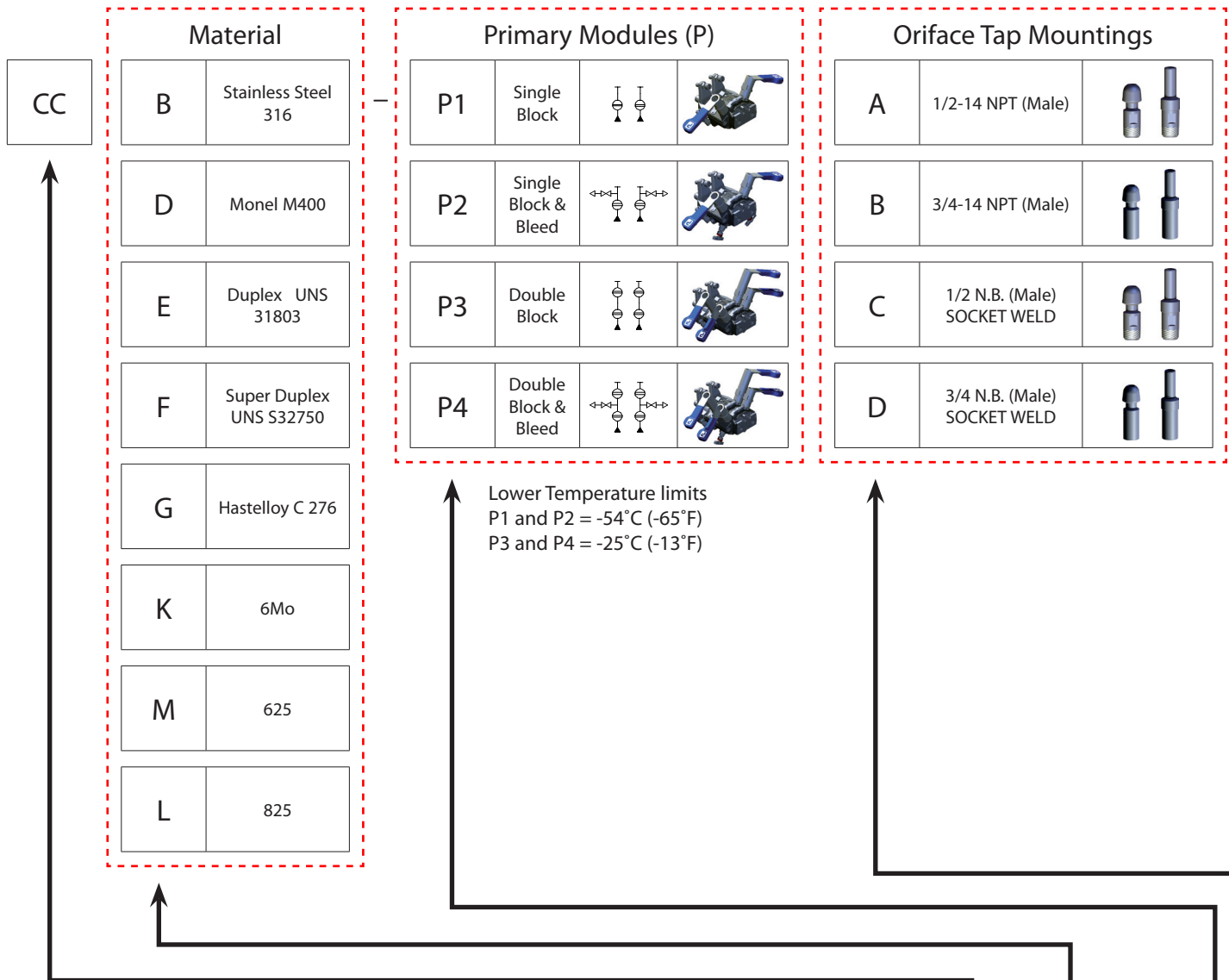





Exampel Part Number: CC B - P 1

Part Number Description:

Stainless Steel 316 - Single Block Primary Module 1/2 - 14 NPT Oriface Tap Mounting

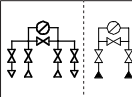
Auxiliary Secondary Modules		
AV	90° Twist Module for vertical installations	
AB	Blanking Plate	
AR	1/2 NPT (Female) Port Connection Module	

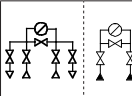
Secondary Modules (S)

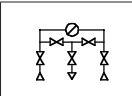
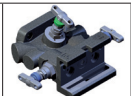
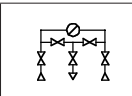
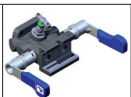
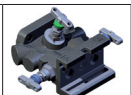
S5R	5 valve with RPV (6 mm) isolate valves.		1	Std. Flow Std. Instrument Mounting	
S5B	5 valve with ball (10 mm) isolate valves.		2	Std. Flow Coplanar Instrument Mounting	
S5N	5 valve with needle (6 mm) isolate valves.		3	Custody Transfer Flow Std. Instrument Mounting	
S5R	3 valve with RPV (6 mm) isolate valves.		4	Custody Transfer Flow Coplanar Instrument Mounting	
S3B	3 valve with ball (10 mm) isolate valves.				
S3N	3 valve with needle (6 mm) isolate valves.				

Options

A	Anti Tamper Valves	L	Lockable Primary Isolates
B	Blank Plug	N	Nace
F	Firesafe Primary module only	P	Peek Seated Ball Valves
H	HCT	SA	Spanner Actuation Primary Isolates
HW	Handwheel	3	Graphite Packing
HWL	Locking Handwheel	K	PAI PHasfit seal supplied with insertion tool

Add option suffix in alpha/numeric order. Additional options consult factory

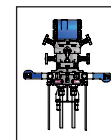

Remote Mount



Enclosure Mount

Note 1: Anti tamper and locking handle options will be fitted to vents only, unless specified otherwise.



A - S5B1 - NP

Lock Module NPT (Male) - 5 Valve Secondary Module with Ball Valve Isolates. Std Flow Std Instrument Mounting * - NACE compliant. PEEK seated ball valves **

* if not required enter XXXX

** if not required enter XX

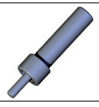
Seals & Tooling

CCIMS-ASSY-TOOL	CCIMS assembly tool. One tool supplied with every complete unit.	
PFS-INSERT-TOOL	PhastFit seal insert tool.	
PFS-SET PEEK or PFS-SET PAI	PhastFit seal set. PEEK 450G or PAI Insertion tool required for PAI, Replace seals when secondary module is.	

Valve Design & Performance Properties

CCIMS incorporates valves from our standard range of Ball, Needle and Rising Plug designs. Full details can be found in the following catalogues:

Ball Valves 4190-HBV
 Needle Valves 4190-HV
 Rising Plug Valves 4190-HV

Standard Product Specification

Supplied with PTFE seats as standard, 6000 PSIG MWP (414Barg).
 Optional PEEK seats 6000 PSIG MWP (414Barg).

Ball Valve (10mm)

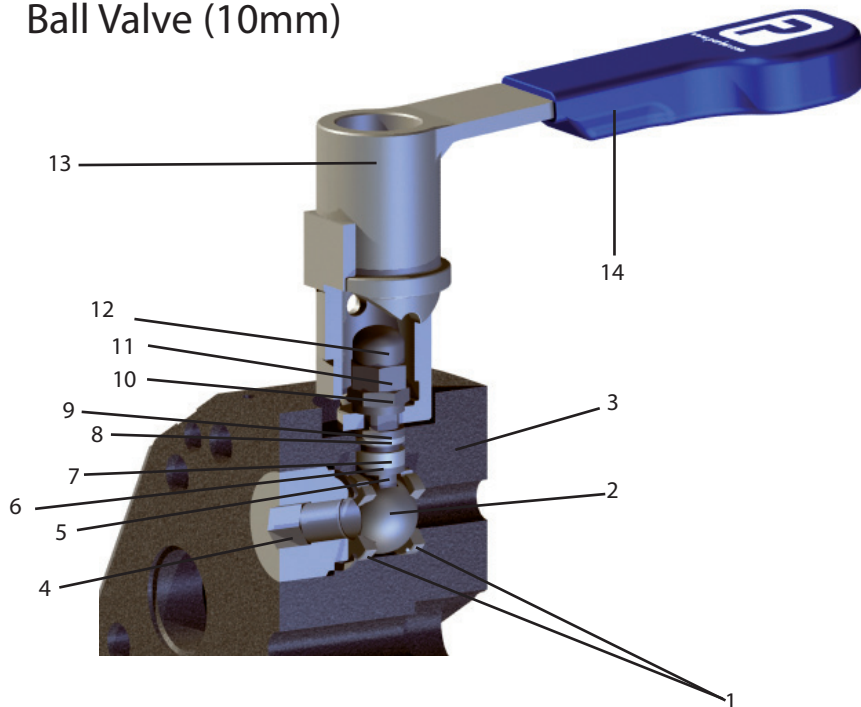

Part description

Item	Description
1	Seats
2	Ball
3	Body
4	End connector
5	Anti blowout stem
6	Thrust seal
7	Gland packing
8	Upper gland packing
9	Thrust bush
10	Thrust bush
11	Lock nut
12	Locking dome nut
13	Handle (sectioned)
14	Handle grip

Phastfit Seal

CCIMS Phastfit seal, is a unique sealing method for instrumentation. The seal facilitates the innovative method of connecting and disconnecting the secondary module in seconds. End users can quickly and easily change out the transmitter for calibration with the added value of increased calibration, accuracy, easy and reliable pressure seal connections.

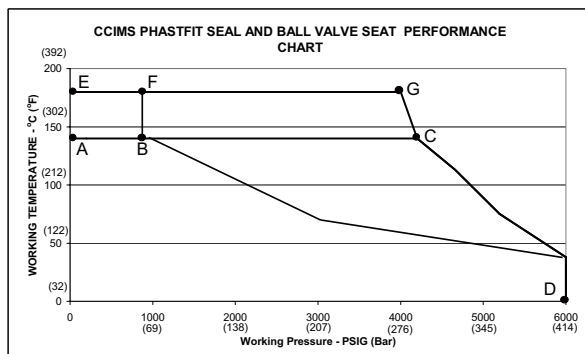
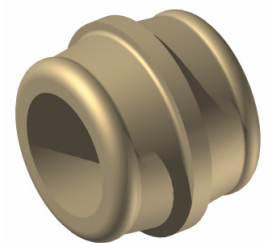

Supplied in PEEK as standard, 6000 PSIG MWP (414Barg) to 140°C (283°F), seal insertion by hand.
 Optional PAI, 6000 PSIG MWP(414Barg) to 180°C (365°F), seal insertion with PFS-INSERT TOOL (see page 15). For lower temperature limits see page 14.

Rising Plug Valve (RPV) (6mm)

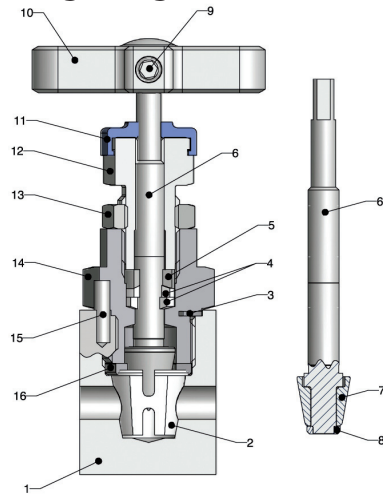

Standard Product Specification

Supplied with PEEK soft seat, PTFE packed, T bar operation 6000 psig (414 barg) max. pressure rating.

Part description

Item	Description
1	Body
2	Seat
3	Joint seal
4	Packing
5	Thrust bush
6	Stem
7	Tip
8	Stem cap
9	Grub screw
10	Handle
11	Dust cap
12	Gland adjuster
13	Lock nut
14	Bonnet
15	Pin
16	Seat retainer

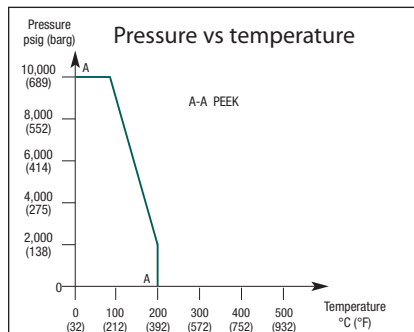

Needle Valve (6mm)

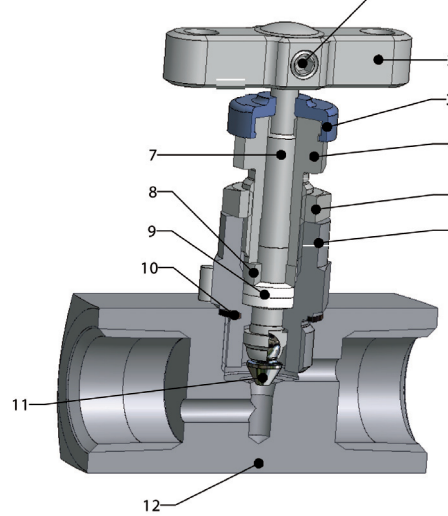

Standard Product Specification

Metal/metal seated, PTFE packed, stainless steel, T bar operation, globe pattern, 6000 psig (414 barg).

Part description

Item	Description
1	Positive handle retention
2	'T' bar
3	Dust cap
4	Gland packing adjuster
5	Gland adjuster lock nut
6	Valve bonnet
7	Anti blowout spindle
8	Thrust bush
9	Gland packing (adjustable)
10	Excess body washer
11	Spindle tip

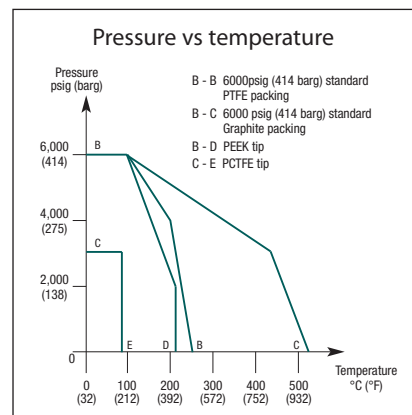

Basic Installation Guide

CCIMS – The simplest way to complete close coupled instrumentation

1.

Attach orifice tap
mountings to flanges

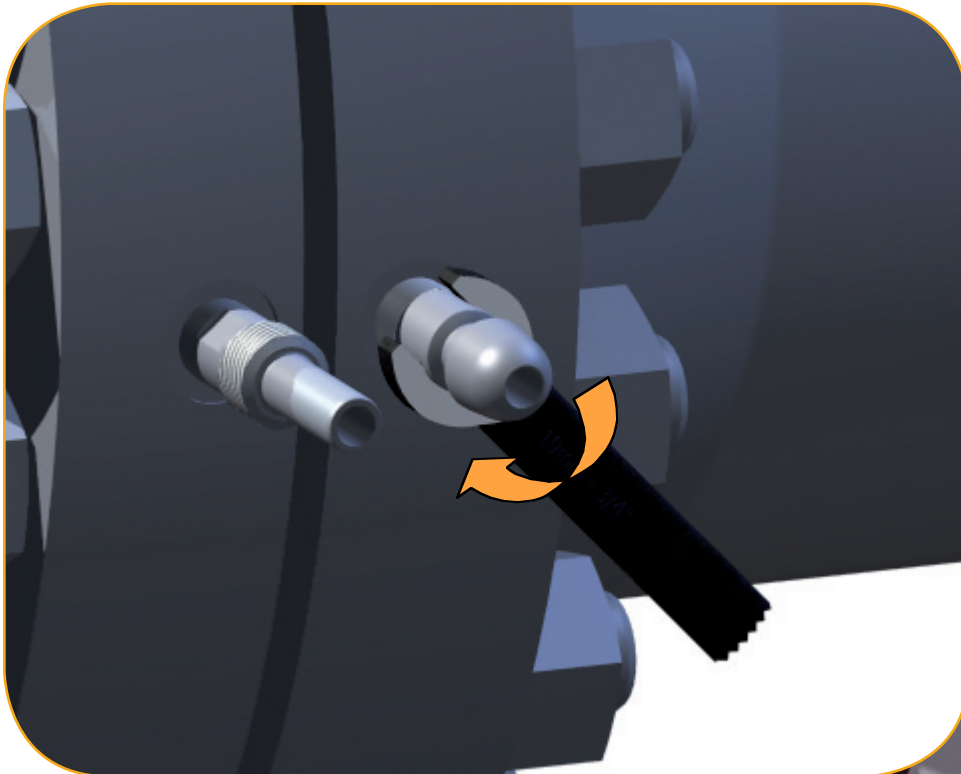

2.

Assemble primary
module to orifice
tap mountings



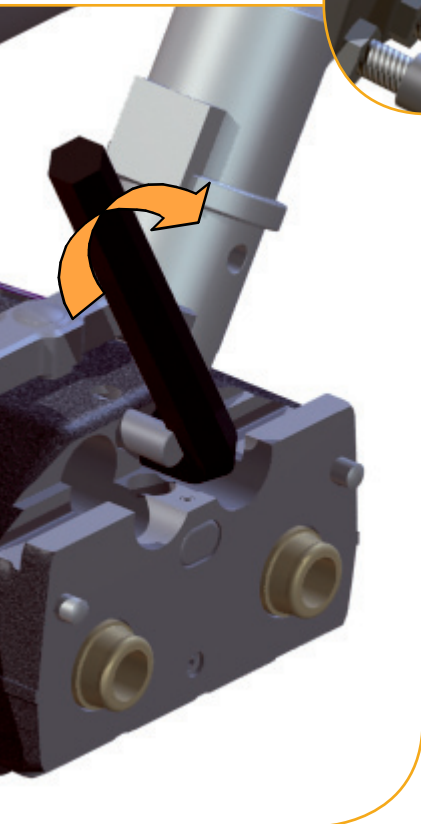
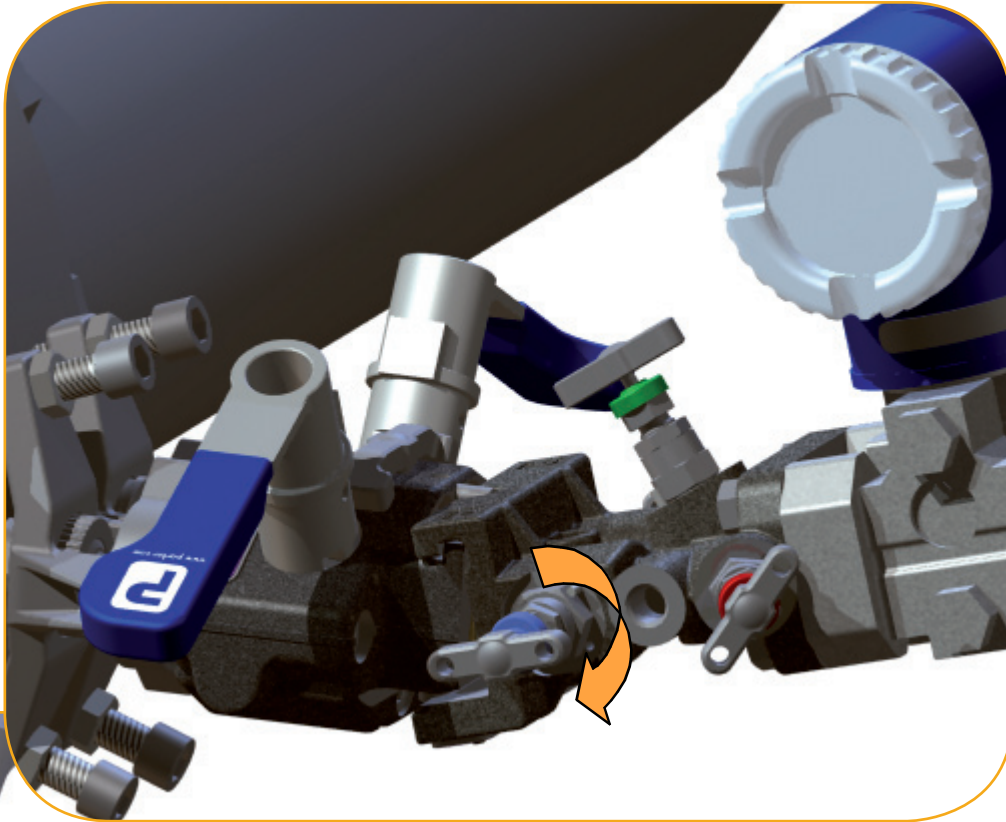

3.
Assemble secondary module
with attached instrument using
innovative Phastfit design

Detailed installation instructions are
supplied with every CCIMS unit.

Parker Worldwide

AE – UAE, Dubai

Tel: +971 4 8127100
parker.me@parker.com

AR – Argentina, Buenos Aires

Tel: +54 3327 44 4129

AT – Austria, Wiener Neustadt

Tel: +43 (0)2622 23501-0
parker.austria@parker.com

AT – Eastern Europe, Wiener Neustadt

Tel: +43 (0)2622 23501 970
parker.easteurope@parker.com

AU – Australia, Castle Hill

Tel: +61 (0)2-9634 7777

AZ – Azerbaijan, Baku

Tel: +994 50 2233 458
parker.azerbaijan@parker.com

BE/LU – Belgium, Nivelles

Tel: +32 (0)67 280 900
parker.belgium@parker.com

BR – Brazil, Cachoeirinha RS

Tel: +55 51 3470 9144

BY – Belarus, Minsk

Tel: +375 17 209 9399
parker.belarus@parker.com

CA – Canada, Milton, Ontario

Tel: +1 905 693 3000

CH – Switzerland, Etoy

Tel: +41 (0) 21 821 02 30
parker.switzerland@parker.com

CN – China, Shanghai

Tel: +86 21 5031 2525

CZ – Czech Republic, Klecany

Tel: +420 284 083 111
parker.czechrepublic@parker.com

DE – Germany, Kaarst

Tel: +49 (0)2131 4016 0
parker.germany@parker.com

DK – Denmark, Ballerup

Tel: +45 43 56 04 00
parker.denmark@parker.com

ES – Spain, Madrid

Tel: +34 902 33 00 01
parker.spain@parker.com

FI – Finland, Vantaa

Tel: +358 (0)20 753 2500
parker.finland@parker.com

FR – France, Contamine s/Arve

Tel: +33 (0)4 50 25 80 25
parker.france@parker.com

GR – Greece, Athens

Tel: +30 210 933 6450
parker.greece@parker.com

HK – Hong Kong

Tel: +852 2428 8008

HU – Hungary, Budapest

Tel: +36 1 220 4155
parker.hungary@parker.com

IE – Ireland, Dublin

Tel: +353 (0)1 466 6370
parker.ireland@parker.com

IN – India, Mumbai

Tel: +91 22 6513 7081-85

IT – Italy, Corsico (MI)

Tel: +39 02 45 19 21
parker.italy@parker.com

JP – Japan, Tokyo

Tel: +(81) 3 6408 3901

KR – South Korea, Seoul

Tel: +82 2 559 0400

KZ – Kazakhstan, Almaty

Tel: +7 7272 505 800
parker.easteurope@parker.com

LV – Latvia, Riga

Tel: +371 6 745 2601
parker.latvia@parker.com

MX – Mexico, Apodaca

Tel: +52 81 8156 6000

MY – Malaysia, Subang Jaya

Tel: +60 3 5638 1476

NL – The Netherlands, Oldenzaal

Tel: +31 (0)541 585 000
parker.nl@parker.com

NO – Norway, Ski

Tel: +47 64 91 10 00
parker.norway@parker.com

NZ – New Zealand, Mt Wellington

Tel: +64 9 574 1744

PL – Poland, Warsaw

Tel: +48 (0)22 573 24 00
parker.poland@parker.com

PT – Portugal, Leca da Palmeira

Tel: +351 22 999 7360
parker.portugal@parker.com

RO – Romania, Bucharest

Tel: +40 21 252 1382
parker.romania@parker.com

RU – Russia, Moscow

Tel: +7 495 645-2156
parker.russia@parker.com

SE – Sweden, Spånga

Tel: +46 (0)8 59 79 50 00
parker.sweden@parker.com

SG – Singapore

Tel: +65 6887 6300

SK – Slovakia, Banská Bystrica

Tel: +421 484 162 252
parker.slovakia@parker.com

SL – Slovenia, Novo Mesto

Tel: +386 7 337 6650
parker.slovenia@parker.com

TH – Thailand, Bangkok

Tel: +662 717 8140

TR – Turkey, Istanbul

Tel: +90 216 4997081
parker.turkey@parker.com

TW – Taiwan, Taipei

Tel: +886 2 2298 8987

UA – Ukraine, Kiev

Tel +380 44 494 2731
parker.ukraine@parker.com

UK – United Kingdom, Warwick

Tel: +44 (0)1926 317 878
parker.uk@parker.com

US – USA, Cleveland

Tel: +1 216 896 3000

VE – Venezuela, Caracas

Tel: +58 212 238 5422

ZA – South Africa, Kempton Park

Tel: +27 (0)11 961 0700
parker.southafrica@parker.com

European Product Information Centre

Free phone: 00 800 27 27 5374

(from AT, BE, CH, CZ, DE, EE, ES, FI, FR, IE, IT, PT, SE, SK, UK)

Ed. 2008-05-16

