

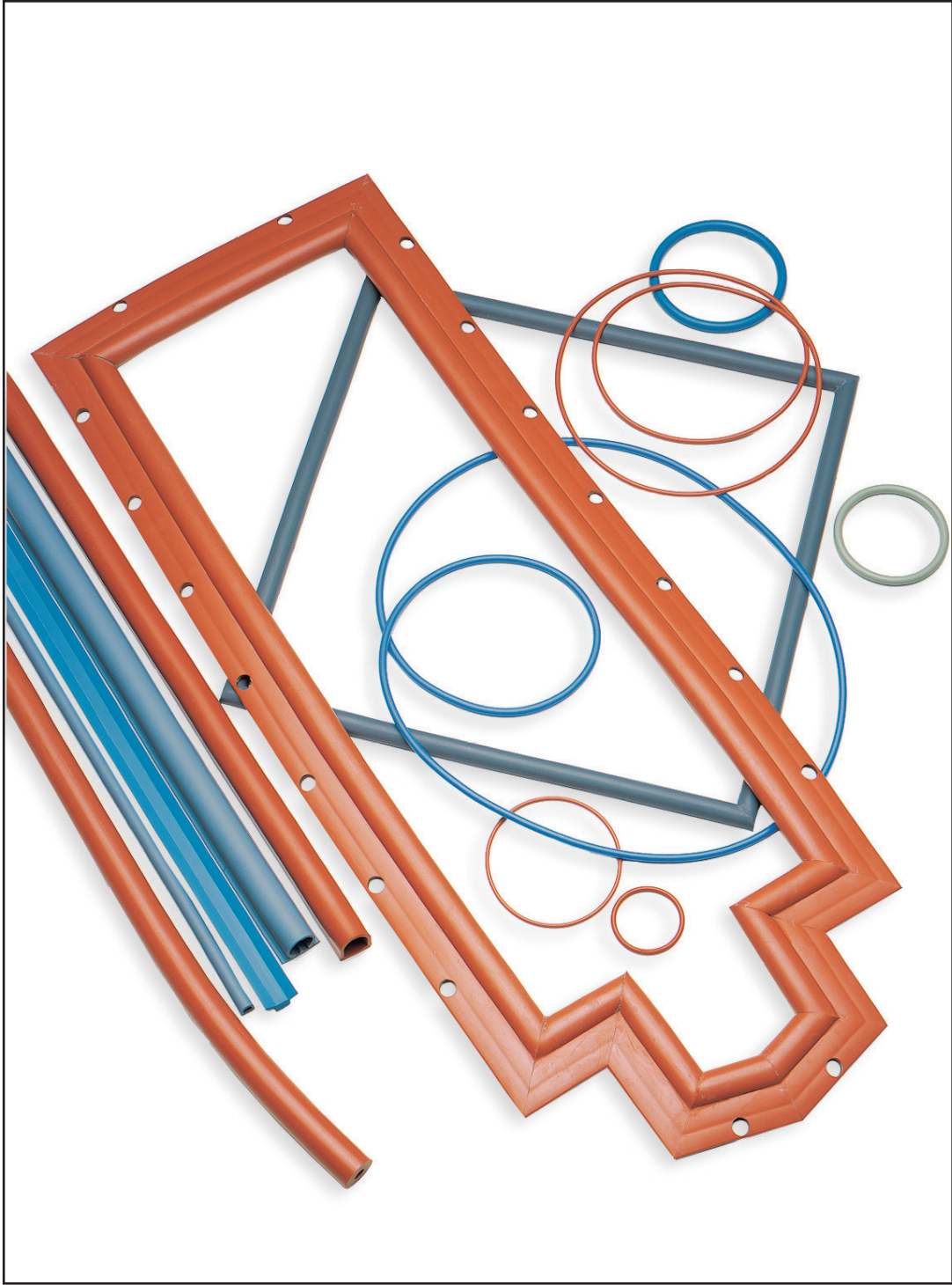

aerospace
climate control
electromechanical
filtration
fluid & gas handling
hydraulics
pneumatics
process control
sealing & shielding



ParFab™ Design Guide

Extruded and Hot Vulcanized Gaskets



TechSeal Division - TSD 5420



ENGINEERING YOUR SUCCESS.

ParFab™ Design Guide

Extruded and Hot Vulcanized Gaskets

Table of Contents

| | |
|---|-------------------|
| Overview..... | 1 |
| ParFab Product Types..... | 2 |
| Seal Attachment Options..... | 4 |
| Pressure Sensitive Adhesive (PSA)..... | 5 |
| Cross Section Design and Selection..... | 7 |
| Compression and Deflection..... | 13 |
| Value Added Services..... | 14 |
| ParFab Elastomer Options..... | 16 |
| Underwriters Laboratory (UL)..... | 21 |
| Tolerance Guide..... | 22 |
| Standard Profiles Guide..... | 23 |
| Custom Profiles Guide..... | 31 |
| How to Specify a Standard TechSeal Part Number..... | 36 |
| Appendix | |
| A. Compression / Deflection Charts..... | 37 |
| B. Physical and Chemical Characteristics of Elastomers..... | 43 |
| C. Standard Test Procedure..... | 49 |
| D. Glossary of Material Properties..... | 51 |
| Other TechSeal Products..... | Inside Back Cover |

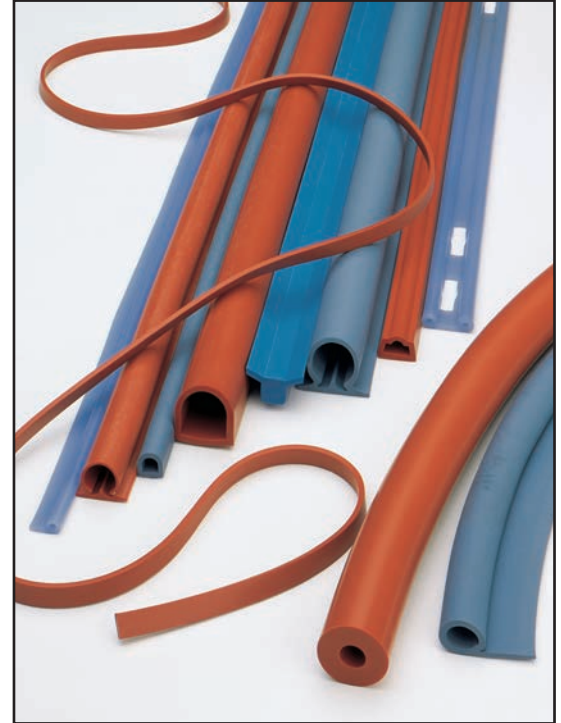

Failure, improper selection or improper use of the products and / or systems described herein or related items can cause death, personal injury or property damage.

This document and other information from Parker Hannifin Corporation, its subsidiaries and authorized distributors provides product and/or system options for further investigation by users having technical expertise. It is important that you analyze all aspects of your application and review the information concerning the product or system in the current product catalog. Due to the variety of operating conditions and applications for these products or systems, the user, through his or her own analysis and testing, is solely responsible for making the final selection of the products and systems and assuring that all performance, safety and warning requirements of the application are met.

The products described herein, including without limitation, product features, specifications, designs, availability and pricing, are subject to change by Parker Hannifin Corporation and its subsidiaries at any time without notice.

OFFER OF SALE

The items described in this document are hereby offered for sale by Parker Hannifin Corporation, its subsidiaries and its authorized distributors. This offer and its acceptance are governed by the provisions stated on page 54 of this document entitled "Offer of Sale"

ParFab is a trademark of Parker Hannifin Corporation.

ParFab Overview



Parker's TechSeal Division produces a wide range of standard and custom extruded products fabricated from a variety of sealing grade material formulations. This design guide contains a listing of standard extruded profiles used to fabricate spliced rings, gaskets or long length bulk footage on a spool or coiled for custom fabrication.

Extruded and Spliced Products

ParFab fabricated gaskets are made utilizing a hot vulcanization process to provide spliced rings and custom gaskets from either standard or custom cross-sectional profiles. The TechSeal Division's precision extruded and spliced products offer an ideal sealing solution for many applications in a broad range of markets. These products include low-closure force seals, large diameter rings, non-standard solid O-rings, and other extruded profiles with an inside diameter (I.D.) larger than 1.500" [38.1mm].

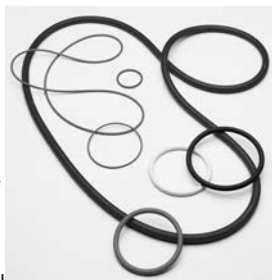

Hot Vulcanization Process

The adhesive used in the splicing process uses the same polymer as the finished product; therefore, the spliced product has high bond integrity as well as homogeneous chemical resistance. In addition, this advanced technology gives our Application Engineers tremendous flexibility in designing the optimal sealing solutions.

Long Length Extrusions

Long length extrusions are typically supplied on cardboard or plastic spools or free-coiled in lengths depending upon cross section.



Extruded Profiles Availability

The TechSeal Division offers many standard extruded profiles in solid and hollow O, solid and hollow D, U-channel, rectangular, solid and hollow square, and hollow dart configurations. These profiles are typically used for fabrication into spliced rings or custom gaskets; they can also be supplied in bulk cord. See pages 23 through 30 for a complete listing of standard profiles and groove recommendations.

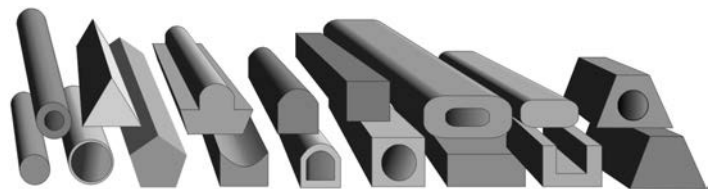

Material Availability

For the TechSeal Division's standard material offering of our most commonly used compounds, refer to page 19 or contact us for a material other than those listed. TechSeal Division offers broad range of materials for many different markets. Many of our compounds are formulated to meet or exceed specialty grade standards set by the UL, ASTM, Military, FDA, USP Class VI, NSF, and other agencies.

ParFab Product Types

DESIGN

Spliced Rings

All the TechSeal Division's spliced rings are hot vulcanized and can be provided in TechSeal's standard or customer specified cross-sectional configurations. The minimum spliced diameter is 1.500" [38.1mm] I.D.; however, this is cross-sectional dependent.

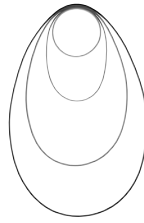

To order TechSeal's spliced rings simply choose the cross section and inform one of our Application Engineers of your preference for either the spliced I.D. or developed length. To specify a spliced ring tolerance you can either choose the I.D. or the developed length prior to splicing. Please see Table 1 below for guidelines.

| Developed Lengths [In.] | Tolerances |
|-------------------------------------|-------------------|
| D.L. ≤ 30" [762mm] | ± 0.062" [1.58mm] |
| 30" [762mm] < D.L. ≤ 50" [1270mm] | ± 0.125" [3.18mm] |
| 50" [1270mm] < D.L. ≤ 100" [2540mm] | ± 0.250" [6.35mm] |
| D.L. > 100" [2540mm] | ± 0.5% of D.L. |

Example of converting between developed length and spliced O-ring size:

A spliced ring with an I.D. of 10" [254mm] and a cross-sectional thickness of 0.250 ± 0.005" [6.35 ± 0.13mm] is required for a sealing application. What is the equivalent developed length and what tolerances can be expected?

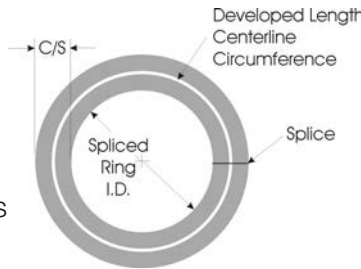

Figure 1. Developed Length

- Developed Length = (I.D. + Cross Section) × π
- Tolerance (I.D.) = Developed Length Tolerance / π + Cross Sectional Tolerance
- Developed Length = (10 + 0.250) × π = 32.201" or (254 + 6.35) × π = 817.92mm
- ⇒ Developed Length Tolerance = ± 0.125" [3.18mm] per the table 1
- Tolerance (I.D.) = 0.125 / π + 0.005 = ± 0.045" or 3.18 / π + 0.13 = ± 1.14mm

Four-Corner Spliced Gaskets (Picture Frame Gaskets)

These products are an ideal solution for flat panel (no groove) sealing and typically used for environmental sealing applications.

To specify a four-corner gasket, simply give us the outside dimensions or prepare a drawing with the selected cross section and the outside gasket dimensions (see Figure 2).

Please contact TechSeal for manufacturability if selected cross section is less than 0.100" [2.54mm]. See Table 2 for outside gasket length tolerances.

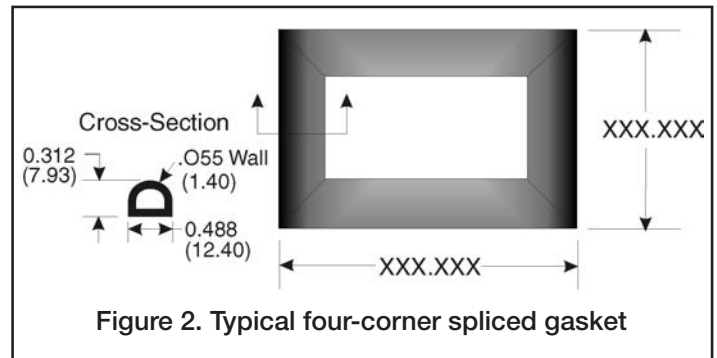

Figure 2. Typical four-corner spliced gasket

| Dimensions | Tolerances |
|-------------------|-------------------------|
| Up to 30" [762mm] | ± 0.062 [± 1.57mm] |
| Over 30" [762mm] | ± 0.4% of the dimension |

For Omega profile four-corner spliced gaskets TechSeal offers two attachment options: pressure sensitive adhesive (PSA) backing for easy attachment or mechanical fastening for more robust retention.

More information about PSA is discussed on page 5.

ParFab Product Types

Compression Limited Gaskets

Parker's compression limited ParFab gaskets are extruded and spliced seals containing ridged grommets that limit compression during assembly. The grommets are positioned to accommodate existing bolts / studs in the application and act as a "hardstop" for the mating components. These limiters prevent over-compression which often causes major damage to the integrity of the seal.

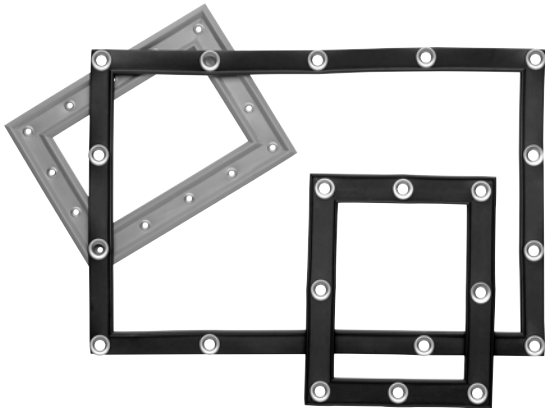

Bulk Cord

Standard and custom designed extrusions can be supplied in bulk cord, either coiled or spooled. We utilize the best commercial practices with either cardboard spools, plastic spools or free-coil packaging. Contact us for more information regarding standard sizes or special packaging requests.

Cut To Length Products

TechSeal Division's extruded products can be supplied as cut to length products from 0.030" [0.76mm] to over 1,000 feet [305m] long. Tolerances are cross section dependent. For more specific information in reference to your exact requirements please contact TechSeal.

Custom Fabricated Gaskets

The TechSeal Division can supply an almost unlimited combination of custom fabricated gaskets. Please contact our Application Engineers for design assistance and part number input. Customer approved drawings are required for non-standard parts.

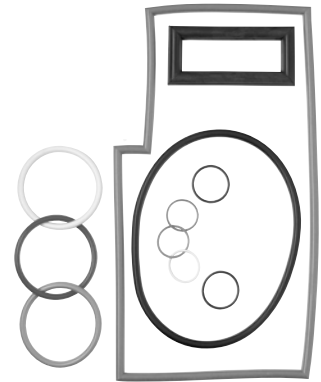

Seal Attachment Options

DESIGN

The TechSeal Division's extruded profiles can be attached to customers' hardware with several attachment options. Below are some of the common forms:

Standard O-ring Type Groove

This is a good method for capturing O-rings and other special cross-sectional shapes. The groove walls provide compression stop when the seal is properly designed metal-to-metal contact is possible.

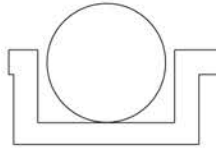

Groove for Friction-Fit Seal

This option is only possible with hollow cross sections or special custom designed profiles. It is not possible with solid-O's due to gland overfill concerns. The groove walls provide compression stop. This friction-fit seal design aides in assembly without the need for adhesive or redesigning the gland.

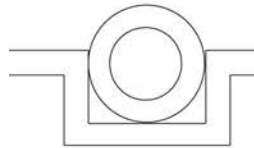

Dovetail Groove

This groove type is commonly used for molded or spliced O-rings in vacuum sealing. The dovetail groove holds the seal in place so it cannot fall out while allowing area in the corners for the seal to move under compression. These grooves are very expensive to machine, and the tolerances are especially critical; therefore, it should be used only when necessary.

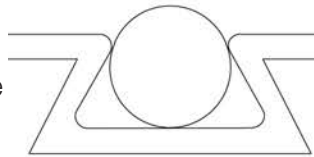

Hardware Captured

This attachment method typically does not require a groove nor adhesive to hold the seal in place. The hardware assures capture of the seal.

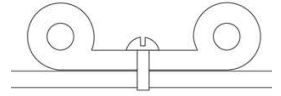

Press Fit into Notch

When properly designed the "notch" method can eliminate the need for adhesive, additional hardware, and grooves. Primarily utilized as door seals.

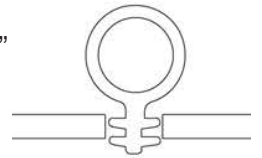

Pressure Sensitive Adhesive (PSA)

This method of attachment provides "no groove" sealing. It is a good sealing solution for low-compressive force enclosures where machined or cast grooves are not practical due to thin covers. Typically utilized as outdoor environmental seals capable of passing wind-driven rain tests.

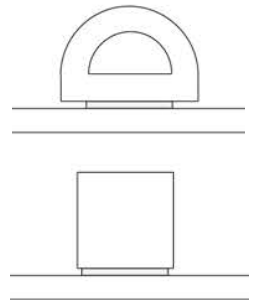

Pressure Sensitive Adhesive (PSA)

PSA backing can be applied to most extruded profiles with a flat surface such as hollow and solid D's, hollow and solid squares, rectangles, and U-channel extruded profiles. The minimum extruded cross-sectional width for PSA to be applied on is 0.125" [3.18mm]. Table 3 provides more information on PSA widths available.

TechSeal offers two types of PSA: standard temperature (ST) and high temperature (HT). Standard PSA is lower cost.

Table 3. Standard PSA Widths Available
Inch [mm]

| | |
|-------------|--------------|
| .090 [2.29] | .200 [5.08] |
| .100 [2.54] | .250 [6.35] |
| .125 [3.17] | .375 [9.52] |
| .160 [4.06] | .625 [15.87] |

TechSeal's extruded elastomers are available with a robust acrylic based PSA for permanent attachment. Typical properties for the standard temperature (ST) and high temperature (HT) adhesive are shown on the right side of this page. Peel strength data for ST adhesive is shown in Table 4.

Table 4. Typical Peel Strength

| Property | Aluminum | Steel |
|--------------------------------|----------|---------|
| Initial Peel Strength | 6.0 PPI | 6.0 PPI |
| Heat Aged Peel Strength * | 5.4 PPI | 5.4 PPI |
| Humidity Aged Peel Strength ** | 6.0 PPI | 6.0 PPI |

Peel Strength Test Data per ttt D1000 (90° peel)

*Heat aging 168 hrs / 158°F [70°C]

** Humidity aging 168 hrs / 95% RH / 158°F [70°C]

Typical Properties

Standard Temperature PSA:

PSA Description: Double-coated acrylic tape

Release Liner: Blue polypropylene plastic

Service Temperature Range: -40° to 150°F [-40° to 66°C]. PSA will function for short periods of time, for example 200 hours at 200°F [94°C]. Ultimate high temperature limit 250°F [121°C].

Shelf Life Conditions: One year at 70°F [21°C] / 50% RH

Application Temperature Range: 40° to 150°F [4° to 66°C]

High Temperature PSA:

PSA Description: High performance silicone

Release Liner: 84 lb. siliconized polycoated kraft paper

Service Temperature Range: -130° to 500°F [-90° to 260°C].

Shelf Life Conditions: One year at 70°F [21°C] / 50% RH

Application Temperature Range: 40° to 150°F [4° to 66°C]

Pressure Sensitive Adhesive (PSA)

Guidelines for Surface Preparation of Metallic Substrates

Prior to the application of PSA

It is very important to follow these instructions to ensure maximum adhesion of the PSA to the metal substrate. Failure to comply with the cleaning process could result in poor adhesion. Proper safety precautions should also be followed to protect the operator.

Materials required: 3M Scotch Brite Pads or equivalent, rubber gloves, safety glasses, lint-free cotton wipes, MEK or acetone or Isopropyl Alcohol (IPA).

Conversion-Coated Aluminum, Phosphate-Coated Steel and Plastic:

1. Using a clean, lint-free applicator, moistened with MEK, acetone solvent or IPA, wash the aluminum surface until all traces of contamination have been removed.
2. Clean the surface until the cotton applicator shows no discoloration.
3. If discoloration still exists, continue washing, changing the cotton applicator each time until clean.

Note: With phosphate coatings, it is very hard to remove all discoloration from the surface, so it is up to the operator to determine the cleanliness of the surface prior to PSA application. Typically, cleaning the surface 3 times is required.

4. Allow the substrates to dry completely at room temperature. After the cleaning sequence is complete, do not touch the substrate with bare hands prior to gasket installation.
5. If the clean surfaces do not have the PSA applied within an 8-hour period, rewash using the process described above.

Stainless Steel and Mild Steel:

1. Using a 3M Scotch Brite pad or equivalent lightly abrade the steel surface.
2. Blow the dust residue off the steel surface with oil free filtered air.
3. Follow step 1 to 5 from previous section to complete surface preparation

Gasket Installation Procedure:

1. Cut the gasket material to specific lengths if require. If gasket is one piece (e.g., four-corner spliced gasket), pre-fit the assembly to ensure fit and location.
2. Remove a portion of the release liner and position the gasket. Press firmly against gasket to tack in place. Continue pressing along the entire length of gasket until it is positioned and aligned to the mating surface.
3. Using thumb pressure or a rubber roller for ultimate adhesion, apply moderate pressure to the entire gasket to ensure complete contact between the PSA and the substrate surface.

Optimum Application Temperatures:

Temperatures below 50°F [10°C] can cause poor gasket adhesion the substrate surface during assembly. The ideal gasket installation temperature is 72°F [22°C], or room temperature.

All materials should be stored at this temperature when not in use. If hardware gasket materials are stored below 50°F [10°C] the parts should be brought to a warmer environment and allowed to come to room temperature before proceeding with the installation of the gasket assembly.

Note: It is important during this rolling procedure that the operator not apply excessive pressure to the gasket. Extreme positive pressure will cause the gasket to elongate and creep as it relaxes, which may result in a weak or intermittent bond to the substrate surface and have an effect on the seal fit.

Cross Section Design and Selection

Selection of the optimum seal cross section is a blend of the application environment, the gland geometry available, and knowledge of similar designs and concepts that have been successfully utilized in the past.

Many different profile shapes and sizes are available in standard configurations and with the design assistance available from TechSeal. Unique profiles can be developed for specific applications.

Establishing the optimal seal profile is just as important as establishing the ideal material for a given application. In fact, the combination of these two factors must be considered when designing or selecting the best seal for an application.

There are several major categories that must be taken into consideration when establishing the best seal candidate for a given application:

1. **Cross section squeeze (aka compression)**
2. **Compressive force**
3. **Installation stretch**
4. **Gland fill (aka volume-to-void ratio)**
5. **Gland groove considerations**
 - a. Flanged surfaces
 - b. Corner radius
 - c. Gland surface finish
6. **Seal material selection**
7. **Application-specific functional requirements**
 - a. Solid versus hollow cross sections
 - b. Friction fit
 - c. Wandering grooves
 - d. Venting
 - e. Twisting and parting lines
 - f. Compression and deflection

1. Cross Section Squeeze / Compression

The amount of compression or squeeze given to a seal is defined as the amount of actual deflection or displacement that occurs to the seal cross section after force is applied, and is usually referred to as a percentage of the original value. Table 5 shows the recommended deflection for several of TechSeal’s extruded elastomer profiles. The percent compression or squeeze is calculated based upon the following formula:

$$\% \text{ Squeeze} = \frac{\text{Seal C/S O.D.} - \text{Gland Depth}}{\text{Seal C/S O.D.}} \times 100$$

Table 5. Recommended Deflection

| Cross Section Geometry | Minimum Deflection | Nominal Deflection | Maximum Deflection |
|------------------------|--------------------|--------------------|--------------------|
| Solid O | 10% | 20% | 30% |
| Solid D | 10% | 20% | 30% |
| Rectangular | 8% | 15% | 25% |
| Hollow O, D & P | 15% | 30% | 50% |

For static sealing applications with solid profiles the general rule of thumb is to not exceed 30% compression, based upon the combined effects of the minimum and maximum values of the seal cross section’s O.D., the dimensions of the gland, the tolerance stack-ups of the mating parts, and the range of gland fill.

Calculations for compression or squeeze must include allowances for tolerance stack-ups of both the seal cross-section’s O.D. and the gland depth, using both the minimum and maximum values. If clearance gaps are intended to be part of the assembly, the dimensions associated with the gaps must be included in the calculations. The result is the establishment of a squeeze or compression range with calculated minimum and maximum values, using the formulas below:

Minimum Cross Section Squeeze Percent Formula:

$$\frac{\text{Seal O.D. Min} - (\text{Gland Depth Max} + \text{Clearance Gap Max})}{\text{Seal O.D. Min}} \times 100$$

Maximum Cross Section Squeeze Percent Formula:

$$\frac{\text{Seal O.D. Max} - (\text{Gland Depth Min} + \text{Clearance Gap Min})}{\text{Seal O.D. Max}} \times 100$$

Cross Section Design and Selection

DESIGN

2. Compressive Force

Compressive force or load deflection is defined as the force required to deflect a seal's cross section along each linear inch of the seal. Factors that can influence this characteristic include the physical properties of the seal material, the dimensions of the cross section, the configuration of the seal cross section (profile shape, hollow versus solid, etc.), the dimensions of the gland cross section, seal physical containment, the amount of compression and the linear compression distance.

Taking all these factors into consideration, the anticipated load becomes a range of values, and is truly application specific. It is suggested that the proper material, squeeze and gland fill parameters be defined first, then adjusted as necessary to establish the best load deflection characteristics for the application.

See Appendix A - Compression / Deflection Charts for specific force requirements based upon squeeze percentages, materials and profile configurations.

3. Installation Stretch

Installation stretch takes place when the internal perimeter (I.P.) of the spliced seal is smaller than the I.P. of the gland. This requires that the seal be stretched to fit into the groove of the assembly. Normally this is a desirable static sealing condition.

Installation stretch, usually referred to in terms of a percentage, is similar to the squeeze calculations presented earlier in that it must be established using the tolerance stack-ups of both the seal I.P. and the gland I.P. Please refer to the following formulas:

Minimum Installation Stretch Percent Formula:

$$\frac{\text{Gland I.D. Min} - \text{Seal I.D. Max}}{\text{Seal O.D. Min}} \times 100$$

Maximum Installation Stretch Percent Formula:

$$\frac{\text{Gland I.D. Max} - \text{Seal I.D. Min}}{\text{Seal O.D. Min}} \times 100$$

In many instances, it may be desirable to not have any seal stretch at all. This occurs in applications where no groove is present, or when the hollow seal's cross section has a wall (radial) thickness that may have a tendency to kink or buckle on the corners.

In order to reduce the risk of splice failure, a temporary installation stretch of thirty percent (30%) maximum is recommended. With smaller diameter seals this may become difficult depending upon the material properties and the dimensions of the cross section. The force required to stretch the seal is part specific, meaning the combined effect of the material properties, seal cross section, wall thickness and splice surface contact area can have a synergistic effect on the required stretch force. Seal recovery time should be allowed into the process when high installation stretch percentages occur.

It is also suggested that an installed I.P. stretch percentage of 0.5% to 3% be used for all traditional gland configurations. Beyond 3% the life of the seal may be reduced and excessive strain can occur at the spliced joint. Designing in a small amount of installation stretch can assist the assembly process, holding the seal in the proper position until the mating components are in place. This can also reduce the possibility of seal pinching due to the presence of excess material.

Cross Section Design and Selection

4. Gland Fill / Volume-to-Void Ratio

Gland fill is defined as the cross-sectional amount of material (volume) found in a gland cross-sectional area (void). This value is typically referred to in terms of a percentage.

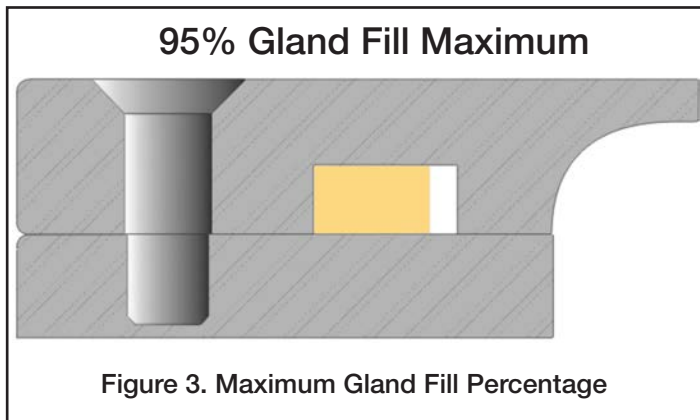

Figure 3. Maximum Gland Fill Percentage

For static applications a 95% maximum gland fill is recommended. It is extremely important that the gland fill percentage be established in terms of a range, using minimum and maximum values, which has taken into account the tolerance stack-ups of the assembly and the seal cross sections together. If a clearance gap is present in the assembly, the associated dimensions must be included in the calculations, as they were when the cross section squeeze dimensions were established.

Minimum Gland Fill Percent Formula:

$$\frac{\text{Minimum Seal Cross Section Area}}{\text{Maximum Gland Cross Section Area}} \times 100$$

Maximum Gland Fill Percent Formula:

$$\frac{\text{Maximum Seal Cross Section Area}}{\text{Minimum Gland Cross Section Area}} \times 100$$

5. Gland Groove Considerations

All elastomer materials are subject to compression set, or a loss in return force, over time. Over-compression (squeeze) can cause the polymer chains within the seal to fracture, reducing the long term sealing effectiveness.

Flange surfaces usually cannot be held perfectly flat after the bolts are tightened during assembly. As a result, the seal may become over-compressed in the areas of the bolts. Proper groove design can prevent this from happening. Use of a groove allows for metal-to-metal or plastic-to-plastic contact of the mating parts of the assembly, preventing over-compression of the seal element. A single groove is usually all that is needed.

a. Flange Surfaces:

The most frequently used profiles are O or D profiles, with either solid or hollow cross sections. Flange fasteners should be located in positions that create uniform pressure distribution at the corners and minimal clearance gaps around the component periphery. For these profiles, a high bolt torque is usually not needed to seal perfectly.

b. Corner Radius:

In order for a spliced, solid round cross section seal (O-ring) to seat properly in an application, the inner radius of the groove at the corners must be equal to or greater than the cross-sectional width of the seal. Other profiles, especially hollow ones, require a larger inside radius to prevent kinking or pinching. Typically a design allowance of 2.5 to 3 times the cross section is used for the inside corner radius.

c. Gland Surface Finish:

The surface finish of the gland is a very important part of the sealing solution. The surface should be free of nicks, burrs, scratches or dents. As illustrated in figure 4, a surface finish not to exceed 64 microinches on the gland sides and a 32 microinches on the sealing compression surfaces is typically recommended.

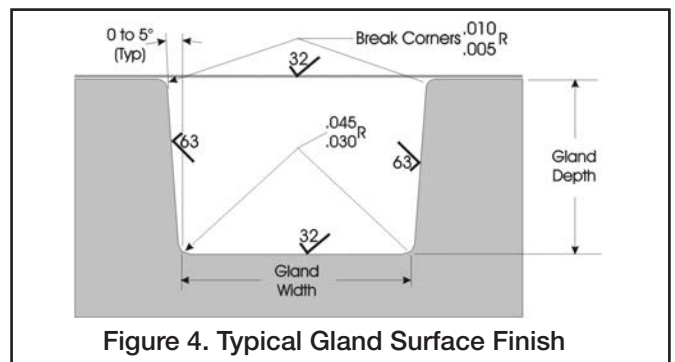

Figure 4. Typical Gland Surface Finish

Cross Section Design and Selection

DESIGN

6. Seal Material Selection

Optimizing the balance of physical properties and the environment will allow the establishment of the best sealing solution for each application. Please refer to **ParFab Elastomer Options** section (page 16 to 18) and **Appendix B** for additional information on physical and chemical properties.

7. Application Specific Functional Requirements

a. Solid versus Hollow Cross Section Profiles:

• Solid Cross Section Profiles

Various types of solid cross section seal profiles can be used to generate effective static environmental sealing results in an application. Typical standard configurations include, but are not limited to solid O, D, U, P, rectangular, and square profiles.

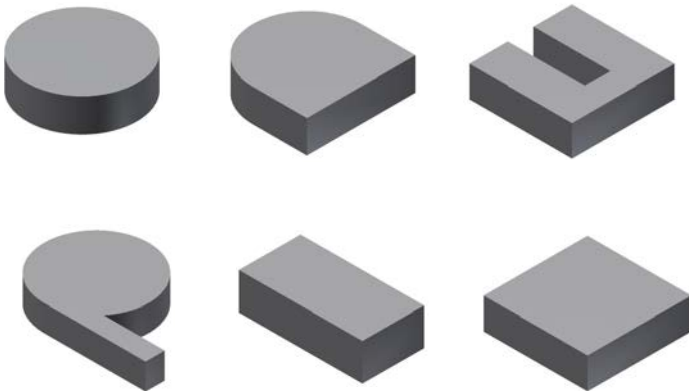

Each cross section is ideal for various different applications. Solid round cross section seals, typically termed O-rings in the sealing industry, can be deflected more easily under a given load versus square or rectangular cross section seals. Seals with flat cross sections such as rectangular or square can provide maximum sealing surface area and design flexibility.



Solid O, D, square and rectangular profiles can also be produced to fit almost any groove cross section, making seal design easier and allowing for field retrofit.

• Hollow Cross Section Profiles

The hollow seal profiles are typically used when sealing in applications that have one or more of the following characteristics:

- Clearance gaps are present after assembly.
- The gland cross section is more deep than narrow.
- Radial interference (squeeze) is needed to assist the end product assembly process.
- Low closure force is needed.
- Seal cross section surface contact area maximization without overfill.

Hollow profiles and fabricated environmental seals made from hollow profiles allow the designer to select from a vast array of seal options with almost an infinite amount of dimensional combinations. Typical configurations include hollow O, D, P, Omega, dart and square profiles.

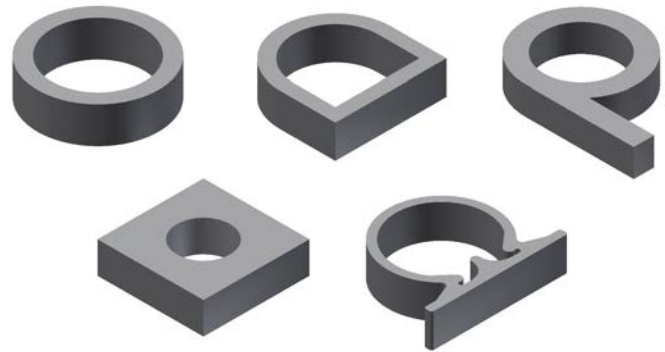

Product options, after establishing the proper cross section, include coiling or spooling in long lengths, PSA along a flat surface, splicing to create a continuous hollow ring, four-corner splicing to create a "picture frame" hollow seal and venting of the spliced seal.

Cross Section Design and Selection

b. Friction Fit:

Hollow profiles, primarily hollow O-rings, can be designed with a certain amount of radial interference into the gland. This is often desirable in applications where the seal may have a tendency to fall out prior to completion of the assembly process.

The friction fit hollow O-ring is also applicable for typical O-ring glands having a draft angle as shown in figure 4 (page 9). Please refer to page 25 in this design guide for the standard “friction fit” hollow O-ring sizes or contact the TechSeal Division for design assistance.

The cross sections of friction fit seals have been compensated to prevent gland overfill in the application. Squeeze is generated from four planes.

c. Wandering Grooves:

A wandering groove, by our definition, is a seal gland that is not perfectly square or does not have parallel sides when viewed from above. This typically occurs in applications that require the sealing element to go around bolts, bolt holes or fasteners. An example of this is shown in Figure 5.

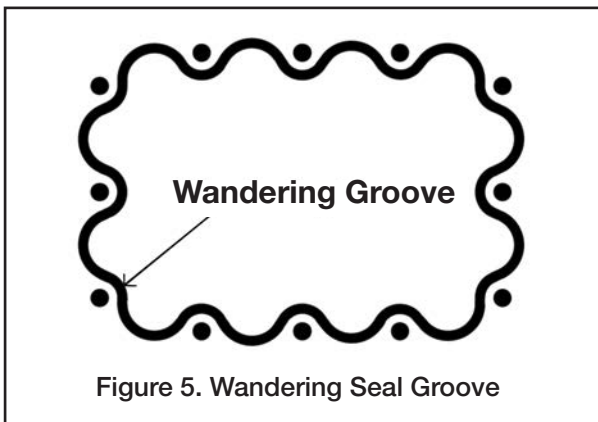

TechSeal’s extrusion and splicing capabilities provide multiple solutions for applications with wandering grooves for several reasons:

1. The seals are not molded. In many instances special molded shape seals are used in wandering groove applications. The molds are part or application specific - typically used to produce seals to solve one specific problem. If the part volume is high, multiple cavities and / or multiple molds may be required.
2. The optimal seal can be selected from TechSeal’s standard profile offering or custom designed in conjunction with our Application Engineering team. We have almost an unlimited offering of profiles and material combinations.
3. The profile can either be solid or hollow.
4. The optimum developed length and resultant spliced diameter of the seal can easily be validated in the application simply by evaluating a series of different spliced lengths in the assembly. This can not be accomplished with a molded product without a series of prototype tools.

Cross Section Design and Selection

d. Venting:

Spliced hollow profiles, when used in applications that require the periodic removal of compressive force, need to have the ability to rebound or return to their original form. When a spliced hollow profile is initially compressed, the air trapped inside the seal is also compressed.

Depending upon the elastomer material and wall (radial) seal thickness, the air may escape over a period of time. When the closure force is removed, the seal tries to recover but cannot because an internal vacuum has been created. The seal does not have the strength to draw external air back inside.



To correct this problem and to make it easier for the seal to rebound, vent holes can be built into the seal element itself. Vent holes typically located in an area that does not have a critical sealing function. This allows the seal to “breathe” when repeated opening and closing of an assembly are functional requirements.

e. Twisting and Parting Lines:

Molded products, while offering many benefits, also have inherent, process-related detriments. Some examples are parting lines, voids, mismatch (off-registration), flash, etc.

Seal twisting can cause parting lines to position against the sealing surface, potentially creating a leak path and compromising sealing integrity.

TechSeal’s process eliminates these manufacturing variables since the seal profile is extruded and cured in long lengths. Round profiles have no parting lines at all. Profiles with at least one flat surface offer stability in the gland and may also offer the option of PSA attachment.

f. Compression / Deflection:

The compression force required to squeeze any type of elastomeric seal is a very important consideration of the overall mechanical design of any application.

Solid (non-foam) elastomers are essentially incompressible materials, meaning they cannot be squeezed into a smaller volume. When a solid elastomer is subject to a compressive load, it yields by deformation of the part as a whole. Because of this behavior, the actual deflection of a gasket under a compressive load depends upon the size and shape of the gasket as well as on its modulus and the magnitude of the load.

The design of a seal should be such that its squeeze falls within the recommended percentages shown in Table 5 under Cross Section Squeeze / Compression section on page 7.

Note: For increased deflection requirements, TechSeal can provide special designed cross sections and shapes.

Cross Section Design and Selection

It is recommended that the designer perform functional testing in the specific application to ensure proper compression force exists to adequately squeeze the elastomer.

There is an approximate relationship between the force required to deflect a pure elastomer a given amount and the hardness of the elastomer. In general, the harder the elastomer, the greater the force required. Reduction in the elastomer hardness does have an impact on compressive force, but the greatest impact on reduction of closure force can be accomplished by using a Low Closure Force (LCF) cross section, which is a hollow cross-sectional extruded profile. See Figure 6 and Table 6.

To date, the most common method for reducing closure force has been to reduce the hardness (Shore) of the elastomeric seal material or change to a foam-type material. The best method to achieve a dramatic reduction in closure force is to change from a solid to a hollow cross section profile without lowering durometer hardness.

Controlling wall thickness is key to lowering the lbs / in of compressive force required. Figure 6 illustrates the dramatic effect on closure force obtained by changing the cross section of the seal element from solid to hollow.

For compression-deflection data of other profiles that are not listed in Appendix A, please contact your nearest Parker Territory Sales Manager or our Application Engineering Department.

See Appendix A for compressive load-deflection data of our most common extruded elastomer profiles and materials.

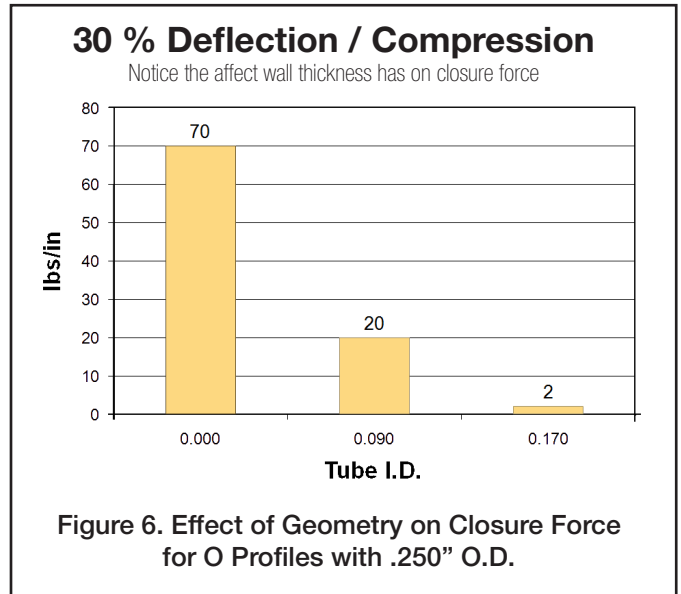

Figure 6. Effect of Geometry on Closure Force for O Profiles with .250" O.D.

Table 6. Deflection / Closure Force

Solid-O .250 O.D.

| Deflection (squeeze) | Durometer | (Shore A) |
|----------------------|--------------|-------------|
| | 40 | 70 |
| 10% | = 3.7 lb/in | 11.9 lb/in |
| 20% | = 10.3 lb/in | 33.8 lb/in |
| 30% | = 22.0 lb/in | 71.8 lb/in |
| 40% | = 43.5 lb/in | 142.0 lb/in |
| 50% | = 85.9 lb/in | 280.0 lb/in |

Hollow-O .250 O.D. x .090 I.D.

Low-Closure Profile

| Deflection (squeeze) | Durometer | (Shore A) |
|----------------------|--------------|------------|
| | 40 | 70 |
| 10% | = 1.7 lb/in | 5.6 lb/in |
| 20% | = 3.8 lb/in | 12.3 lb/in |
| 30% | = 6.0 lb/in | 19.7 lb/in |
| 40% | = 8.9 lb/in | 29.1 lb/in |
| 50% | = 28.3 lb/in | 92.4 lb/in |

Hollow-O .250 O.D. x .170 I.D.

Ultra Low-Closure Profile

| Deflection (squeeze) | Durometer | (Shore A) |
|----------------------|-------------|-----------|
| | 40 | 70 |
| 10% | = .2 lb/in | .7 lb/in |
| 20% | = .4 lb/in | 1.3 lb/in |
| 30% | = .6 lb/in | 1.8 lb/in |
| 40% | = .8 lb/in | 2.7 lb/in |
| 50% | = 1.3 lb/in | 4.1 lb/in |

TechSeal's Value Added Services

Application Engineering Support

TechSeal Division provides Application Engineering support to customers who are not familiar with the design and integration of elastomeric seals in order to ensure a successful seal design.

These engineers are able to help with:

- Material recommendations
- Cross section design
- Lathe cut size optimization
- Non-linear elastomeric Finite Element Analysis

Finite Element Analysis (FEA):

As a premier manufacturer of sophisticated sealing solutions, TechSeal Division offers its customers the dramatic time and cost saving benefits of FEA. This advanced computer simulation technology is employed to predict the behavior characteristics of different cross-sectional seal designs, bypassing the developmental trial-and-error testing of successive prototypes.

Material Characterization:

When using FEA, Parker's engineers perform a series of tests on the compound in question to obtain physical properties and characterize the material for accurate FEA results. This helps ensure the reliability of the simulation and the quality of the data acquired.

FEA will not only confirm that a proposed design will perform as expected but also allow the design to be optimized. Using complex FEA algorithms for elastomers critical design information is obtained concerning:

| | |
|----------------------------|---------------------------|
| Deformation | Stability |
| Load Deflection | Friction Force |
| Gland Fill % | Thermal Effect |
| Stress Distribution | Material Selection |

At Parker's TechSeal Division, FEA capability is fully integrated into the design process for unusual or complicated seal configurations. The result is a technically superior solution achieved more rapidly and cost effectively than ever before, allowing TechSeal and its customers to increase their speed to market.

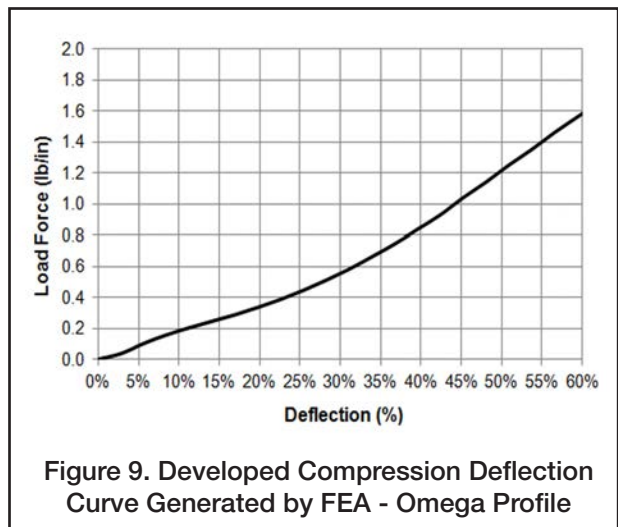
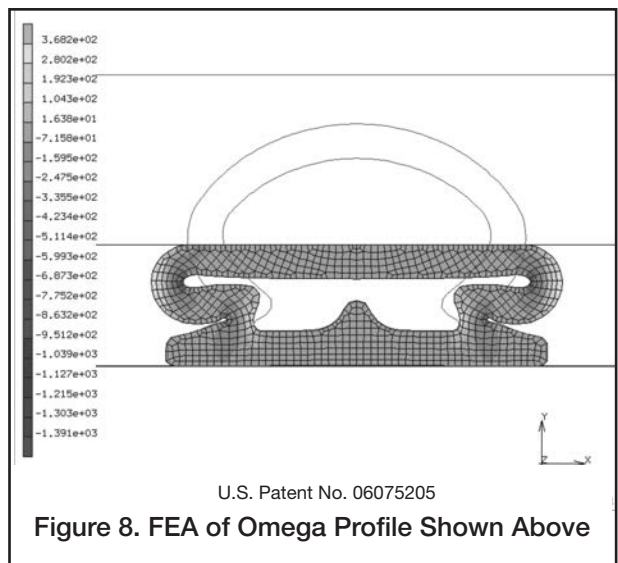
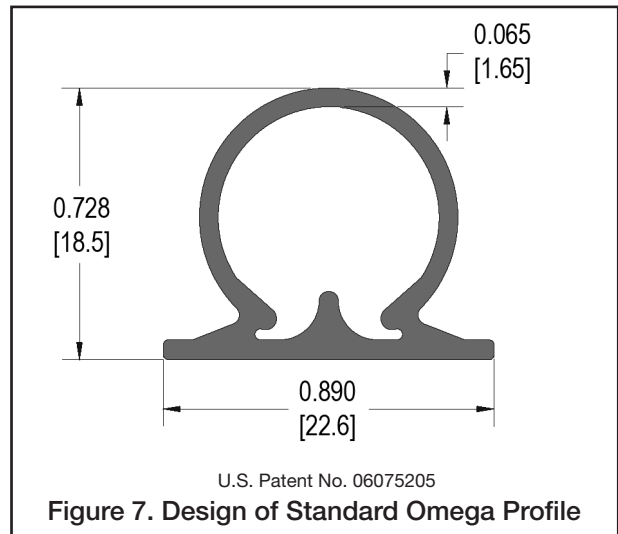

TechSeal's Value Added Services

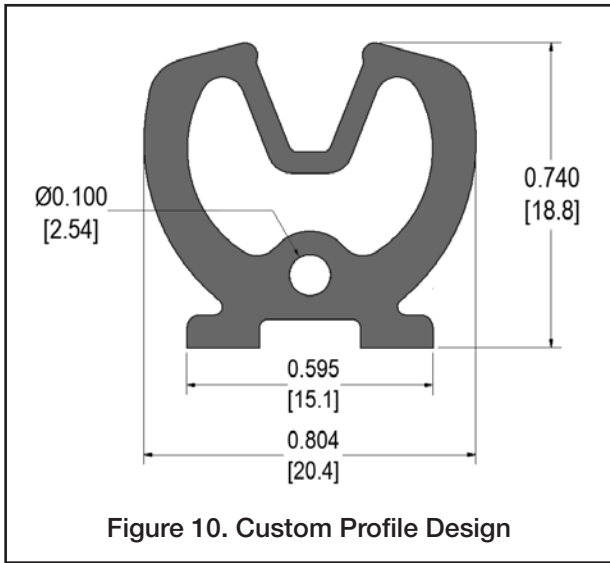

Coatings

Sometimes seals that are held under compression for long periods of time will encounter a phenomenon known as “stiction,” where the seal stubbornly sticks to the mating components around it, often pulling the seal out of the groove. To combat stiction, TechSeal Division offers the option of surface coatings, such as DuraMed™, to help reduce friction and ensure an optimal seal with extended life.

TechSeal’s DuraMed coating is more abrasion resistant and longer lasting than a PTFE coating. In addition, DuraMed is a USP Class VI material, providing an ideal seal surface coating for medical applications.

For more information, please contact TechSeal’s Application Engineering department.

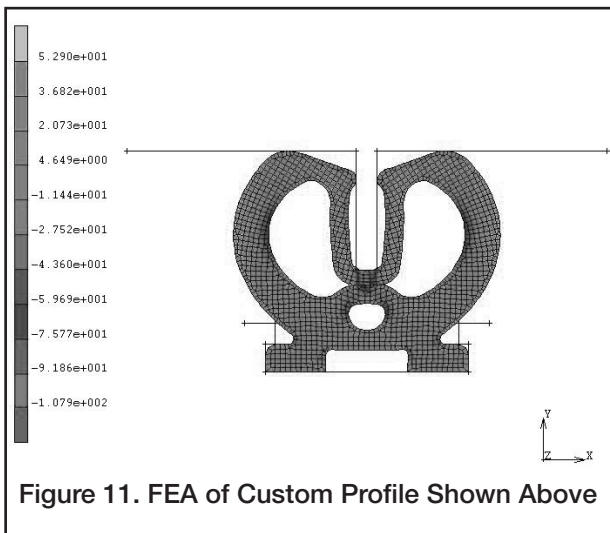

Part Printing and Marking

Customers can request several types of printing and / or marking on finished parts from TechSeal. Our current printing and marking capabilities are:

- Customer’s logo
- Parker’s logo
- Specific part number and other relevant seal information (i.e., lot number, batch number, I.D. number, date, etc.)
- Striping
- Painting / color coating

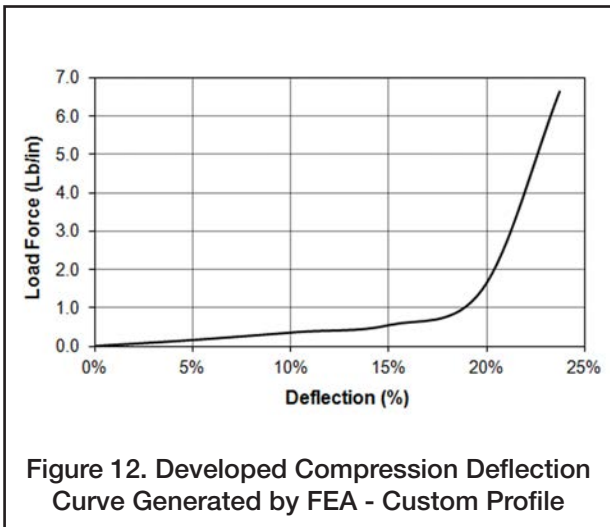

Additional Value Added Services

- Custom engineered sealing systems
- Material development
- Functional testing
- White room manufacturing
- Part cleaning and debris monitoring
- Packaging and kitting
- Worldwide distribution and service center networks

ParFab Elastomer Options

Following are brief descriptions of the most commonly used TechSeal ParFab elastomers. Consult the TechSeal Division's Application Engineers for information on our complete line of available elastomer compounds.

Acrylonitrile-Butadiene / Nitrile (NBR)

NBR is the general term for acrylonitrile butadiene terpolymer. The acrylonitrile content of nitrile sealing compounds varies considerably (18% to 50%) and influences the physical properties of the finished material.

The higher the acrylonitrile content, the better the resistance to oil and fuel. At the same time, elasticity and resistance to compression set is adversely affected. In view of these opposing realities, a compromise is often drawn and a medium acrylonitrile content selected. NBR has good mechanical properties and high wear resistance when compared with other elastomers but is not resistant to weather and ozone.

Heat resistance:

Up to 212°F [100°C] with shorter life @ 250°F [121°C]

Cold flexibility:

Depending on individual compound, between -30°F [-34°C] and -70°F [-57°C]

Chemical resistance:

- Aliphatic hydrocarbons (propane, butane, petroleum oil, mineral oil and grease, diesel fuel, fuel oils), vegetable and mineral oils and greases
- HFA, HFB and HFC fluids
- Dilute acids, alkali and salt solutions at low temperatures
- Water special compounds up to 212°F [100°C]

Not compatible with:

- Fuels of high aromatic content (for flex fuels a special compound must be used)
- Aromatic hydrocarbons (benzene)
- Chlorinated hydrocarbons (trichloroethylene)
- Polar solvents (ketone, acetone, acetic acid, ethylene-ester)
- Strong acids
- Brake fluid with glycol base
- Ozone, weather and atmospheric aging

Chloroprene / Neoprene (CR)

CR was the first synthetic rubber developed commercially and exhibits generally good ozone, aging and chemical resistance. It has good mechanical properties over a wide temperature range.

Heat resistance:

Up to approximately 250°F [121°C]

Cold flexibility:

Down to approximately -40°F [-40°C]

Chemical resistance:

- Paraffin base mineral oil with low DPI, e.g. ASTM oil No. 1
- Silicone oil and grease
- Water and water solvents at low temperatures
- Refrigerants
- Ammonia
- Carbon dioxide
- Improved ozone, weathering and aging resistance compared with NBR

Limited compatibility with:

- Naphthalene based mineral oil (IRM 902 and IRM 903 oils)
- Low molecular aliphatic hydrocarbons (propane, butane, fuel)
- Glycol based brake fluids

Not compatible with:

- Aromatic hydrocarbons (benzene)
- Chlorinated hydrocarbons (trichloroethylene)
- Polar solvents (ketones, esters, ethers, acetones)

Ethylene Propylene Rubber (EPM, EPDM)

EPDM is a copolymer of ethylene and propylene. EPDM is produced using a third monomer and is particularly useful when sealing phosphate-ester hydraulic fluids and in brake systems that use fluids having a glycol base.

ParFab Elastomer Options

Heat resistance:

Up to 250°F [121°C] (max. 400°F [204°C] in water and / or steam)

Cold flexibility:

Down to approximately -70°F [-57°C]

Chemical resistance:

- Hot water and steam up to 300°F [149°C] with special compounds up to 400°F [204°C]
- Brake fluids on glycol base up to +300°F [149°C]
- Many organic and inorganic acids
- Cleaning agents, soda and potassium alkalis
- Hydraulic fluids based on phosphate-ester (HFD-R)
- Silicone oil and grease
- Many polar solvents (alcohols, ketones, esters)
- Skydrol 500 and 7000
- Ozone, aging and weather resistant

Not compatible with:

Mineral oil products (oils, greases and fuels)

Fluorocarbon (FKM)

FKM has excellent resistance to high temperatures, ozone, oxygen, mineral oil, synthetic hydraulic fluids, fuels, aromatics, and many organic solvents and chemicals. Low temperature resistance is normally not favorable and for static applications is limited to approximately -15°F [-26°C] although in certain situations it is suitable down to -40°F [-40°C]. Under dynamic conditions, the lowest temperature expected is between 5°F and 0°F [-15°C and -18°C].

Gas permeability is very low and similar to that of butyl rubber. Special FKM compounds exhibit a higher resistance to acids, fuels, water, and steam.

Heat resistance:

Up to 400°F [204°C] and higher temperatures with shorter life expectancy.

Cold flexibility:

Down to -15°F [-26°C] some to -40°F [-40°C]

Chemical resistance:

- Mineral oil and grease, low swelling in ASTM oils No.1 through No. 3
- Non-flammable hydraulic fuels in the group HFD
- Silicone oil and grease
- Mineral and vegetable oil and grease
- Aliphatic hydrocarbons (fuel, butane, propane, natural gas)
- Aromatic hydrocarbons (benzene, toluene)
- Chlorinated hydrocarbons (trichlorethylene and carbon tetrachloride)
- Fuels, also fuels with methanol content
- High vacuum
- Very good ozone, weather and aging resistance

Not compatible with:

- Brake fluids with glycol base
- Ammonia gas, amine, alkalis
- Superheated steam
- Low molecular organic acids (formic and acetic acids)

Fluorosilicone (FVMQ)

FVMQ contains trifluoropropyl groups next to the methyl groups. The mechanical physical properties are very similar to VMQ. However, FVMQ offers improved fuel and mineral oil resistance but relatively low air resistance when compared with VMQ.

Heat resistance:

Up to 350°F [177°C] max

Cold flexibility:

Down to approximately -100°F [-73°C]

Chemical resistance:

- Aromatic mineral oils (IRM 903 oil)
- Fuels
- Low molecular weight aromatic hydrocarbons (benzene, toluene)

ParFab Elastomer Options

Hydrogenated Nitrile (HNBR)

HNBR is a synthetic polymer that results from the hydrogenation of nitrile rubber (NBR). HNBR offers superior mechanical characteristics, particularly high strength, and helps reduce extrusion and wear.

Heat resistance:

Up to approximately 300°F [150°C]

Cold flexibility:

Down to approximately -55°F [-48°C]

Chemical resistance:

- Aliphatic hydrocarbons
- Vegetable and animal fats and oils
- HFA, HFB and HFC hydraulic fluids
- Dilute acids, bases and salt solutions at moderate temperatures
- Water and steam up to 300°F [149°C]
- Ozone, aging and weathering

Not compatible with:

- Chlorinated hydrocarbons
- Polar solvents (ketones, esters and ethers)
- Strong acids

Silicone (Q, MQ, VMQ, PVMQ)

The term silicone covers a large group of materials in which vinyl-methyl-silicone (VMQ) is often the central ingredient. Silicone elastomers as a group have relatively low tensile strength, relatively low tear and wear resistance. However, they have many useful properties as well. Silicones have good heat resistance up to 450°F [232°C], good cold flexibility down to -75°F [-59°C], good ozone and weather resistance as well as good insulating and physiologically neutral properties.

Heat resistance:

Up to approximately 400°F [204°C] (special compounds up to 450°F [232°C]).

Cold flexibility:

Down to approximately -75°F to -65°F [-59°C to -54°C] with special compounds down to -175°F [-115°C].

Chemical resistance:

- Fire-resistant hydraulic fluid, HFD-R and HFD-S
- Water up to 212°F [100°C]
- Diluted salt solutions
- Ozone
- Aging
- Weather resistant

Not compatible with:

- Superheated water steam over 250°F [121°C]
- Acids and alkalis
- Animal and vegetable oil and grease
- Brake fluid (non-petroleum base)
- Low molecular weight chlorinated hydrocarbons (trichlorethylene)
- Aromatic mineral oil
- Hydrocarbon based fuels
- Aromatic hydrocarbons (benzene, toluene)

Note: While this design guide contains the most popular materials for spliced / fabricated products, TechSeal Division also has a range of other compounds with different colors, durometers, and specifications available that can be supplied as long length extrusions or fabricated products in the following polymer families: Aflas®, butyl, ethylene propylene rubber, fluorocarbon, fluorosilicone, hydrogenated nitrile, neoprene, nitrile, perfluoroelastomer and silicone with durometers ranging from 40 to 90 Shore A.

Many of TechSeal's compounds comply with special requirements including: FDA white listed ingredients, USP Class VI, UL 94 HB, UL 94V-0, UL 157, Mil-Spec/QPL, ZZ-R-765, ASTM/SAE callouts and NSF designations. Contact the TechSeal Division if you require materials other than the ones listed in this design guide.

ParFab Elastomer Options

Table 7. TechSeal’s Extrusion (Splicing and Fabrication) Standard Material Offering

| Silicone | | | | | | | | | | |
|------------------------|---------------------|-----------|-------|-------|-------|-------|-------|-------|-------|-------|
| Properties* | ASTM Test Procedure | Tolerance | S7442 | S7440 | S7395 | S7426 | S7390 | S7310 | S7416 | S7403 |
| Color | N/A | N/A | Rust | Rust | Gray | Rust | Blue | Green | Rust | Rust |
| Hardness (Shore A) | D2240 | +/- 5 | 45 | 50 | 60 | 60 | 60 | 70 | 70 | 80 |
| Tensile Strength (PSI) | D412 | Min | 1100 | 1050 | 450 | 900 | 1000 | 900 | 900 | 900 |
| Elongation (%) | D412 | Min | 325 | 400 | 300 | 250 | 200 | 150 | 200 | 100 |
| 100% Modulus, PSI | - | - | 150 | 200 | 250 | 300 | 200 | 400 | 250 | 400 |
| Compression Set (%) | D395 | Max | | | | | | | | |
| 22 hrs @ 100°C | | - | 10 | 15 | 15 | 10 | 10 | 15 | 10 | 10 |
| 70 hrs @ 150°C | | - | 25 | 20 | 50 | 20 | 20 | 60 | 25 | 30 |
| 22 hrs @ 177°C | | - | 30 | 30 | 30 | 30 | 25 | 50 | 30 | 25 |
| UL Rating** | - | - | 3 | - | 1,2,3 | 3 | - | 3 | 2 | - |

**UL Ratings: 1 = UL94 V-0 2 = UL94 HB 3 = UL157 JMLU2
See page 21 for more information on each rating.

| EPDM | | | | | | | | | |
|------------------------|---------------------|-----------|-------|-------|-------|-------|-------|-------|-------|
| Properties* | ASTM Test Procedure | Tolerance | E7110 | E7001 | E7736 | E7871 | E7972 | E7885 | |
| Color | N/A | N/A | Black | Black | Black | Black | Black | Black | Black |
| Hardness (Shore A) | D2240 | +/- 5 | 55 | 60 | 70 | 75 | 80 | 90 | |
| Tensile Strength (PSI) | D412 | Min | 1200 | 1800 | 2100 | 1900 | 1500 | 1700 | |
| Elongation (%) | D412 | Min | 400 | 350 | 200 | 200 | 125 | 100 | |
| 100% Modulus, PSI | - | - | 150 | 300 | 425 | 700 | 900 | 1000 | |
| Compression Set (%) | D395 | Max | | | | | | | |
| 22 hrs @ 70°C | | - | 15 | 20 | 15 | 15 | 10 | 30 | |
| 70 hrs @ 100°C | | - | 25 | 15 | - | 20 | 15 | 30 | |

| Nitrile | | | | |
|------------------------|---------------------|-----------|-------|-------|
| Properties* | ASTM Test Procedure | Tolerance | N7021 | N7786 |
| Color | N/A | N/A | Black | Black |
| Hardness (Shore A) | D2240 | +/- 5 | 70 | 80 |
| Tensile Strength (PSI) | D412 | Min | 1500 | 2000 |
| Elongation (%) | D412 | Min | 250 | 125 |
| 100% Modulus, PSI | - | - | 500 | 1300 |
| Compression Set (%) | D395 | Max | | |
| 22 hrs @ 100°C | | - | 25 | 35 |

| Neoprene | | | |
|------------------------|---------------------|-----------|-------|
| Properties* | ASTM Test Procedure | Tolerance | C7025 |
| Color | N/A | N/A | Black |
| Hardness (Shore A) | D2240 | +/- 5 | 80 |
| Tensile Strength (PSI) | D412 | Min | 1500 |
| Elongation (%) | D412 | Min | 150 |
| 100% Modulus, PSI | - | - | 900 |
| Compression Set (%) | D395 | Max | |
| 22 hrs @ 100°C | | - | 25 |

| Fluorocarbon | | | | |
|------------------------|---------------------|-----------|-------|-------|
| Properties* | ASTM Test Procedure | Tolerance | V7895 | V1164 |
| Color | N/A | N/A | Black | Black |
| Hardness (Shore A) | D2240 | +/- 5 | 75 | 75 |
| Tensile Strength (PSI) | D412 | Min | 1900 | 2000 |
| Elongation (%) | D412 | Min | 175 | 150 |
| 100% Modulus, PSI | - | - | 900 | 800 |
| Compression Set (%) | D395 | Max | | |
| 22 hrs @ 23°C | | - | 15 | 15 |
| 22 hrs @ 175°C | | | 15 | 15 |
| 22 hrs @ 200°C | | | 10 | 20 |

| Fluorosilicone | | | | |
|------------------------|---------------------|-----------|-------|-------|
| Properties* | ASTM Test Procedure | Tolerance | L7230 | L7332 |
| Color | N/A | N/A | Blue | Green |
| Hardness (Shore A) | D2240 | +/- 5 | 60 | 70 |
| Tensile Strength (PSI) | D412 | Min | 900 | 900 |
| Elongation (%) | D412 | Min | 175 | 175 |
| 100% Modulus, PSI | - | - | 400 | 400 |
| Compression Set (%) | D395 | Max | | |
| 22 hrs @ 100°C | | - | 10 | 15 |
| 70 hrs @ 150°C | | | 25 | 25 |
| 22 hrs @ 175°C | | | 25 | 25 |

*Unless otherwise noted, these are test values from a limited number of samples and should NOT be used for establishing specification limits.

ParFab Elastomer Options

Table 8. Typical Fluid / Media Compatibility for ParFab Applications

| Fluid/Media | Silicone | Nitrile | EPDM | Fluorocarbon | Fluorosilicone | Chloroprene |
|------------------------------------|----------|---------|------|--------------|----------------|-------------|
| Air, below 200°F [93°C] | Good | Good | Good | Good | Good | Good |
| 300°F [149°C] | Good | Fair | Fair | Good | Good | Fair |
| 400°F [204°C] | Good | Poor | Poor | Good | Fair | Poor |
| 500°F [260°C] | Good | Poor | Poor | Fair | Poor | Poor |
| ASTM Oil, No.1 | Good | Good | Poor | Good | Good | Good |
| No.2 | Poor | Good | Poor | Good | Good | Fair |
| No.3 | Poor | Good | Poor | Good | Good | Poor |
| No.4 | Poor | Fair | Poor | Good | Fair | Poor |
| Automatic Transmission Fluid | Poor | Good | Poor | Good | Good | Fair |
| Carbon Dioxide | Good | Good | Good | Good | Good | Good |
| Corn Oil | Good | Good | Fair | Good | Good | Poor |
| Hydraulic Fluids (Organic) | Fair | Good | Poor | Good | Good | Fair |
| Hydraulic Fluids (Phosphate Ester) | Poor | Poor | Good | Fair | Good | Fair |
| Hydrocarbon Fuels (Saturated) | Poor | Good | Poor | Good | Good | Fair |
| Ozone | Good | Poor | Good | Good | Good | Fair |

Note that all recommended compounds are suggestions only. Customers should always test any seal material under actual operating conditions. More detailed fluid media compatibility information may be obtained by contacting the Parker TechSeal Division.

Underwriters Laboratory (UL)

The Underwriters Laboratory (UL) provides a testing and qualification service to quantify certain properties of silicone elastomer materials. The basic test criteria used by UL in testing TechSeal's silicone compounds are shown below:

UL94 V-0

Defined as the vertical burn rate in millimeters per minute of a material with a thickness less than 0.031" [0.79mm]. Parker TechSeal Division's compound S7395-60 will cease to burn after the ignition source is removed, will not glow under UL test conditions and will not have flaming particles or drops.

UL94 HB

The calculation of the linear burn rate in millimeters per minute. S7395-60, S7416-70 and 7310-70 do not have burn rates which exceed 75mm per minute for a thickness less than 0.059" [1.4mm] for S7416-70 and S7310-70 and 0.011"[0.27mm] for S7395-60.

UL157 JMLU2

Parker TechSeal Division's compounds S7395-60, S7426-60 and S7442-40 are UL157 JMLU2 listed and meet the UL requirements for tensile, durometer, elongation, all for original physical properties, and after heat aging. Additionally, UL listed materials must pass low-temperature brittleness, compression set and ozone exposure testing.

Table 9. Underwriters Laboratory (UL) Listed TechSeal Division Silicone Materials

| | S7442-40 | S7395-60* | S7426-60** | S7310-70 | S7416-70 |
|-----------------------------|---------------|--------------------|---------------|--------------------|--------------------|
| UL94 V-0 | | X .055" [1.4mm] | | | |
| UL94 HB | | X .011" [.27mm] | | X .059" [1.5mm] | X .059" [1.5mm] |
| UL157 JMLU2 | X | X | X | | |
| UL50 | | X | | | |
| Low Temperature Brittleness | -67°F [-55°C] | -85°F [-65°C] | -67°F [-55°C] | -67°F [-55°C] | -65°F [-55°C] |

*UL listed as S7395U-60

**UL listed as S7426U-60

The numbers in each box above are the minimum wall thicknesses approved by UL



Tolerance Guide

PROFILES

Table 10. Extrusion Manufacturing Cross-Sectional Tolerance Guidelines

| Cross Section O.D. Range | .040 - .125 in [1.02 - 3.18 mm] | | .126 - .190 in [3.20 - 4.83 mm] | | .191 - .250 in [4.85 - 6.35 mm] | | .251 - .300 in [6.38 - 7.62 mm] | | .301 - .375 in [7.65 - 9.53 mm] | | .376 - .500 in [9.55 - 12.70 mm] | | .501 - .750 in [12.73 - 19.05 mm] | | .751 - 1.000 in [19.08 - 25.40 mm] | | |
|--------------------------|------------------------------------|-------|------------------------------------|-------|------------------------------------|-------|------------------------------------|-------|------------------------------------|-------|-------------------------------------|-------|--------------------------------------|-------|---------------------------------------|-------|-------|
| | in | mm | in | mm | in | mm | in | mm | in | mm | in | mm | in | mm | in | mm | |
| VMQ | | 0.003 | 0.004 | 0.005 | 0.006 | 0.007 | 0.008 | 0.009 | 0.010 | 0.012 | 0.015 | 0.015 | 0.015 | 0.015 | 0.015 | 0.015 | 0.015 |
| | | 0.08 | 0.10 | 0.13 | 0.15 | 0.18 | 0.20 | 0.23 | 0.25 | 0.30 | 0.38 | 0.38 | 0.38 | 0.38 | 0.38 | 0.38 | 0.38 |
| FVMQ | | 0.005 | 0.006 | 0.007 | 0.008 | 0.009 | 0.010 | 0.012 | 0.015 | 0.015 | 0.015 | 0.015 | 0.015 | 0.015 | 0.015 | 0.015 | 0.015 |
| | | 0.13 | 0.15 | 0.18 | 0.20 | 0.23 | 0.25 | 0.23 | 0.25 | 0.23 | 0.25 | 0.25 | 0.23 | 0.25 | 0.23 | 0.25 | 0.25 |

VMQ: Silicone
FVMQ: Fluorosilicone

| Cross Section O.D. Range | .040 - .125 in [1.02 - 3.18 mm] | | .126 - .210 in [3.20 - 5.33 mm] | | .211 - .275 in [5.36 - 6.99 mm] | | .276 - .437 in [7.01 - 11.10 mm] | | .438 - .625 in [11.13 - 15.88 mm] | | .626 - .750 in [15.90 - 19.05 mm] | |
|--------------------------|------------------------------------|-------|------------------------------------|-------|------------------------------------|-------|-------------------------------------|-------|--------------------------------------|-------|--------------------------------------|-------|
| | in | mm | in | mm | in | mm | in | mm | in | mm | in | mm |
| EPDM | | 0.005 | 0.005 | 0.007 | 0.007 | 0.008 | 0.008 | 0.009 | 0.009 | 0.010 | 0.012 | 0.015 |
| | | 0.13 | 0.13 | 0.18 | 0.25 | 0.30 | 0.38 | 0.30 | 0.38 | 0.30 | 0.38 | 0.38 |
| NBR | | 0.005 | 0.005 | 0.007 | 0.007 | 0.008 | 0.008 | 0.009 | 0.009 | 0.010 | 0.010 | 0.010 |
| | | 0.13 | 0.13 | 0.18 | 0.20 | 0.20 | 0.25 | 0.23 | 0.23 | 0.25 | 0.25 | 0.25 |
| HNBR | | 0.005 | 0.005 | 0.007 | 0.007 | 0.008 | 0.008 | 0.009 | 0.009 | 0.010 | 0.010 | 0.010 |
| | | 0.13 | 0.13 | 0.18 | 0.20 | 0.20 | 0.25 | 0.23 | 0.23 | 0.25 | 0.25 | 0.25 |
| CR | | 0.005 | 0.005 | 0.007 | 0.007 | 0.008 | 0.008 | 0.009 | 0.009 | 0.010 | 0.010 | 0.010 |
| | | 0.13 | 0.13 | 0.18 | 0.20 | 0.20 | 0.25 | 0.23 | 0.23 | 0.25 | 0.25 | 0.25 |

EPDM: Ethylene Propylene Rubber
NBR: Nitrile
HNBR: Hydrogenated Nitrile
CR: Neoprene

| Cross Section O.D. Range | .040 - .080 in [1.02 - 2.00 mm] | | .081 - .118 in [2.06 - 3.00 mm] | | .119 - .157 in [3.02 - 3.98 mm] | | .158 - .210 in [4.01 - 5.33 mm] | | .211 - .295 in [5.36 - 7.50 mm] | | .296 - .335 in [7.52 - 8.50 mm] | | .336 - .437 in [8.53 - 11.10 mm] | | .438 - .500 in [11.13 - 12.70 mm] | |
|--------------------------|------------------------------------|-------|------------------------------------|-------|------------------------------------|-------|------------------------------------|-------|------------------------------------|-------|------------------------------------|-------|-------------------------------------|-------|--------------------------------------|-------|
| | in | mm | in | mm | in | mm | in | mm | in | mm | in | mm | in | mm | in | mm |
| FKM | | 0.004 | 0.005 | 0.006 | 0.006 | 0.008 | 0.008 | 0.010 | 0.010 | 0.012 | 0.012 | 0.012 | 0.014 | 0.014 | 0.018 | 0.018 |
| | | 0.10 | 0.12 | 0.15 | 0.20 | 0.20 | 0.25 | 0.25 | 0.25 | 0.30 | 0.30 | 0.30 | 0.36 | 0.36 | 0.46 | 0.46 |

FKM: Fluorocarbon

***NOTE:** These tables are general guidelines based on standard materials, configurations and manufacturing processes. Please consult TechSeal's Application Engineering department for guidance related to tolerance of special profiles or precision tolerance requirements.

****NOTE:** Tolerance information for other material families are also available. Please contact the TechSeal Division for more details.

Standard Profiles Guide - Solid-O

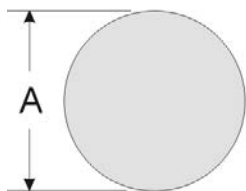

Table 11. Solid O - TechSeal Configuration “A” Designation

Please refer to page 36 for how to specify a standard TechSeal part number.

| TechSeal Profile Part Number | A - Nominal Outside Diameter | | Groove Depth | | | | Groove Width Vacuum & Gases | | | | Groove Width Liquids | | | |
|------------------------------|------------------------------|-------|--------------|-------|--------|-------|-----------------------------|-------|--------|-------|----------------------|-------|--------|-------|
| | | | Min | | Max | | Min | | Max | | Min | | Max | |
| | inches | mm | inches | mm | inches | mm | inches | mm | inches | mm | inches | mm | inches | mm |
| A001XXXXXX | 0.040 | 1.02 | 0.029 | 0.74 | 0.031 | 0.79 | 0.053 | 1.35 | 0.058 | 1.47 | 0.059 | 1.50 | 0.065 | 1.65 |
| A002XXXXXX | 0.048 | 1.22 | 0.034 | 0.86 | 0.037 | 0.94 | 0.062 | 1.57 | 0.067 | 1.70 | 0.070 | 1.78 | 0.076 | 1.93 |
| A003XXXXXX | 0.050 | 1.27 | 0.036 | 0.91 | 0.039 | 0.99 | 0.065 | 1.65 | 0.070 | 1.78 | 0.072 | 1.83 | 0.078 | 1.98 |
| A004XXXXXX | 0.053 | 1.35 | 0.038 | 0.97 | 0.041 | 1.04 | 0.068 | 1.73 | 0.073 | 1.85 | 0.076 | 1.93 | 0.082 | 2.08 |
| A005XXXXXX | 0.060 | 1.52 | 0.043 | 1.09 | 0.046 | 1.17 | 0.076 | 1.93 | 0.081 | 2.06 | 0.085 | 2.16 | 0.091 | 2.31 |
| A006XXXXXX | 0.062 | 1.57 | 0.045 | 1.14 | 0.048 | 1.22 | 0.078 | 1.98 | 0.083 | 2.11 | 0.088 | 2.24 | 0.094 | 2.39 |
| A007XXXXXX | 0.070 | 1.78 | 0.050 | 1.27 | 0.054 | 1.37 | 0.088 | 2.24 | 0.093 | 2.36 | 0.098 | 2.49 | 0.104 | 2.64 |
| A008XXXXXX | 0.075 | 1.91 | 0.054 | 1.37 | 0.058 | 1.47 | 0.093 | 2.36 | 0.098 | 2.49 | 0.104 | 2.64 | 0.110 | 2.79 |
| A009XXXXXX | 0.079 | 2.01 | 0.057 | 1.45 | 0.061 | 1.55 | 0.098 | 2.49 | 0.103 | 2.62 | 0.109 | 2.77 | 0.115 | 2.92 |
| A010XXXXXX | 0.085 | 2.16 | 0.061 | 1.55 | 0.066 | 1.68 | 0.105 | 2.67 | 0.110 | 2.79 | 0.117 | 2.97 | 0.123 | 3.12 |
| A011XXXXXX | 0.090 | 2.29 | 0.065 | 1.65 | 0.069 | 1.75 | 0.111 | 2.82 | 0.116 | 2.95 | 0.124 | 3.15 | 0.130 | 3.30 |
| A012XXXXXX | 0.093 | 2.36 | 0.067 | 1.70 | 0.072 | 1.83 | 0.114 | 2.90 | 0.119 | 3.02 | 0.127 | 3.23 | 0.133 | 3.38 |
| A013XXXXXX | 0.103 | 2.62 | 0.074 | 1.88 | 0.079 | 2.01 | 0.126 | 3.20 | 0.131 | 3.33 | 0.140 | 3.56 | 0.146 | 3.71 |
| A014XXXXXX | 0.112 | 2.84 | 0.080 | 2.03 | 0.086 | 2.18 | 0.136 | 3.45 | 0.141 | 3.58 | 0.152 | 3.86 | 0.158 | 4.01 |
| A015XXXXXX | 0.118 | 3.00 | 0.085 | 2.16 | 0.091 | 2.31 | 0.143 | 3.63 | 0.148 | 3.76 | 0.160 | 4.06 | 0.166 | 4.22 |
| A016XXXXXX | 0.125 | 3.18 | 0.090 | 2.29 | 0.096 | 2.44 | 0.151 | 3.84 | 0.156 | 3.96 | 0.169 | 4.29 | 0.175 | 4.45 |
| A017XXXXXX | 0.130 | 3.30 | 0.093 | 2.36 | 0.100 | 2.54 | 0.157 | 3.99 | 0.162 | 4.11 | 0.175 | 4.45 | 0.181 | 4.60 |
| A018XXXXXX | 0.139 | 3.53 | 0.101 | 2.57 | 0.107 | 2.72 | 0.167 | 4.24 | 0.172 | 4.37 | 0.187 | 4.75 | 0.197 | 5.00 |
| A019XXXXXX | 0.147 | 3.73 | 0.107 | 2.72 | 0.117 | 2.97 | 0.176 | 4.47 | 0.181 | 4.60 | 0.197 | 5.00 | 0.207 | 5.26 |
| A020XXXXXX | 0.156 | 3.96 | 0.113 | 2.87 | 0.123 | 3.12 | 0.187 | 4.75 | 0.192 | 4.88 | 0.209 | 5.31 | 0.219 | 5.56 |
| A021XXXXXX | 0.177 | 4.50 | 0.129 | 3.28 | 0.139 | 3.53 | 0.211 | 5.36 | 0.216 | 5.49 | 0.235 | 5.97 | 0.145 | 3.68 |
| A022XXXXXX | 0.188 | 4.78 | 0.137 | 3.48 | 0.147 | 3.73 | 0.223 | 5.66 | 0.228 | 5.79 | 0.249 | 6.32 | 0.259 | 6.58 |
| A023XXXXXX | 0.197 | 5.00 | 0.143 | 3.63 | 0.153 | 3.89 | 0.233 | 5.92 | 0.238 | 6.05 | 0.261 | 6.63 | 0.271 | 6.88 |
| A024XXXXXX | 0.210 | 5.33 | 0.152 | 3.86 | 0.162 | 4.11 | 0.251 | 6.38 | 0.256 | 6.50 | 0.281 | 7.14 | 0.291 | 7.39 |
| A025XXXXXX | 0.220 | 5.59 | 0.159 | 4.04 | 0.169 | 4.29 | 0.263 | 6.68 | 0.268 | 6.81 | 0.294 | 7.47 | 0.304 | 7.72 |
| A026XXXXXX | 0.236 | 5.99 | 0.171 | 4.34 | 0.181 | 4.60 | 0.281 | 7.14 | 0.286 | 7.26 | 0.314 | 7.98 | 0.324 | 8.23 |
| A027XXXXXX | 0.250 | 6.35 | 0.183 | 4.65 | 0.193 | 4.90 | 0.294 | 7.47 | 0.299 | 7.59 | 0.329 | 8.36 | 0.339 | 8.61 |
| A028XXXXXX | 0.275 | 6.99 | 0.201 | 5.11 | 0.211 | 5.36 | 0.325 | 8.26 | 0.330 | 8.38 | 0.363 | 9.22 | 0.373 | 9.47 |
| A029XXXXXX | 0.282 | 7.16 | 0.206 | 5.23 | 0.216 | 5.49 | 0.333 | 8.46 | 0.338 | 8.59 | 0.372 | 9.45 | 0.382 | 9.70 |
| A030XXXXXX | 0.312 | 7.92 | 0.228 | 5.79 | 0.238 | 6.05 | 0.367 | 9.32 | 0.372 | 9.45 | 0.410 | 10.41 | 0.420 | 10.67 |
| A031XXXXXX | 0.324 | 8.23 | 0.237 | 6.02 | 0.247 | 6.27 | 0.380 | 9.65 | 0.385 | 9.78 | 0.425 | 10.80 | 0.435 | 11.05 |
| A032XXXXXX | 0.348 | 8.84 | 0.524 | 13.31 | 0.264 | 6.71 | 0.407 | 10.34 | 0.412 | 10.46 | 0.455 | 11.56 | 0.465 | 11.81 |
| A033XXXXXX | 0.375 | 9.53 | 0.276 | 7.01 | 0.286 | 7.26 | 0.437 | 11.10 | 0.442 | 11.23 | 0.489 | 12.42 | 0.499 | 12.67 |
| A034XXXXXX | 0.393 | 9.98 | 0.289 | 7.34 | 0.299 | 7.59 | 0.457 | 11.61 | 0.462 | 11.73 | 0.511 | 12.98 | 0.521 | 13.23 |
| A035XXXXXX | 0.429 | 10.90 | 0.316 | 8.03 | 0.326 | 8.28 | 0.498 | 12.65 | 0.503 | 12.78 | 0.556 | 14.12 | 0.566 | 14.38 |
| A036XXXXXX | 0.479 | 12.17 | 0.353 | 8.97 | 0.363 | 9.22 | 0.554 | 14.07 | 0.559 | 14.20 | 0.619 | 15.72 | 0.629 | 15.98 |
| A037XXXXXX | 0.500 | 12.70 | 0.370 | 9.40 | 0.380 | 9.65 | 0.577 | 14.66 | 0.582 | 14.78 | 0.644 | 16.36 | 0.654 | 16.61 |
| A038XXXXXX | 0.562 | 14.27 | 0.416 | 10.57 | 0.426 | 10.82 | 0.650 | 16.51 | 0.655 | 16.64 | 0.727 | 18.47 | 0.737 | 18.72 |
| A039XXXXXX | 0.635 | 16.13 | 0.470 | 11.94 | 0.480 | 12.19 | 0.732 | 18.59 | 0.737 | 18.72 | 0.818 | 20.78 | 0.828 | 21.03 |

NOTES: (1) All of the above part numbers are extrudable in silicone materials.

(2) Smallest and largest sizes may not be extrudable in non-silicone materials. Contact the TechSeal Division's Applications Engineering Department for more specific information.

(3) Tooling is available for any size O.D. from .040 through 1.000". Contact TechSeal for size availability on sizes not listed in the above table.

Standard Profiles Guide - Hollow-O



Table 12. Hollow O - TechSeal Configuration “B” Designation

Please refer to page 36 for how to specify a standard TechSeal part number.

| TechSeal Profile Part Number | A Outside Diameter | | B Inside Diameter | | Groove Depth | | | | Groove Width | | | |
|------------------------------|--------------------|-------|-------------------|------|--------------|------|--------|------|--------------|-------|--------|-------|
| | | | | | Min | | Max | | Min | | Max | |
| | inches | mm | inches | mm | inches | mm | inches | mm | inches | mm | inches | mm |
| B001XXXXXX | 0.040 | 1.02 | 0.015 | 0.38 | 0.029 | 0.74 | 0.031 | 0.79 | 0.053 | 1.35 | 0.058 | 1.47 |
| B002XXXXXX | 0.053 | 1.35 | 0.027 | 0.69 | 0.038 | 0.97 | 0.041 | 1.04 | 0.068 | 1.73 | 0.073 | 1.85 |
| B003XXXXXX | 0.062 | 1.57 | 0.035 | 0.89 | 0.045 | 1.14 | 0.048 | 1.22 | 0.078 | 1.99 | 0.083 | 2.11 |
| B004XXXXXX | 0.070 | 1.78 | 0.030 | 0.76 | 0.050 | 1.27 | 0.054 | 1.37 | 0.088 | 2.23 | 0.093 | 2.36 |
| B005XXXXXX | 0.070 | 1.78 | 0.040 | 1.02 | 0.050 | 1.27 | 0.054 | 1.37 | 0.088 | 2.23 | 0.093 | 2.36 |
| B006XXXXXX | 0.073 | 1.85 | 0.043 | 1.09 | 0.052 | 1.32 | 0.056 | 1.42 | 0.091 | 2.31 | 0.096 | 2.44 |
| B007XXXXXX | 0.083 | 2.11 | 0.043 | 1.09 | 0.060 | 1.52 | 0.064 | 1.63 | 0.103 | 2.60 | 0.108 | 2.74 |
| B008XXXXXX | 0.083 | 2.11 | 0.050 | 1.27 | 0.060 | 1.52 | 0.064 | 1.63 | 0.103 | 2.60 | 0.108 | 2.74 |
| B009XXXXXX | 0.090 | 2.29 | 0.050 | 1.27 | 0.065 | 1.65 | 0.069 | 1.75 | 0.111 | 2.81 | 0.116 | 2.95 |
| B010XXXXXX | 0.103 | 2.62 | 0.040 | 1.02 | 0.074 | 1.88 | 0.079 | 2.01 | 0.126 | 3.19 | 0.131 | 3.33 |
| B011XXXXXX | 0.103 | 2.62 | 0.062 | 1.57 | 0.074 | 1.88 | 0.079 | 2.01 | 0.126 | 3.19 | 0.131 | 3.33 |
| B012XXXXXX | 0.118 | 3.00 | 0.079 | 2.01 | 0.085 | 2.16 | 0.091 | 2.31 | 0.143 | 3.63 | 0.148 | 3.76 |
| B013XXXXXX | 0.125 | 3.18 | 0.062 | 1.57 | 0.090 | 2.29 | 0.096 | 2.44 | 0.151 | 3.83 | 0.156 | 3.96 |
| B014XXXXXX | 0.125 | 3.18 | 0.080 | 2.03 | 0.090 | 2.29 | 0.096 | 2.44 | 0.151 | 3.83 | 0.156 | 3.96 |
| B015XXXXXX | 0.139 | 3.53 | 0.070 | 1.78 | 0.101 | 2.57 | 0.107 | 2.72 | 0.167 | 4.25 | 0.172 | 4.37 |
| B016XXXXXX | 0.156 | 3.96 | 0.050 | 1.27 | 0.113 | 2.87 | 0.123 | 3.12 | 0.187 | 4.47 | 0.192 | 4.88 |
| B017XXXXXX | 0.156 | 3.96 | 0.096 | 2.44 | 0.113 | 2.87 | 0.123 | 3.12 | 0.187 | 4.47 | 0.192 | 4.88 |
| B018XXXXXX | 0.177 | 4.50 | 0.077 | 1.96 | 0.129 | 3.28 | 0.139 | 3.53 | 0.211 | 5.35 | 0.216 | 5.49 |
| B019XXXXXX | 0.177 | 4.50 | 0.127 | 3.23 | 0.129 | 3.28 | 0.139 | 3.53 | 0.211 | 5.35 | 0.216 | 5.49 |
| B020XXXXXX | 0.210 | 5.33 | 0.100 | 2.54 | 0.152 | 3.86 | 0.162 | 4.11 | 0.251 | 6.39 | 0.256 | 6.50 |
| B021XXXXXX | 0.210 | 5.33 | 0.150 | 3.81 | 0.152 | 3.86 | 0.162 | 4.11 | 0.251 | 6.39 | 0.256 | 6.50 |
| B022XXXXXX | 0.250 | 6.35 | 0.125 | 3.18 | 0.183 | 4.65 | 0.193 | 4.90 | 0.294 | 7.47 | 0.299 | 7.59 |
| B023XXXXXX | 0.250 | 6.35 | 0.170 | 4.32 | 0.183 | 4.65 | 0.193 | 4.90 | 0.294 | 7.47 | 0.299 | 7.59 |
| B024XXXXXX | 0.312 | 7.95 | 0.192 | 4.88 | 0.228 | 5.79 | 0.238 | 6.05 | 0.367 | 9.31 | 0.372 | 9.45 |
| B025XXXXXX | 0.375 | 9.53 | 0.250 | 6.35 | 0.276 | 7.01 | 0.286 | 7.26 | 0.437 | 11.10 | 0.442 | 11.23 |
| B026XXXXXX | 0.500 | 12.70 | 0.380 | 9.65 | 0.370 | 9.40 | 0.380 | 9.65 | 0.577 | 14.65 | 0.582 | 14.78 |

NOTES:

- (1) All of the above part numbers are extrudable in silicone materials.
- (2) Smallest and largest sizes may not be extrudable in non-silicone materials. Contact the TechSeal Division's Applications Engineering Department for more specific information.
- (3) Tooling is available for any size O.D. from .040 through 1.000". Contact TechSeal for size availability on sizes not listed in the above table.

PROFILES

Standard Profiles Guide - Hollow-O

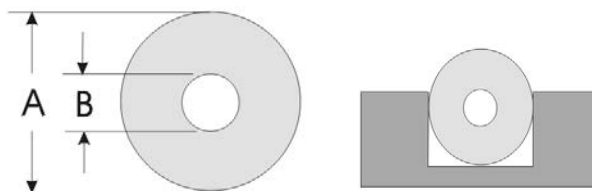

Table 13. Hollow O - TechSeal Configuration “B” Designation Friction Fit Series

Please refer to page 36 for how to specify a standard TechSeal part number.

| TechSeal Profile Part Number | A Outside Diameter | | B Inside Diameter | | Groove Depth | | | | Groove Width | | | |
|------------------------------|--------------------|-------|-------------------|------|--------------|------|--------|------|--------------|-------|--------|-------|
| | inches | mm | inches | mm | Min | | Max | | Min | | Max | |
| | | | | | inches | mm | inches | mm | inches | mm | inches | mm |
| B008XXXXXX | 0.083 | 2.11 | 0.050 | 1.27 | 0.056 | 1.43 | 0.060 | 1.53 | 0.071 | 1.81 | 0.075 | 1.91 |
| B009XXXXXX | 0.090 | 2.29 | 0.050 | 1.27 | 0.061 | 1.55 | 0.065 | 1.65 | 0.078 | 1.99 | 0.082 | 2.09 |
| B010XXXXXX | 0.103 | 2.62 | 0.040 | 1.02 | 0.076 | 1.93 | 0.080 | 2.03 | 0.096 | 2.44 | 0.100 | 2.54 |
| B011XXXXXX | 0.103 | 2.62 | 0.062 | 1.57 | 0.070 | 1.78 | 0.074 | 1.88 | 0.091 | 2.32 | 0.095 | 2.42 |
| B012XXXXXX | 0.118 | 3.00 | 0.079 | 2.01 | 0.081 | 2.05 | 0.085 | 2.15 | 0.106 | 2.70 | 0.110 | 2.80 |
| B013XXXXXX | 0.125 | 3.18 | 0.062 | 1.57 | 0.090 | 2.29 | 0.094 | 2.39 | 0.113 | 2.88 | 0.117 | 2.98 |
| B014XXXXXX | 0.125 | 3.18 | 0.080 | 2.03 | 0.086 | 2.17 | 0.090 | 2.29 | 0.113 | 2.88 | 0.117 | 2.98 |
| B015XXXXXX | 0.139 | 3.52 | 0.070 | 1.78 | 0.098 | 2.49 | 0.102 | 2.57 | 0.126 | 3.20 | 0.130 | 3.30 |
| B017XXXXXX | 0.156 | 3.96 | 0.096 | 2.44 | 0.107 | 2.72 | 0.111 | 2.82 | 0.139 | 3.53 | 0.143 | 3.63 |
| B018XXXXXX | 0.177 | 4.50 | 0.077 | 1.96 | 0.132 | 3.35 | 0.138 | 3.51 | 0.161 | 4.09 | 0.167 | 4.24 |
| B019XXXXXX | 0.177 | 4.50 | 0.127 | 3.23 | 0.121 | 3.07 | 0.127 | 3.23 | 0.159 | 4.04 | 0.165 | 4.20 |
| B020XXXXXX | 0.210 | 5.33 | 0.100 | 2.54 | 0.147 | 3.71 | 0.153 | 3.89 | 0.194 | 4.93 | 0.200 | 5.08 |
| B021XXXXXX | 0.210 | 5.33 | 0.150 | 3.81 | 0.144 | 3.65 | 0.150 | 3.81 | 0.192 | 4.87 | 0.198 | 5.03 |
| B022XXXXXX | 0.250 | 6.35 | 0.125 | 3.18 | 0.172 | 4.37 | 0.178 | 4.53 | 0.232 | 5.89 | 0.238 | 6.05 |
| B023XXXXXX | 0.250 | 6.35 | 0.170 | 4.32 | 0.172 | 4.37 | 0.178 | 4.53 | 0.232 | 5.89 | 0.238 | 6.05 |
| B024XXXXXX | 0.312 | 7.92 | 0.192 | 4.88 | 0.215 | 5.47 | 0.221 | 5.63 | 0.289 | 7.33 | 0.295 | 7.49 |
| B025XXXXXX | 0.375 | 9.53 | 0.250 | 6.35 | 0.260 | 6.59 | 0.266 | 6.75 | 0.352 | 8.94 | 0.358 | 9.10 |
| B026XXXXXX | 0.500 | 12.70 | 0.380 | 9.65 | 0.347 | 8.81 | 0.353 | 8.79 | 0.477 | 12.11 | 0.483 | 12.27 |

NOTES:

- (1) All of the above part numbers are extrudable in silicone materials.
- (2) All groove dimensions are based on 28% compression and 95% gland fill.
- (3) Smallest and largest sizes may not be extrudable in non-silicone materials. Contact the TechSeal Division’s Applications Engineering Department for more specific information.
- (4) Tooling is available for any size Hollow-O O.D. from .040 through 1.000”. Some limitations do exist for minimal wall dimensions. Contact TechSeal for size availability.

Standard Profiles Guide - Solid-D

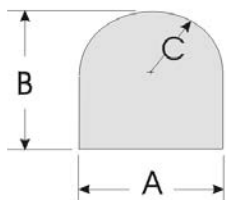

Table 14. Solid D - TechSeal Configuration “C” Designation

Please refer to page 36 for how to specify a standard TechSeal part number.

| TechSeal Profile Part Number | Nominal Dimensions | | | | | | Suggested Groove Depth | | | | Suggested Groove Width | | | |
|------------------------------|--------------------|-------|--------|-------|--------|------|------------------------|-------|--------|-------|------------------------|-------|--------|-------|
| | B | | A | | C | | Min | | Max | | Min | | Max | |
| | inches | mm | inches | mm | inches | mm | inches | mm | inches | mm | inches | mm | inches | mm |
| C001XXXXXX | 0.064 | 1.63 | 0.055 | 1.40 | 0.031 | 0.79 | 0.050 | 1.27 | 0.054 | 1.37 | 0.078 | 1.98 | 0.082 | 2.08 |
| C002XXXXXX | 0.075 | 1.91 | 0.060 | 1.52 | 0.030 | 0.76 | 0.060 | 1.52 | 0.064 | 1.63 | 0.083 | 2.11 | 0.087 | 2.21 |
| C003XXXXXX | 0.068 | 1.73 | 0.062 | 1.57 | 0.031 | 0.79 | 0.054 | 1.37 | 0.058 | 1.47 | 0.086 | 2.18 | 0.090 | 2.29 |
| C004XXXXXX | 0.074 | 1.88 | 0.062 | 1.57 | 0.031 | 0.79 | 0.059 | 1.50 | 0.063 | 1.60 | 0.086 | 2.18 | 0.090 | 2.29 |
| C005XXXXXX | 0.085 | 2.16 | 0.062 | 1.57 | 0.031 | 0.79 | 0.070 | 1.78 | 0.074 | 1.88 | 0.086 | 2.18 | 0.090 | 2.29 |
| C006XXXXXX | 0.100 | 2.54 | 0.062 | 1.57 | 0.031 | 0.79 | 0.083 | 2.11 | 0.087 | 2.21 | 0.087 | 2.21 | 0.091 | 2.31 |
| C007XXXXXX | 0.055 | 1.40 | 0.064 | 1.63 | 0.032 | 0.81 | 0.042 | 1.07 | 0.046 | 1.17 | 0.090 | 2.29 | 0.094 | 2.39 |
| C008XXXXXX | 0.095 | 2.41 | 0.070 | 1.78 | 0.035 | 0.89 | 0.079 | 2.01 | 0.083 | 2.11 | 0.092 | 2.34 | 0.096 | 2.44 |
| C009XXXXXX | 0.089 | 2.26 | 0.078 | 1.98 | 0.039 | 0.99 | 0.072 | 1.83 | 0.076 | 1.93 | 0.103 | 2.62 | 0.107 | 2.72 |
| C010XXXXXX | 0.070 | 1.78 | 0.080 | 2.03 | 0.040 | 1.02 | 0.056 | 1.42 | 0.060 | 1.52 | 0.106 | 2.69 | 0.110 | 2.79 |
| C011XXXXXX | 0.090 | 2.29 | 0.080 | 2.03 | 0.040 | 1.02 | 0.074 | 1.88 | 0.078 | 1.98 | 0.111 | 2.82 | 0.115 | 2.92 |
| C012XXXXXX | 0.081 | 2.06 | 0.088 | 2.24 | 0.044 | 1.12 | 0.066 | 1.68 | 0.070 | 1.78 | 0.115 | 2.92 | 0.119 | 3.02 |
| C013XXXXXX | 0.134 | 3.40 | 0.091 | 2.31 | 0.045 | 1.14 | 0.115 | 2.92 | 0.119 | 3.02 | 0.121 | 3.07 | 0.125 | 3.18 |
| C014XXXXXX | 0.078 | 1.98 | 0.094 | 2.39 | 0.047 | 1.19 | 0.063 | 1.60 | 0.067 | 1.70 | 0.121 | 3.07 | 0.125 | 3.18 |
| C015XXXXXX | 0.094 | 2.39 | 0.094 | 2.39 | 0.047 | 1.19 | 0.078 | 1.98 | 0.082 | 2.08 | 0.122 | 3.10 | 0.126 | 3.20 |
| C016XXXXXX | 0.115 | 2.92 | 0.102 | 2.59 | 0.051 | 1.30 | 0.097 | 2.46 | 0.101 | 2.57 | 0.134 | 3.40 | 0.138 | 3.51 |
| C017XXXXXX | 0.131 | 3.33 | 0.122 | 3.10 | 0.061 | 1.55 | 0.112 | 2.84 | 0.116 | 2.95 | 0.159 | 4.04 | 0.163 | 4.14 |
| C018XXXXXX | 0.156 | 3.96 | 0.156 | 3.96 | 0.078 | 1.98 | 0.135 | 3.43 | 0.139 | 3.53 | 0.197 | 5.00 | 0.201 | 5.11 |
| C019XXXXXX | 0.200 | 5.08 | 0.187 | 4.75 | 0.093 | 2.36 | 0.175 | 4.45 | 0.179 | 4.55 | 0.231 | 5.87 | 0.235 | 5.97 |
| C020XXXXXX | 0.188 | 4.78 | 0.188 | 4.78 | 0.094 | 2.39 | 0.164 | 4.17 | 0.168 | 4.27 | 0.213 | 5.41 | 0.235 | 5.97 |
| C033XXXXXX | 0.250 | 6.35 | 0.250 | 6.35 | 0.125 | 3.18 | 0.213 | 5.41 | 0.217 | 5.51 | 0.309 | 7.85 | 0.313 | 7.95 |
| C034XXXXXX | 0.312 | 7.92 | 0.312 | 7.92 | 0.156 | 3.96 | 0.265 | 6.73 | 0.269 | 6.83 | 0.386 | 9.80 | 0.390 | 9.91 |
| C035XXXXXX | 0.312 | 7.92 | 0.488 | 12.40 | 0.244 | 6.20 | 0.265 | 6.73 | 0.269 | 6.83 | 0.562 | 14.27 | 0.566 | 14.38 |
| C036XXXXXX | 0.500 | 12.70 | 0.502 | 12.75 | 0.250 | 6.35 | 0.425 | 10.80 | 0.429 | 10.90 | 0.619 | 15.72 | 0.623 | 15.82 |

PSA is available on any TechSeal Division extrusion with a flat side minimum width of 0.125” [3.18 mm].

Please contact TechSeal to obtain the modified part numbers.

NOTES:

- (1) All of the above part numbers are extrudable in silicone materials.
- (2) Smallest and largest sizes may not be extrudable in non-silicone materials. Contact the TechSeal Division’s Applications Engineering Department for more specific information.

PROFILES

Standard Profiles Guide - Hollow-D

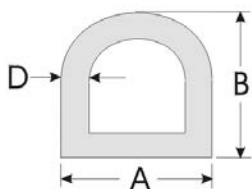

Table 15. Hollow D - TechSeal Configuration “D” Designation

Please refer to page 36 for how to specify a standard TechSeal part number.

Total Height = B

| TechSeal Profile Part Number | Nominal Dimensions | | | | | |
|------------------------------|--------------------|-------|--------|-------|--------|------|
| | A | | B | | D | |
| | inches | mm | inches | mm | inches | mm |
| D001XXXXXX | 0.156 | 3.96 | 0.156 | 3.96 | 0.045 | 1.14 |
| D002XXXXXX | 0.187 | 4.75 | 0.186 | 4.72 | 0.050 | 1.27 |
| D003XXXXXX | 0.187 | 4.75 | 0.227 | 5.76 | 0.040 | 1.02 |
| D004XXXXXX | 0.207 | 5.26 | 0.187 | 4.75 | 0.050 | 1.27 |
| D006XXXXXX | 0.250 | 6.35 | 0.250 | 6.36 | 0.062 | 1.57 |
| D007XXXXXX | 0.250 | 6.35 | 0.250 | 6.36 | 0.065 | 1.65 |
| D008XXXXXX | 0.296 | 7.52 | 0.322 | 8.18 | 0.050 | 1.27 |
| D009XXXXXX | 0.312 | 7.92 | 0.312 | 7.92 | 0.062 | 1.57 |
| D010XXXXXX | 0.488 | 12.40 | 0.312 | 7.93 | 0.055 | 1.40 |
| D011XXXXXX | 0.487 | 12.37 | 0.324 | 8.23 | 0.035 | 0.89 |
| D012XXXXXX | 0.487 | 12.37 | 0.324 | 8.23 | 0.045 | 1.14 |
| D013XXXXXX | 0.487 | 12.37 | 0.324 | 8.23 | 0.062 | 1.57 |
| D014XXXXXX | 0.487 | 12.37 | 0.324 | 8.23 | 0.080 | 2.03 |
| D015XXXXXX | 0.502 | 12.75 | 0.500 | 12.70 | 0.061 | 1.55 |
| D016XXXXXX | 0.700 | 17.78 | 0.600 | 15.24 | 0.100 | 2.54 |
| D017XXXXXX | 0.750 | 19.05 | 0.750 | 19.06 | 0.075 | 1.91 |
| D018XXXXXX | 0.975 | 24.77 | 0.620 | 15.75 | 0.093 | 2.36 |

PSA is available on any TechSeal Division extrusion with a flat side minimum width of 0.125” [3.18 mm]. Please contact TechSeal to obtain the modified part numbers.

NOTES:

- (1) All of the above part numbers are extrudable in silicone materials.
- (2) Smallest and largest sizes may not be extrudable in non-silicone materials. Contact the TechSeal Division’s Applications Engineering Department for more specific information.

Standard Profiles Guide - U-Channel

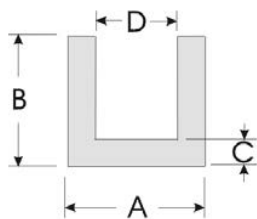

Table 16. U-Channel - TechSeal Configuration “E” Designation

Please refer to page 36 for how to specify a standard TechSeal part number.

| TechSeal Profile Part Number | Nominal Dimensions | | | | | | | |
|------------------------------|--------------------|-------|--------|-------|--------|------|--------|------|
| | A | | B | | C | | D | |
| | inches | mm | inches | mm | inches | mm | inches | mm |
| E001XXXXXX | 0.075 | 1.91 | 0.099 | 2.51 | 0.025 | 0.64 | 0.032 | 0.81 |
| E002XXXXXX | 0.100 | 2.54 | 0.100 | 2.54 | 0.034 | 0.86 | 0.033 | 0.84 |
| E003XXXXXX | 0.126 | 3.20 | 0.078 | 1.98 | 0.044 | 1.12 | 0.048 | 1.22 |
| E004XXXXXX | 0.126 | 3.20 | 0.099 | 2.51 | 0.047 | 1.19 | 0.059 | 1.50 |
| E005XXXXXX | 0.126 | 3.20 | 0.097 | 2.46 | 0.026 | 0.66 | 0.037 | 0.94 |
| E006XXXXXX | 0.126 | 3.20 | 0.110 | 2.79 | 0.025 | 0.64 | 0.050 | 1.27 |
| E007XXXXXX | 0.126 | 3.20 | 0.225 | 5.72 | 0.020 | 0.51 | 0.075 | 1.91 |
| E008XXXXXX | 0.154 | 3.91 | 0.154 | 3.91 | 0.082 | 2.08 | 0.088 | 2.24 |
| E009XXXXXX | 0.154 | 3.91 | 0.156 | 3.96 | 0.062 | 1.57 | 0.040 | 1.02 |
| E010XXXXXX | 0.156 | 3.96 | 0.175 | 4.45 | 0.046 | 1.17 | 0.075 | 1.91 |
| E011XXXXXX | 0.175 | 4.45 | 0.156 | 3.96 | 0.047 | 1.19 | 0.075 | 1.91 |
| E012XXXXXX | 0.188 | 4.78 | 0.188 | 4.78 | 0.062 | 1.57 | 0.062 | 1.57 |
| E013XXXXXX | 0.193 | 4.90 | 0.193 | 4.90 | 0.128 | 3.25 | 0.064 | 1.63 |
| E014XXXXXX | 0.250 | 6.35 | 0.250 | 6.35 | 0.170 | 4.32 | 0.062 | 1.57 |
| E015XXXXXX | 0.250 | 6.35 | 0.250 | 6.35 | 0.130 | 3.30 | 0.062 | 1.57 |
| E016XXXXXX | 0.260 | 6.60 | 0.184 | 4.67 | 0.140 | 3.56 | 0.062 | 1.57 |
| E017XXXXXX | 0.320 | 8.13 | 0.315 | 8.00 | 0.193 | 4.90 | 0.197 | 5.00 |
| E018XXXXXX | 0.327 | 8.31 | 0.235 | 5.97 | 0.062 | 1.57 | 0.115 | 2.92 |
| E019XXXXXX | 0.375 | 9.53 | 0.500 | 12.70 | 0.187 | 4.75 | 0.125 | 3.18 |
| E020XXXXXX | 0.500 | 12.70 | 0.500 | 12.70 | 0.250 | 6.35 | 0.125 | 3.18 |

PSA is available on any TechSeal extrusion with a flat side minimum width of 0.125” [3.18 mm].

Please contact TechSeal to obtain the modified part numbers.

NOTES:

- (1) All of the above part numbers are extrudable in silicone materials.
- (2) Smallest and largest sizes may not be extrudable in non-silicone materials. Contact the TechSeal Division’s Applications Engineering Department for more specific information.
- (3) Some configurations may have a degree of curvature, making them unsuitable in long lengths. Contact TechSeal Applications Engineering for details.

Standard Profiles Guide - Rectangle and Square



Table 17. Rectangular Profile TechSeal Configuration “F” Designation

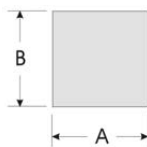

Table 18. Rectangular Profile TechSeal Configuration “G” Designation

Please refer to page 36 for how to specify a standard TechSeal part number.

| TechSeal Profile Part Number | Nominal Dimensions | | | |
|------------------------------|--------------------|-------|--------|------|
| | A | | B | |
| | inches | mm | inches | mm |
| F001XXXXXX | 0.095 | 2.41 | 0.062 | 1.57 |
| F002XXXXXX | 0.125 | 3.18 | 0.062 | 1.57 |
| F003XXXXXX | 0.156 | 3.96 | 0.062 | 1.57 |
| F004XXXXXX | 0.158 | 4.01 | 0.062 | 1.57 |
| F005XXXXXX | 0.250 | 6.35 | 0.062 | 1.57 |
| F006XXXXXX | 0.500 | 12.70 | 0.062 | 1.57 |
| F007XXXXXX | 0.569 | 14.45 | 0.062 | 1.57 |
| F008XXXXXX | 0.750 | 19.05 | 0.062 | 1.57 |
| F009XXXXXX | 0.880 | 22.35 | 0.062 | 1.57 |
| F010XXXXXX | 1.000 | 25.40 | 0.062 | 1.57 |
| F011XXXXXX | 0.120 | 3.05 | 0.075 | 1.91 |
| F012XXXXXX | 0.250 | 6.35 | 0.075 | 1.91 |
| F013XXXXXX | 0.500 | 12.70 | 0.075 | 1.91 |
| F014XXXXXX | 0.125 | 3.18 | 0.093 | 2.36 |
| F015XXXXXX | 0.188 | 4.78 | 0.093 | 2.36 |
| F016XXXXXX | 0.250 | 6.35 | 0.093 | 2.36 |
| F017XXXXXX | 0.500 | 12.70 | 0.093 | 2.36 |
| F018XXXXXX | 0.170 | 4.32 | 0.125 | 3.18 |
| F019XXXXXX | 0.250 | 6.35 | 0.125 | 3.18 |
| F020XXXXXX | 0.500 | 12.70 | 0.125 | 3.18 |
| F021XXXXXX | 0.750 | 19.05 | 0.125 | 3.18 |
| F022XXXXXX | 1.000 | 25.40 | 0.125 | 3.18 |
| F023XXXXXX | 0.500 | 12.70 | 0.188 | 4.78 |
| F024XXXXXX | 0.500 | 12.70 | 0.250 | 6.35 |
| F025XXXXXX | 1.000 | 25.40 | 0.250 | 6.35 |

| TechSeal Profile Part Number | Nominal Dimensions | | | |
|------------------------------|--------------------|-------|--------|-------|
| | A | | B | |
| | inches | mm | inches | mm |
| G001XXXXXX | 0.053 | 1.35 | 0.053 | 1.35 |
| G002XXXXXX | 0.066 | 1.68 | 0.066 | 1.68 |
| G003XXXXXX | 0.070 | 1.78 | 0.070 | 1.78 |
| G004XXXXXX | 0.099 | 2.51 | 0.099 | 2.51 |
| G005XXXXXX | 0.103 | 2.62 | 0.103 | 2.62 |
| G006XXXXXX | 0.134 | 3.40 | 0.134 | 3.40 |
| G007XXXXXX | 0.139 | 3.53 | 0.139 | 3.53 |
| G008XXXXXX | 0.203 | 5.16 | 0.203 | 5.16 |
| G009XXXXXX | 0.210 | 5.33 | 0.210 | 5.33 |
| G010XXXXXX | 0.265 | 6.73 | 0.265 | 6.73 |
| G011XXXXXX | 0.275 | 6.99 | 0.275 | 6.99 |
| G012XXXXXX | 0.360 | 9.14 | 0.360 | 9.14 |
| G013XXXXXX | 0.375 | 9.53 | 0.375 | 9.53 |
| G014XXXXXX | 0.480 | 12.19 | 0.480 | 12.19 |
| G015XXXXXX | 0.500 | 12.70 | 0.500 | 12.70 |

PSA is available on any TechSeal extrusion with a flat side minimum width of 0.125” [3.18 mm]. Please contact TechSeal to obtain the modified part numbers.

NOTES:

- (1) All of the above part numbers are extrudable in silicone materials.
- (2) Smallest and largest sizes may not be extrudable in non-silicone materials. Contact the TechSeal Division’s Applications Engineering Department for more specific information.
- (3) Some configurations may have a degree of curvature, making them unsuitable in long lengths. Contact TechSeal Application Engineering for details.

Standard Profiles Guide - Hollow Square, P & Omega

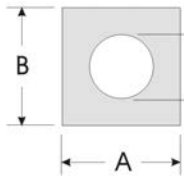

Table 19. Hollow Square TechSeal Configuration “H” Designation

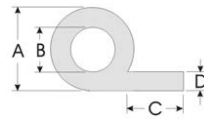

Table 20. Hollow P TechSeal Configuration “P” Designation

Please refer to page 36 for how to specify a standard TechSeal part number.

| TechSeal Profile Part Number | Nominal Dimensions | | | | | |
|------------------------------|--------------------|-------|--------|-------|----------|------|
| | A | | B | | C (dia.) | |
| | inches | mm | inches | mm | inches | mm |
| H001XXXXXX | 0.053 | 1.35 | 0.053 | 1.35 | 0.020 | 0.51 |
| H002XXXXXX | 0.066 | 1.68 | 0.066 | 1.68 | 0.020 | 0.51 |
| H003XXXXXX | 0.070 | 1.78 | 0.070 | 1.78 | 0.025 | 0.64 |
| H004XXXXXX | 0.099 | 2.51 | 0.099 | 2.51 | 0.025 | 0.64 |
| H005XXXXXX | 0.103 | 2.62 | 0.103 | 2.62 | 0.025 | 0.64 |
| H006XXXXXX | 0.134 | 3.40 | 0.134 | 3.40 | 0.060 | 1.52 |
| H007XXXXXX | 0.139 | 3.53 | 0.139 | 3.53 | 0.060 | 1.52 |
| H008XXXXXX | 0.203 | 5.16 | 0.203 | 5.16 | 0.080 | 2.03 |
| H009XXXXXX | 0.210 | 5.33 | 0.210 | 5.33 | 0.080 | 2.03 |
| H010XXXXXX | 0.265 | 6.73 | 0.265 | 6.73 | 0.100 | 2.54 |
| H011XXXXXX | 0.275 | 6.99 | 0.275 | 6.99 | 0.100 | 2.54 |
| H012XXXXXX | 0.360 | 9.14 | 0.360 | 9.14 | 0.125 | 3.18 |
| H013XXXXXX | 0.375 | 9.53 | 0.375 | 9.53 | 0.125 | 3.18 |
| H014XXXXXX | 0.480 | 12.19 | 0.480 | 12.19 | 0.250 | 6.35 |
| H015XXXXXX | 0.500 | 12.70 | 0.500 | 12.70 | 0.250 | 6.35 |

| TechSeal Profile Part Number | Nominal Dimensions | | | | | | | |
|------------------------------|--------------------|-------|----------|-------|-------|-------|-------|------|
| | A (dia.) | | B (dia.) | | C | | D | |
| | in | mm | in | mm | in | mm | in | mm |
| P001XXXXXX | 0.170 | 4.32 | 0.060 | 1.52 | 0.205 | 5.21 | 0.062 | 1.57 |
| P002XXXXXX | 0.200 | 5.08 | 0.080 | 2.03 | 0.250 | 6.35 | 0.062 | 1.57 |
| P003XXXXXX | 0.200 | 5.08 | 0.080 | 2.03 | 0.550 | 13.97 | 0.062 | 1.57 |
| P004XXXXXX | 0.250 | 6.35 | 0.125 | 3.18 | 0.250 | 6.35 | 0.062 | 1.57 |
| P005XXXXXX | 0.360 | 9.14 | 0.255 | 6.48 | 0.420 | 10.67 | 0.070 | 1.78 |
| P006XXXXXX | 0.600 | 15.24 | 0.400 | 10.16 | 0.350 | 8.89 | 0.110 | 2.79 |

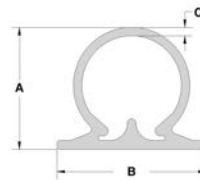

Table 21. Omega TechSeal Configuration “W” Designation

U.S. Patent No. 06075205

| TechSeal Profile Part Number | Nominal Dimensions | | | | | |
|------------------------------|--------------------|-------|--------|-------|----------|------|
| | A | | B | | C (dia.) | |
| | inches | mm | inches | mm | inches | mm |
| W016XXXXXX | 0.728 | 18.49 | 0.890 | 22.61 | 0.065 | 1.65 |
| W034XXXXXX | 0.500 | 12.70 | 0.610 | 15.49 | 0.050 | 1.27 |
| W059XXXXXX | 0.250 | 6.35 | 0.330 | 8.38 | 0.050 | 1.27 |
| W060XXXXXX | 0.360 | 9.14 | 0.499 | 12.67 | 0.050 | 1.27 |
| W061XXXXXX | 0.360 | 9.14 | 0.499 | 12.67 | 0.070 | 1.78 |
| W062XXXXXX | 0.360 | 9.14 | 0.499 | 12.67 | 0.090 | 2.29 |
| W063XXXXXX | 0.360 | 9.14 | 0.490 | 12.45 | 0.080 | 2.03 |

PSA is available on any TechSeal extrusion with a flat side minimum width of 0.125” [3.18 mm].

Please contact TechSeal to obtain the modified part numbers.

NOTES:

- (1) All of the above part numbers are extrudable in silicone materials.
- (2) Smallest and largest sizes may not be extrudable in non-silicone materials. Contact TechSeal Applications Engineering for more specific information.

Custom Profiles Guide

Parker's TechSeal Division supports our customers in the development of custom extruded profiles to solve specific application problems. The following drawings illustrate the wide range of custom extrusion capabilities of the TechSeal Division. If you are interested in using one of these shapes or want to discuss the development of an alternative design, please contact the TechSeal Division's Applications Engineering department. Note that most of these profiles are available in silicone and some may also be available in other polymer families. Contact TechSeal for specific information.

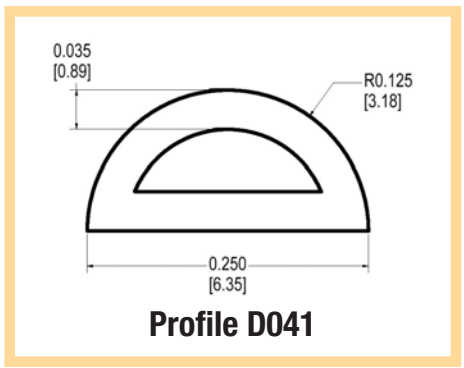
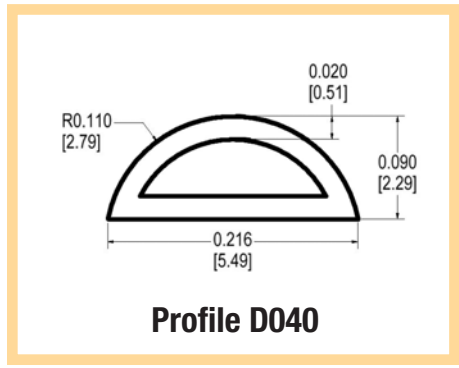
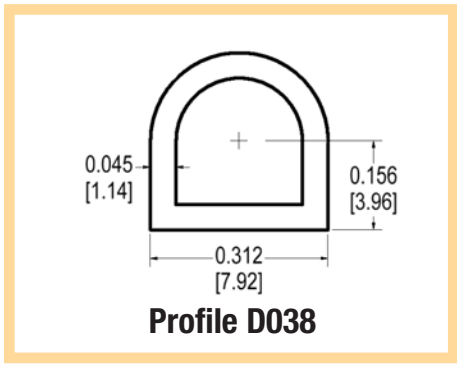
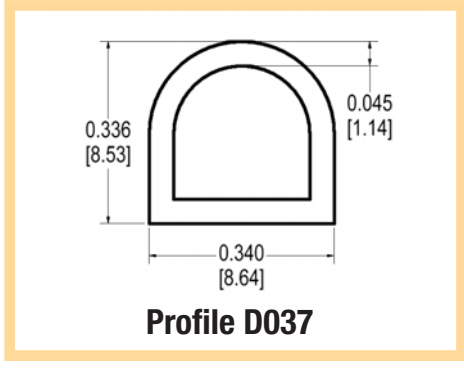
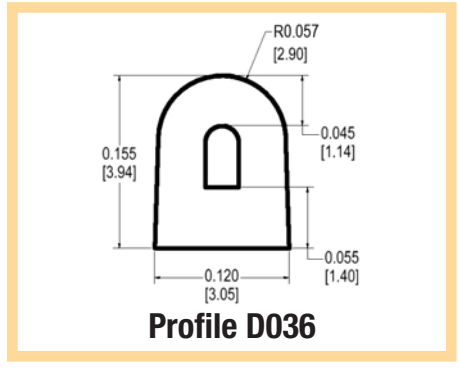
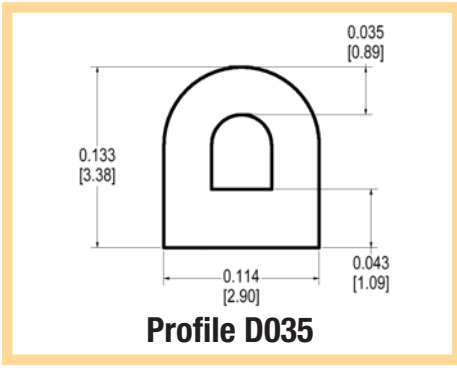
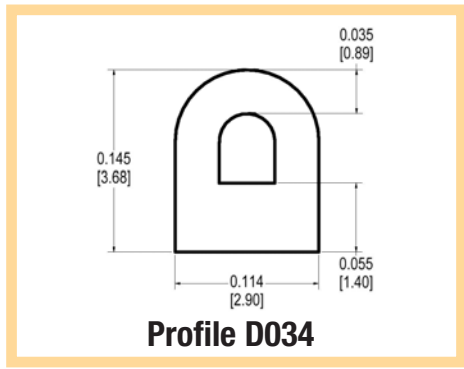
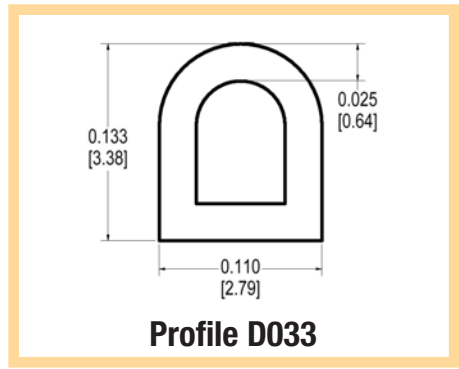
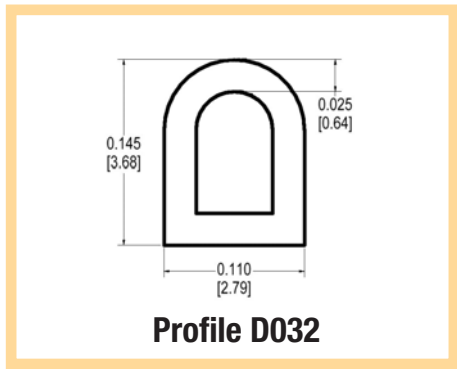
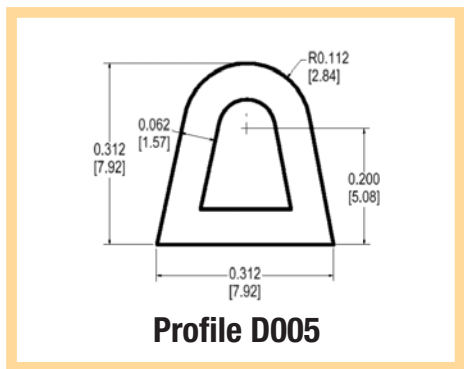
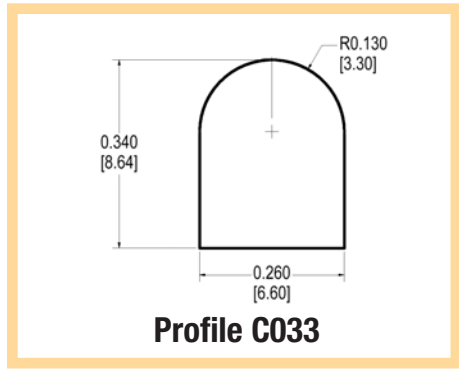
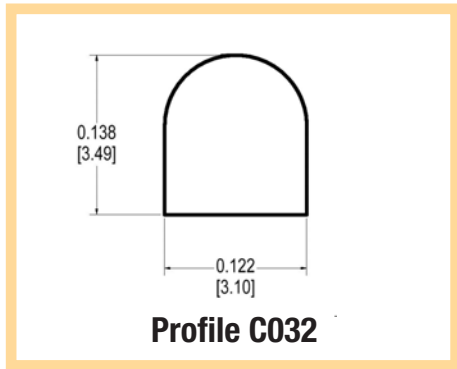

Custom Profiles Guide

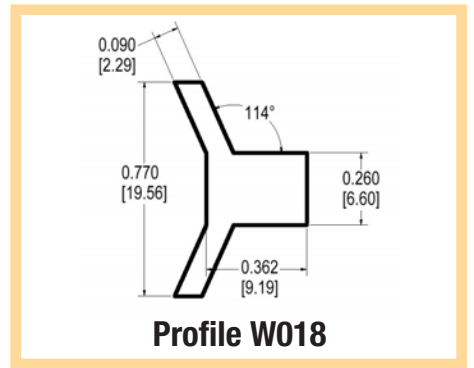
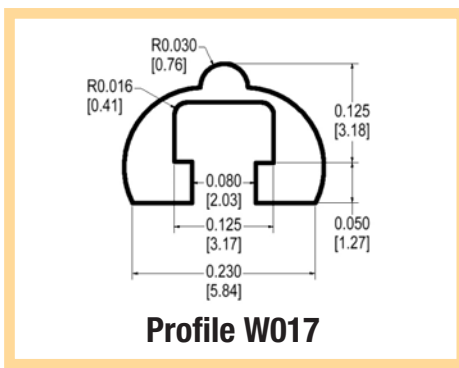
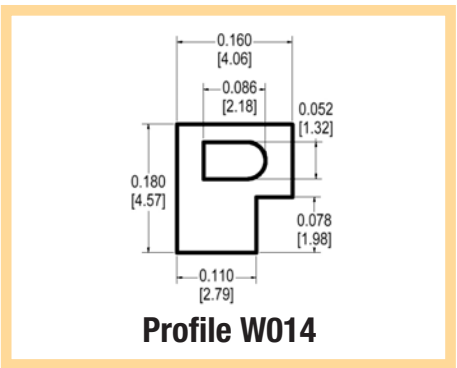
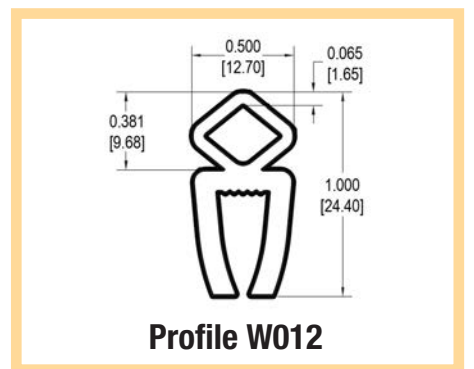
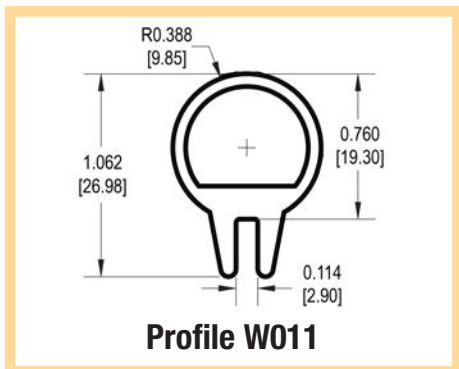
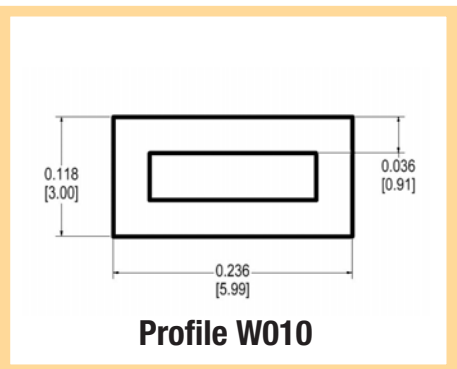
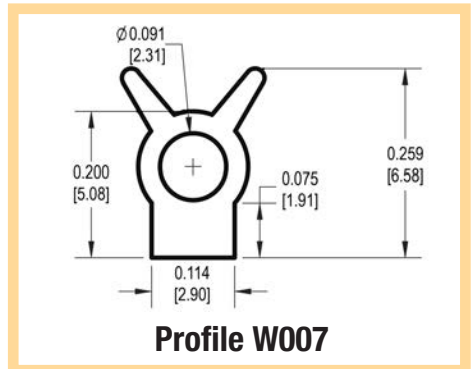
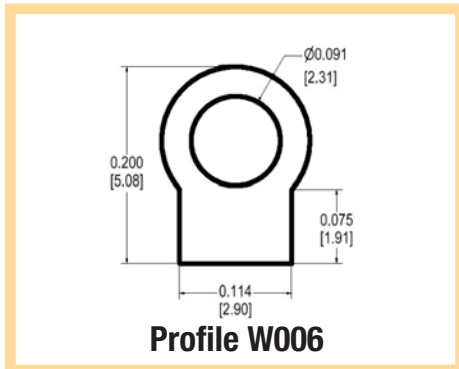
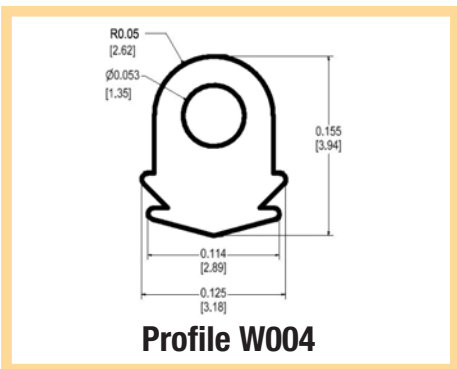
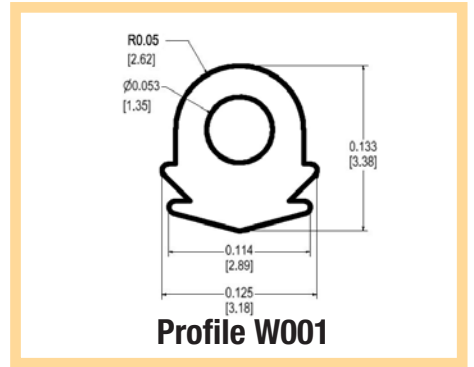
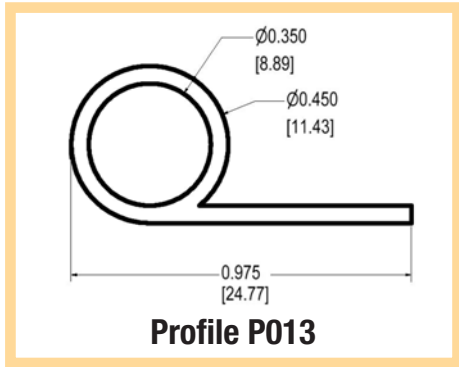
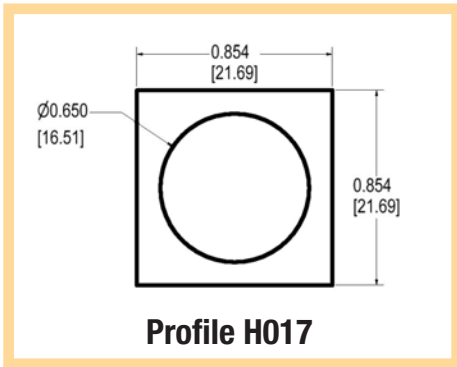

PROFILES

Custom Profiles Guide

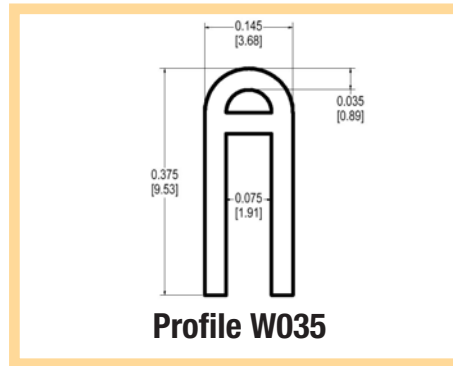
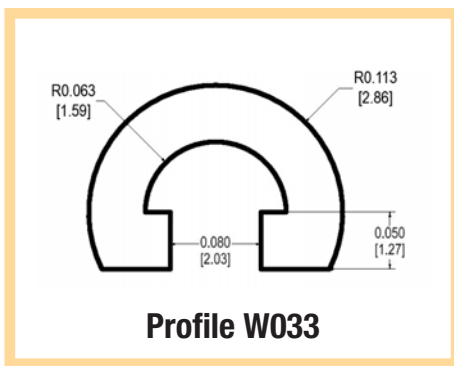
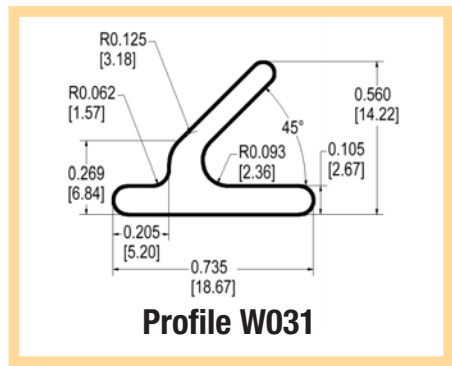
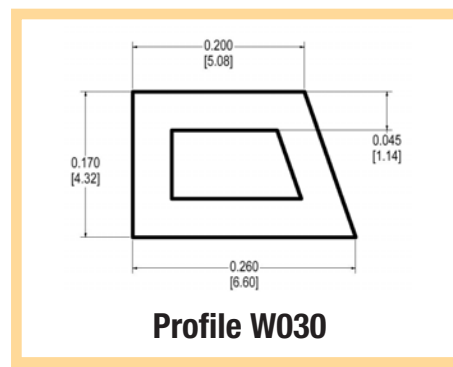
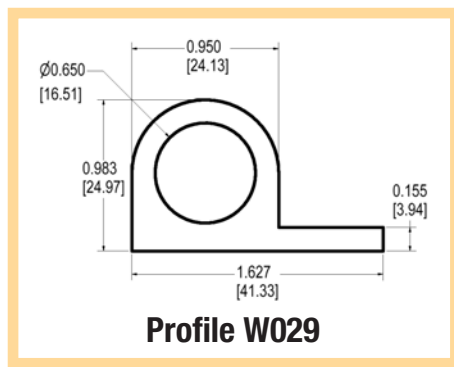
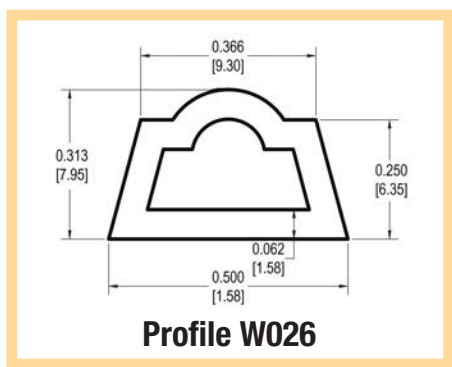
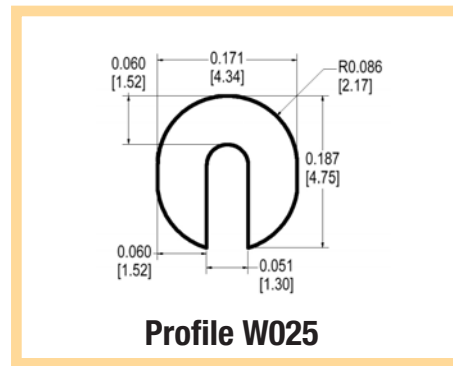
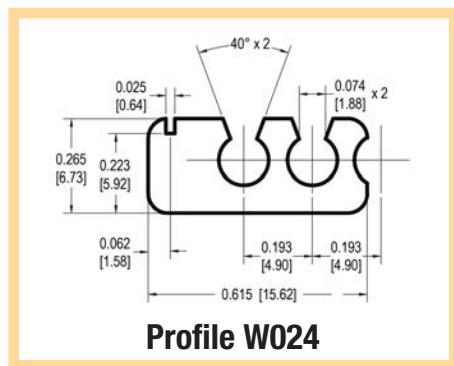
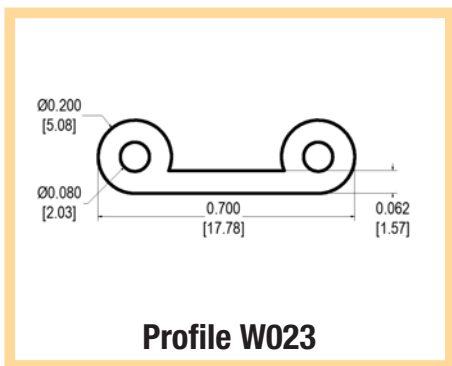
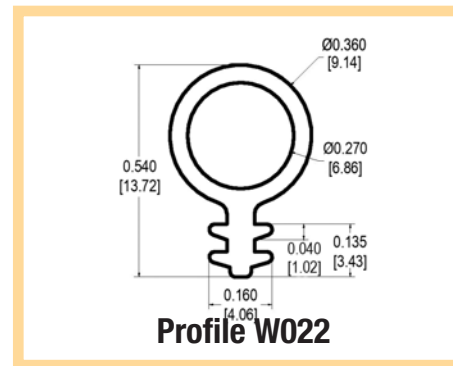
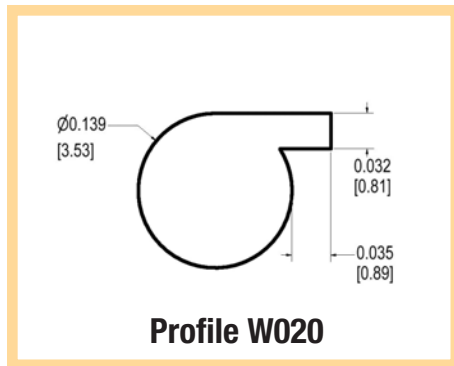
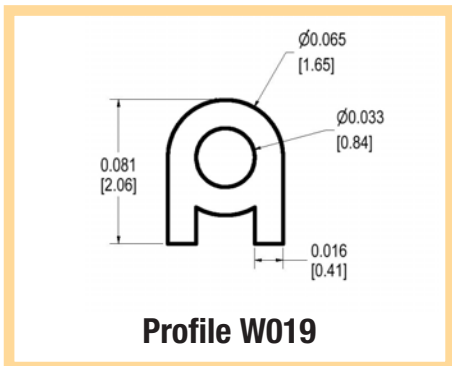

PROFILES

Custom Profiles Guide

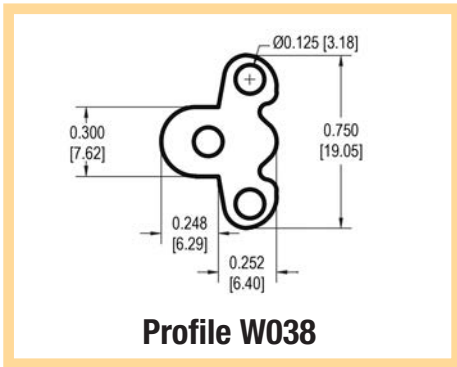

Profile W038

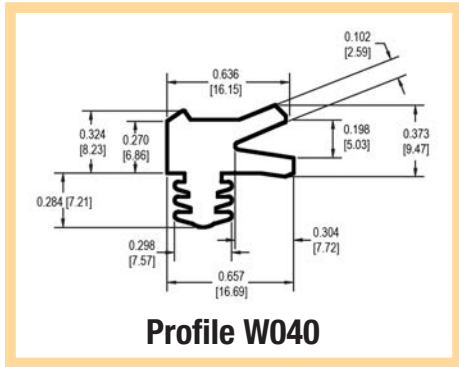

Profile W040

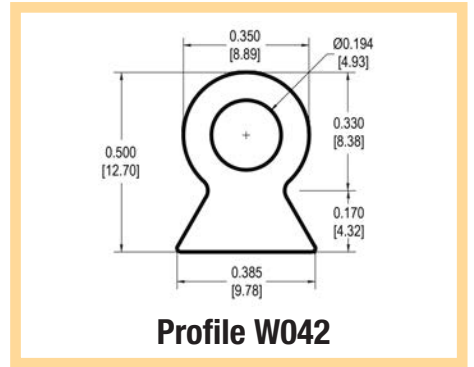

Profile W042

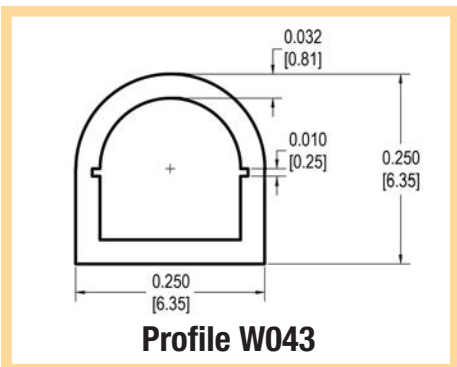

Profile W043

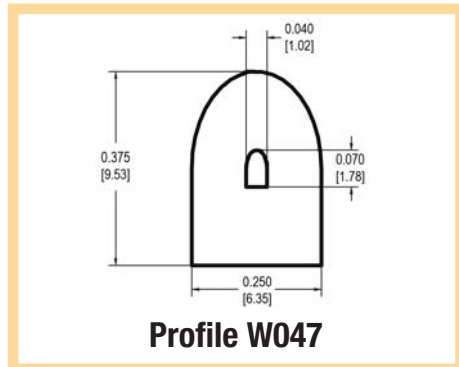

Profile W047

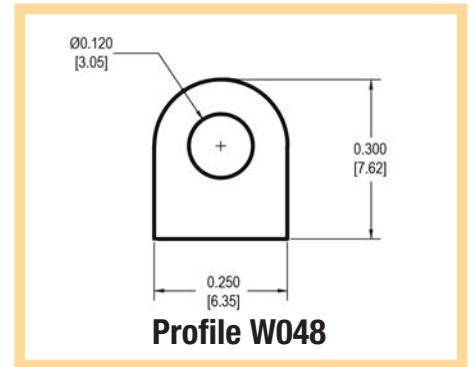

Profile W048

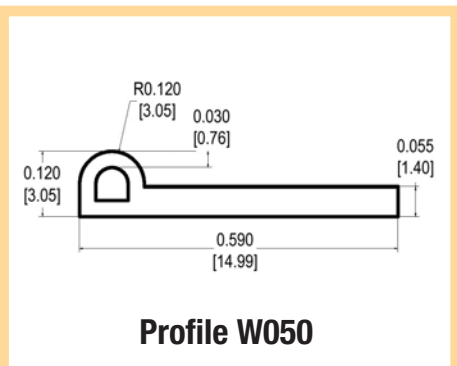

Profile W050

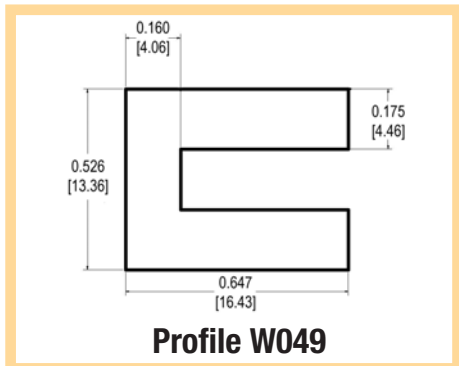

Profile W049

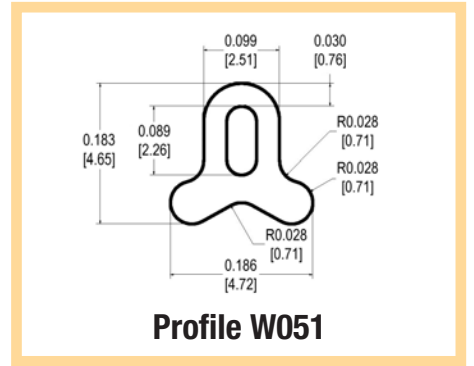

Profile W051

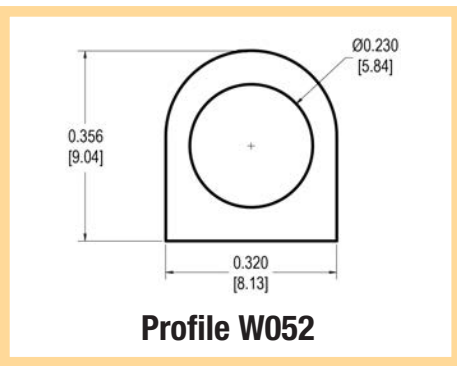

Profile W052

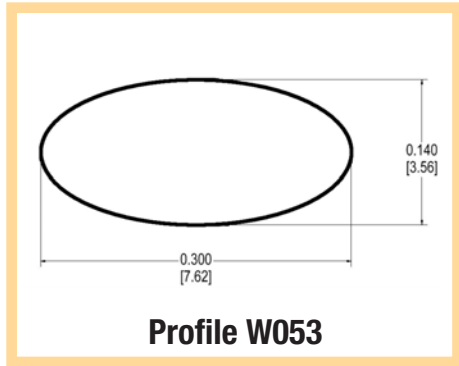

Profile W053

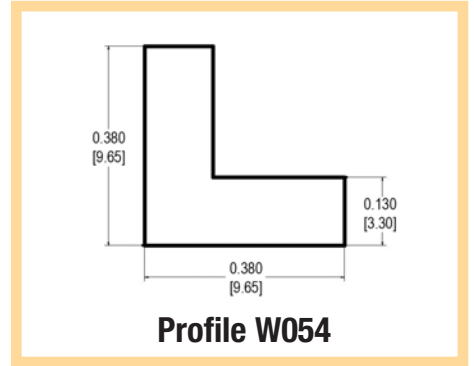

Profile W054

PROFILES

Custom Profiles Guide

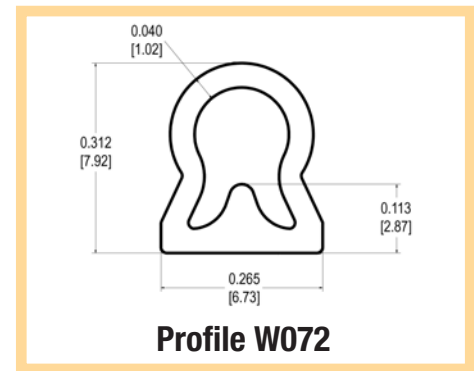
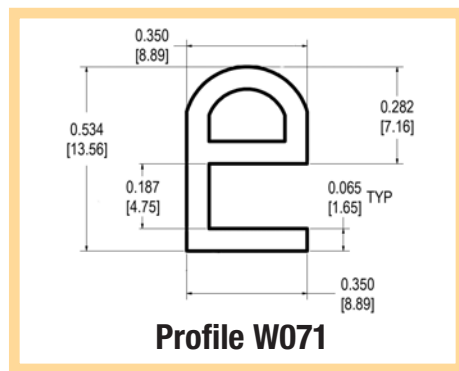
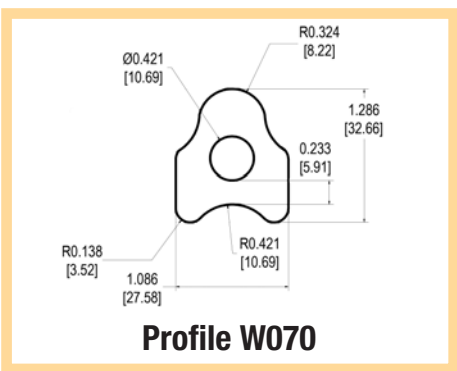
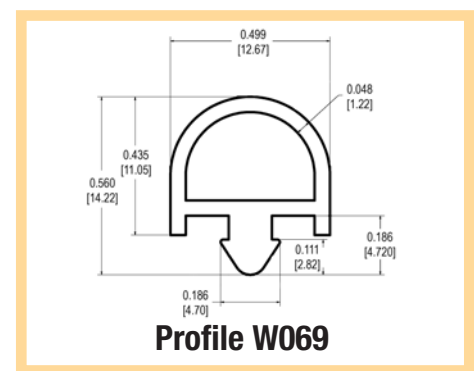
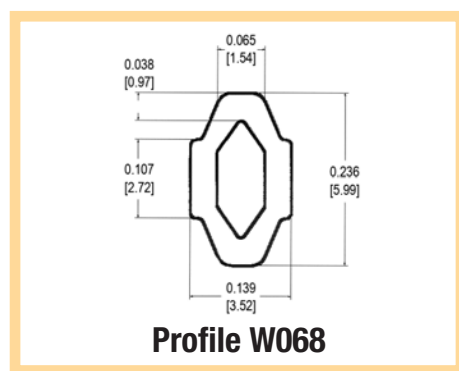
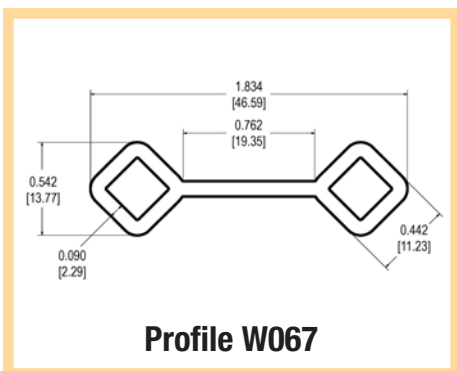
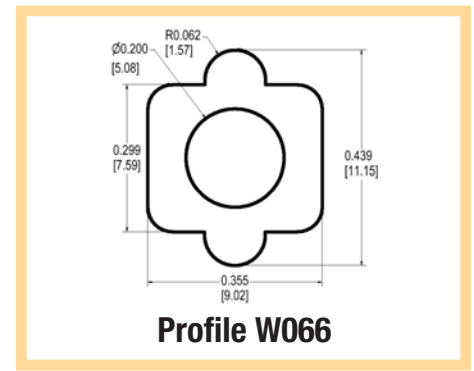
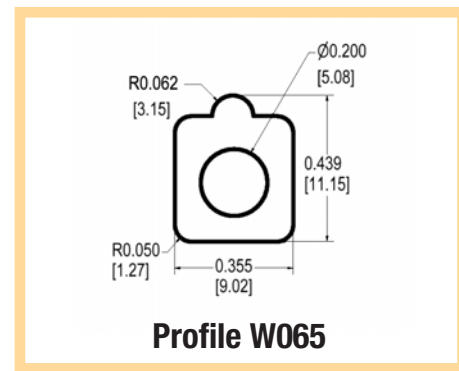
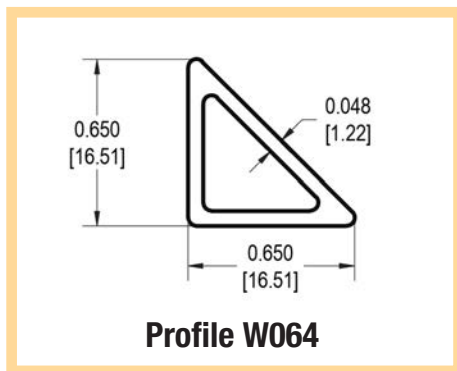
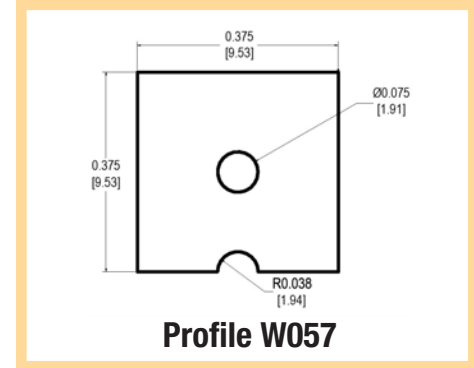
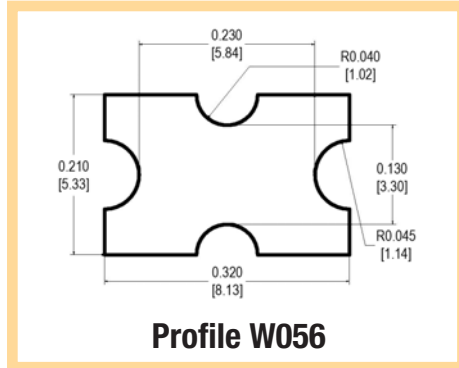
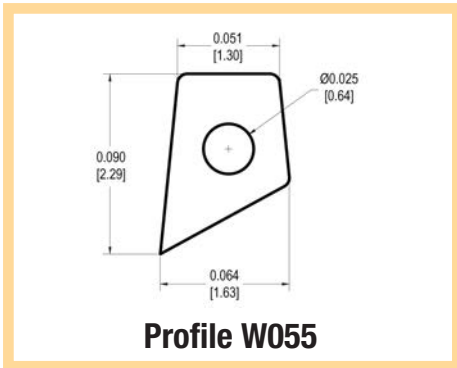

PROFILES

Custom Profiles Guide

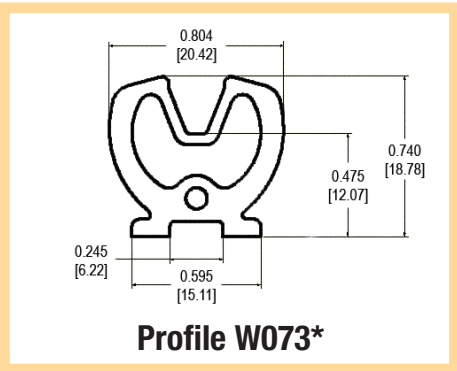

Profile W073*

*Patent pending

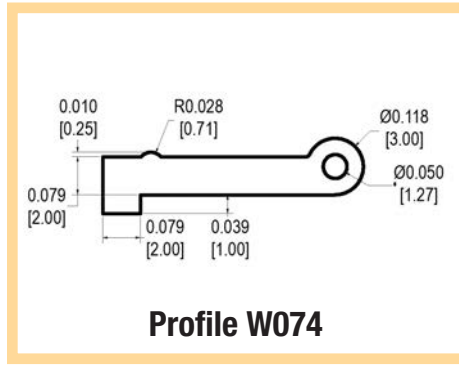

Profile W074

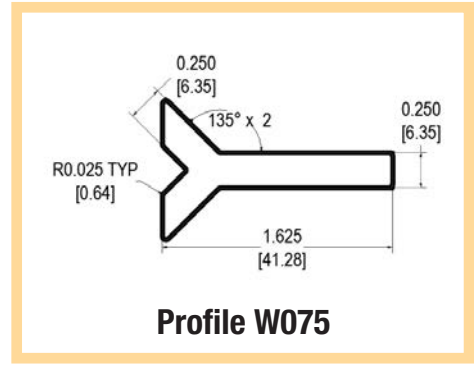

Profile W075

**...and many other custom configurations.
Together, we can turn an idea into reality.**

How to Specify a Standard TechSeal Part Number

Typical TechSeal Ten Digit Part Number

X XXX X XXXXX

- 1st digit - Profile configuration
- 2nd digit to 4th digit - Configuration size (see page 23 to 30)
- 5th digit: Description - Alpha #

| Alpha # | Description |
|---------|----------------------------|
| C | Coiled footage |
| P | PSA backing spool footage |
| Q | PSA backing coiled footage |
| S | Spoiled footage |
| X | Splicing and fabrication |
- 6th digit to 10th digit: Elastomer material

Example: A 001 S S7395

Part number A 001 S S7395 indicates a solid O profile with a cross section of 0.040 ± 0.003 inches [1.102 ± 0.08mm], supplied on spools and produced from TechSeal silicone compound S7395.

Custom profiles and configurations that have part numbers of XXXXX X (5 numbers and 1 letter) can be acquired by emailing tsdpricing@parker.com.

PROFILES

Appendix A - Compression / Deflection Charts

These charts are based on nominal conditions only. For the recommended compression range please see page 7 of this design guide or consult with TechSeal's team of Application Engineers.

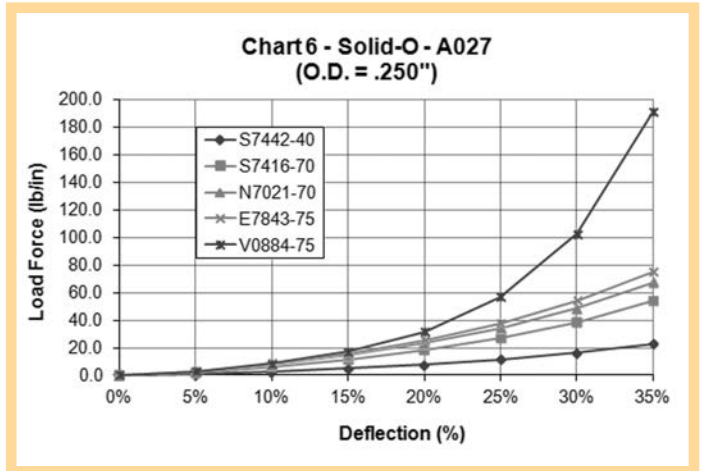
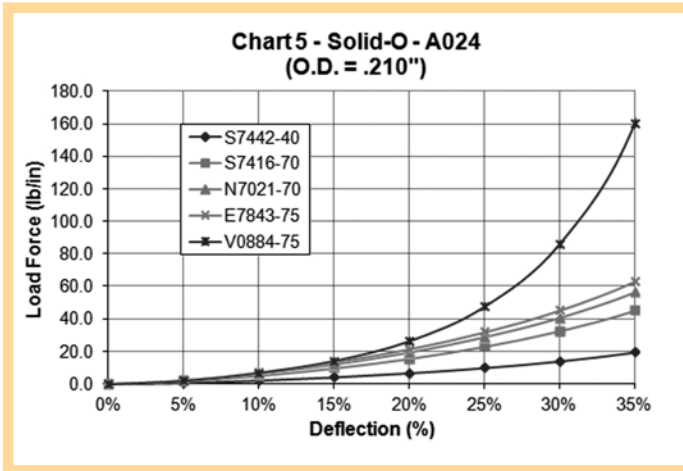
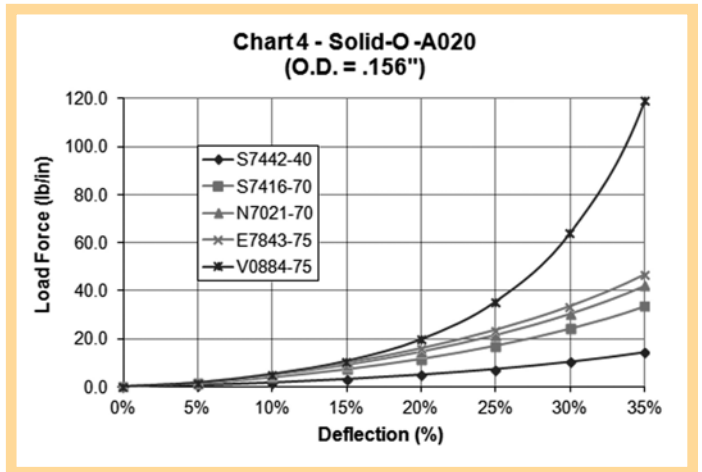
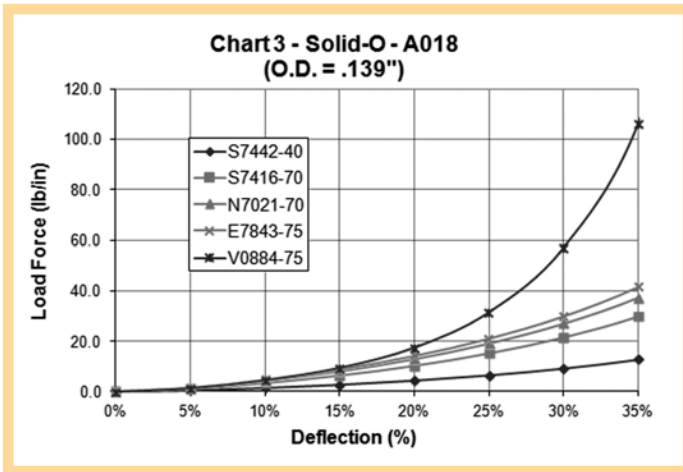
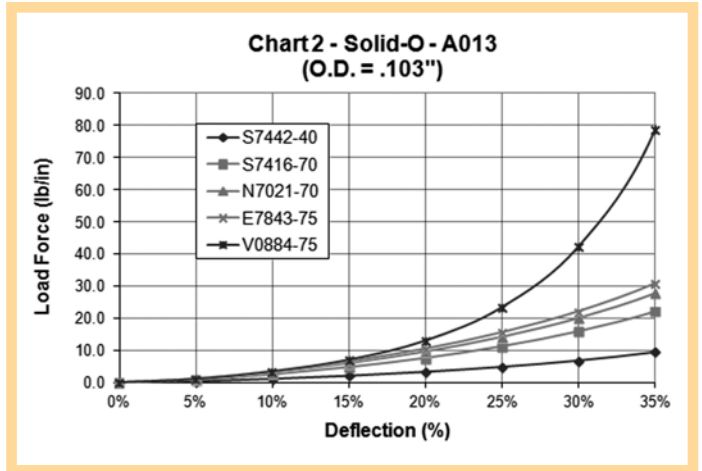
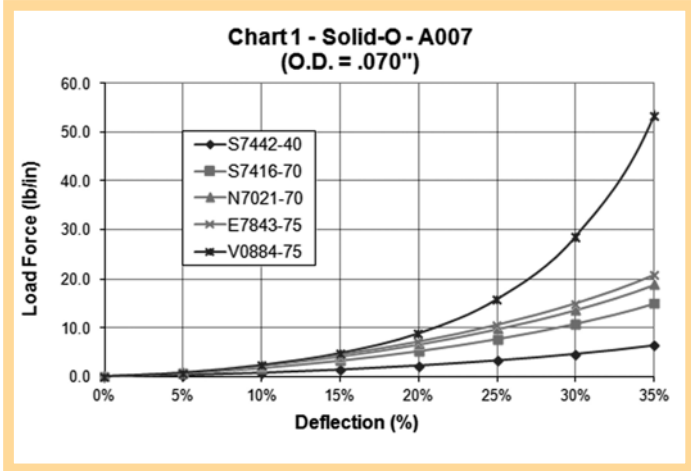

Appendix A - Compression / Deflection Charts

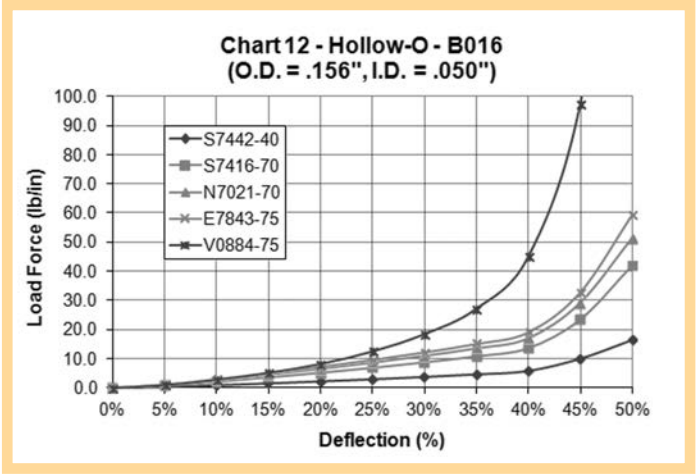
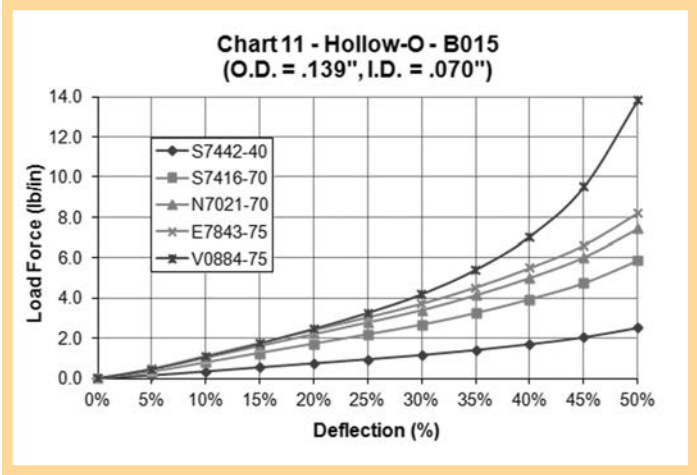
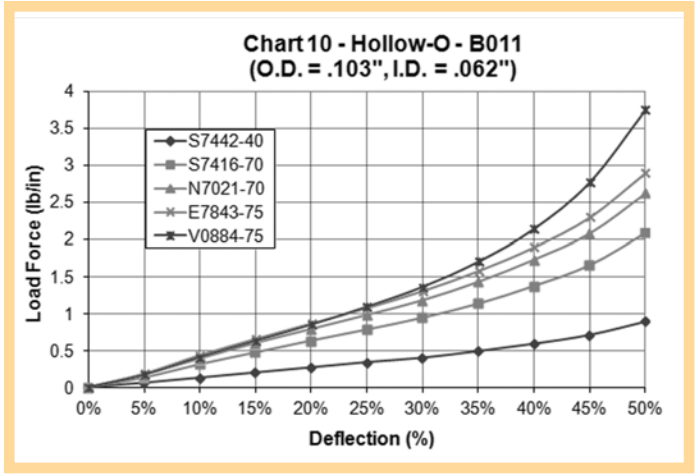
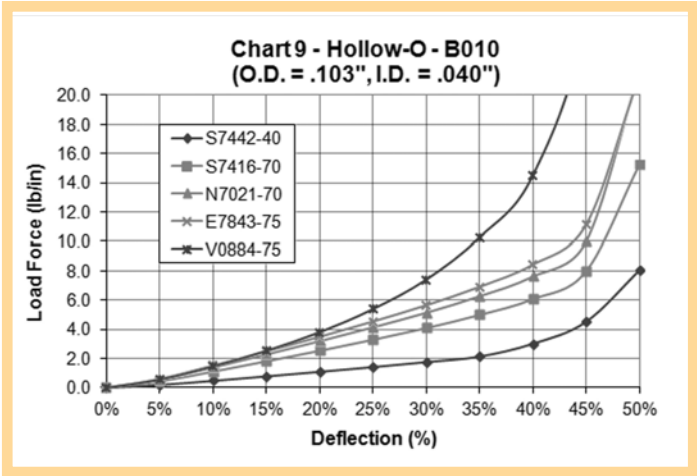
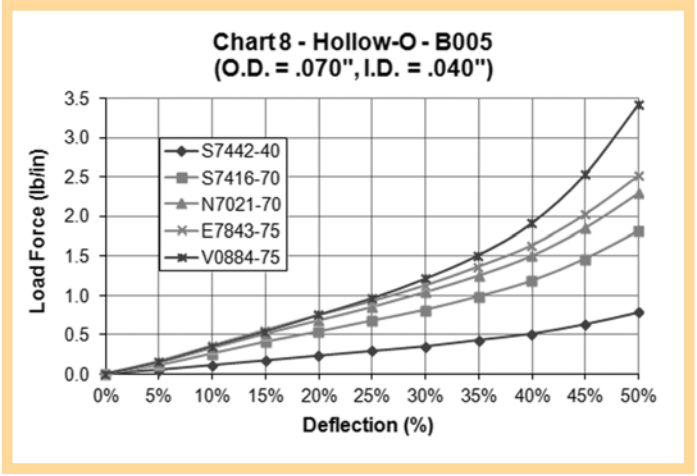
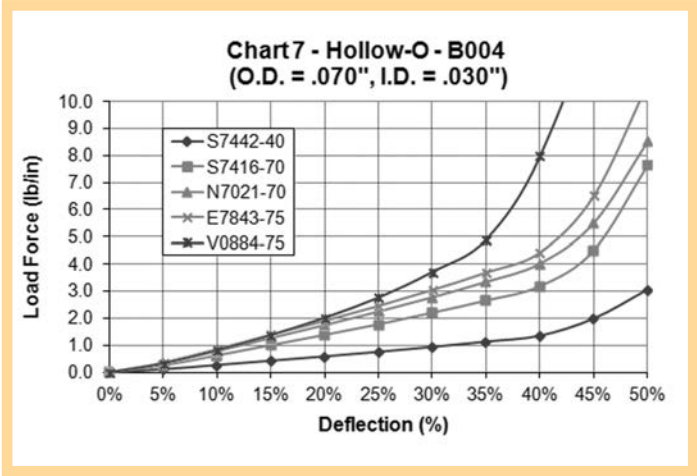

Appendix A - Compression / Deflection Charts

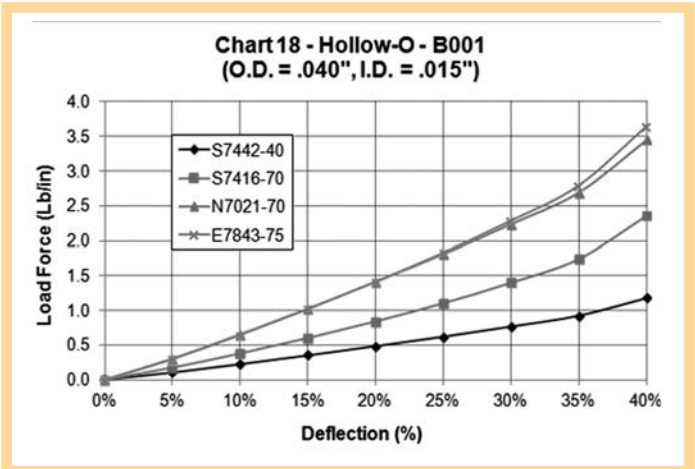
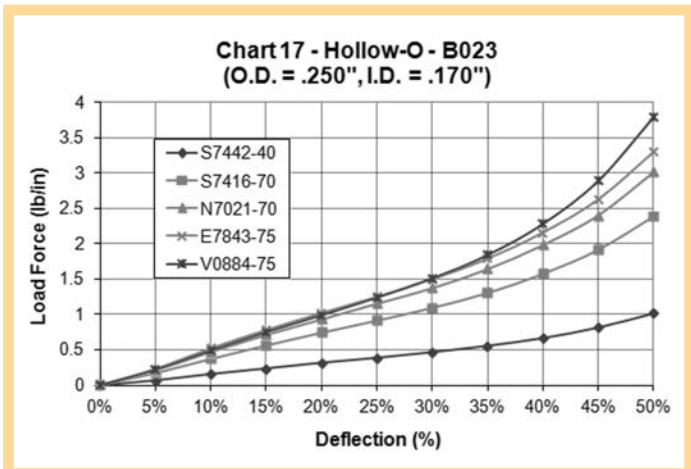
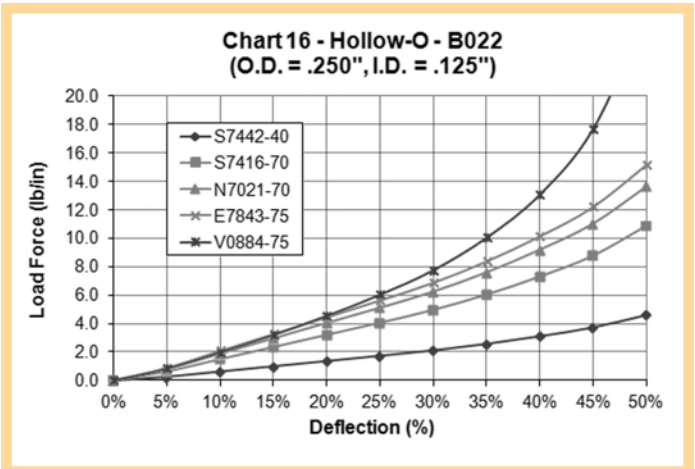
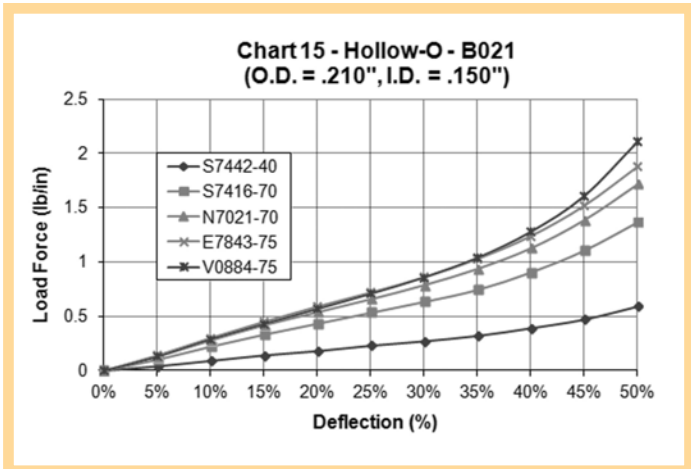
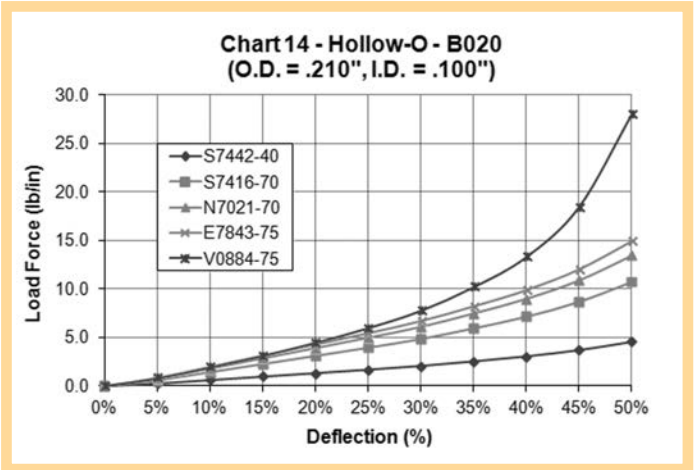
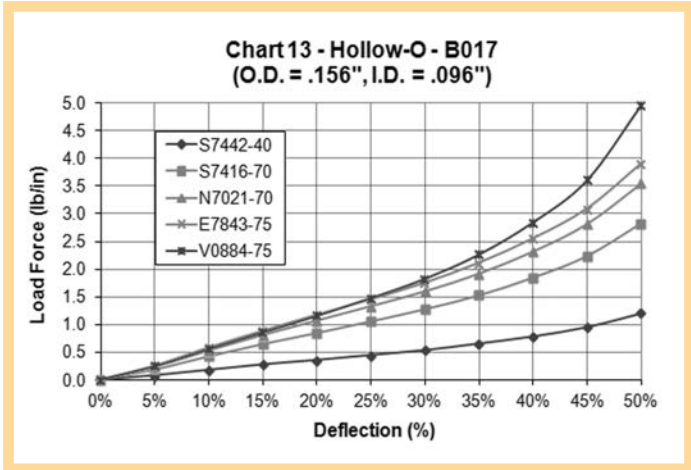

Appendix A - Compression / Deflection Charts

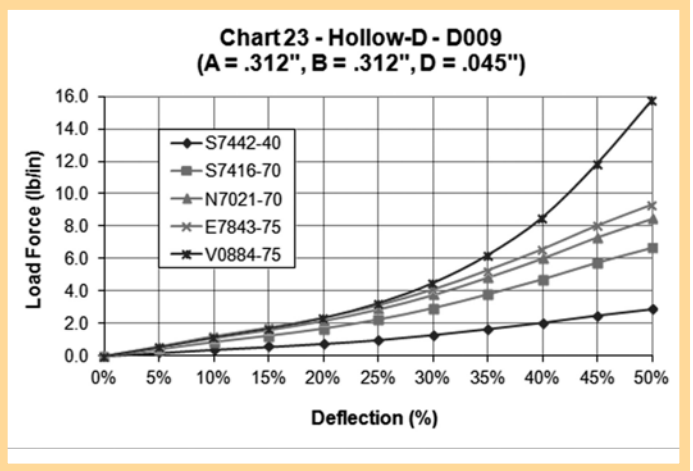
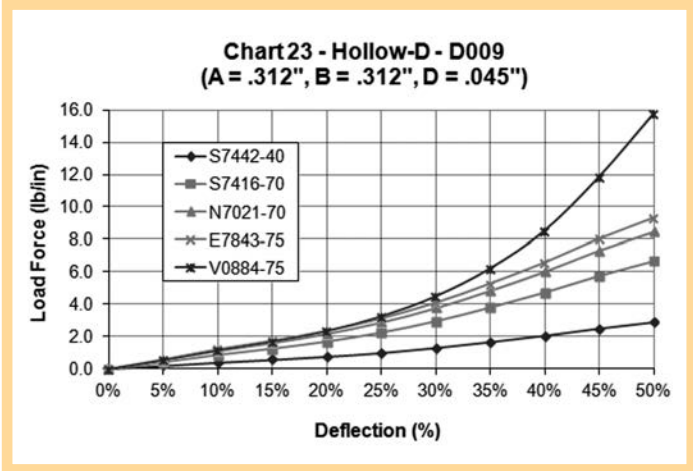
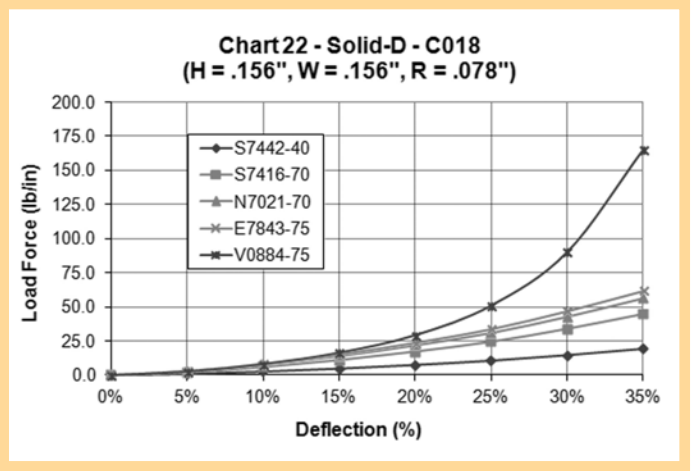
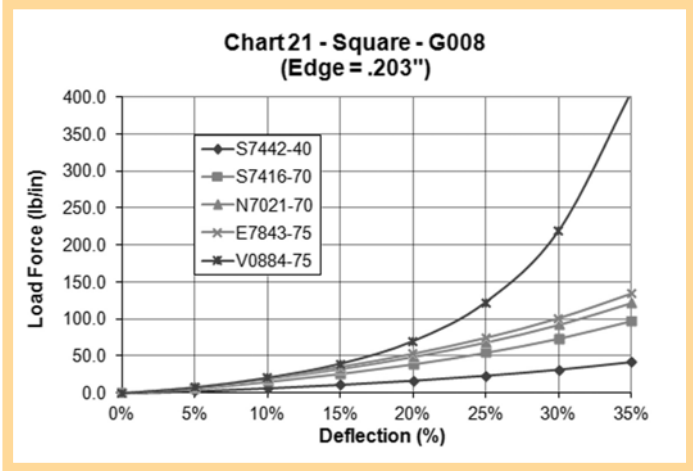
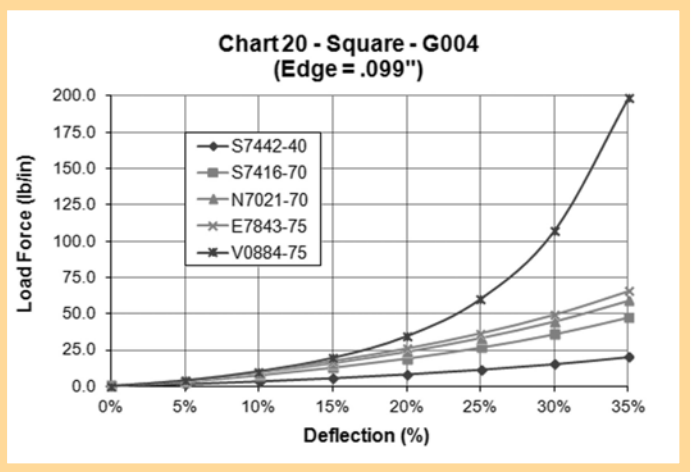
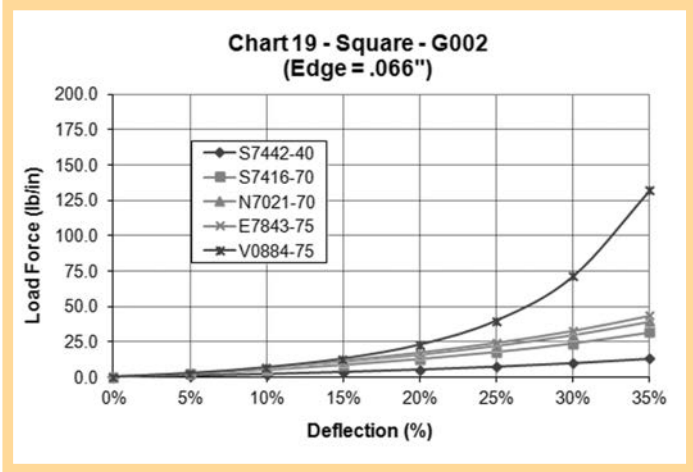

Appendix A - Compression / Deflection Charts

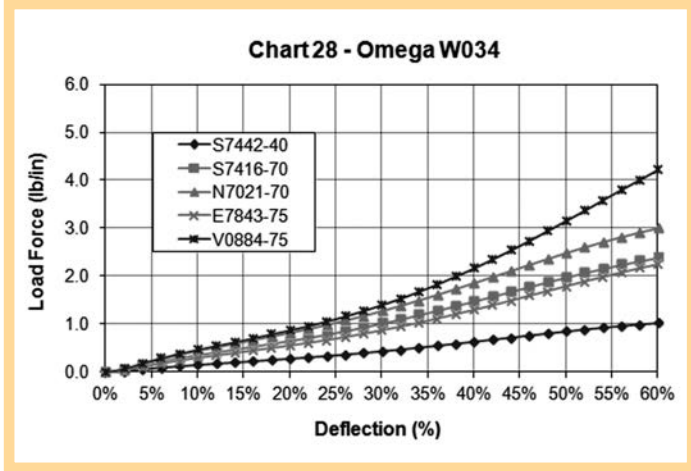
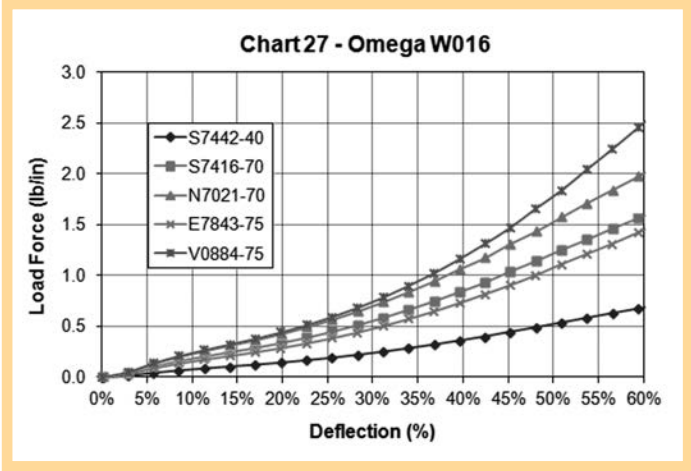
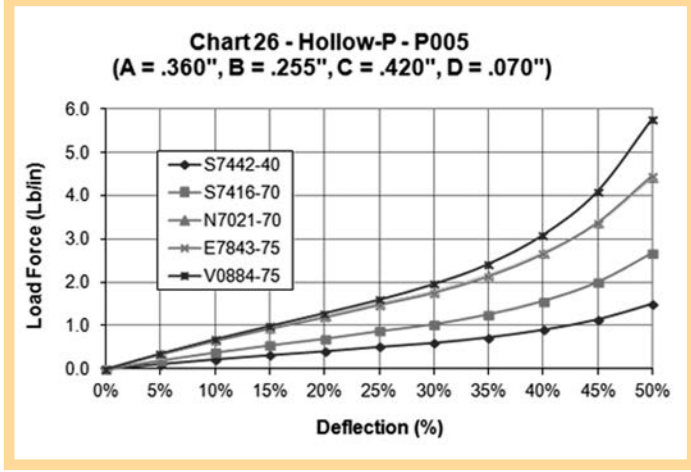
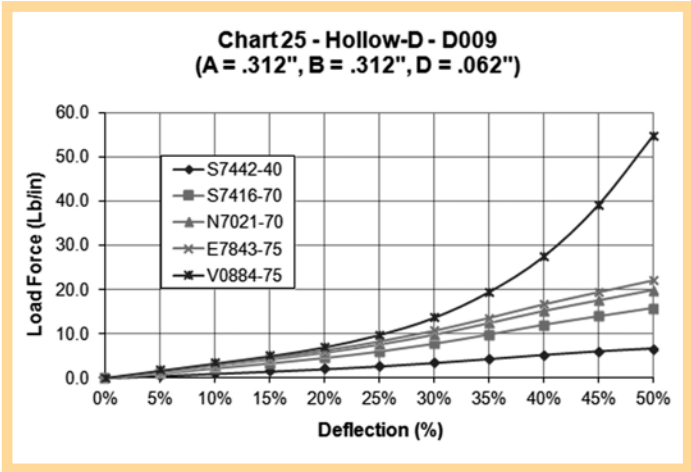

Appendix A - Compression / Deflection Charts

Friction-Fit Series

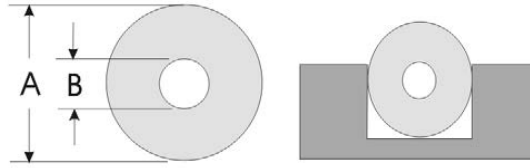

The maximum recommended compression force for the friction fit series is **28%**.
Please refer to page 25 for recommended grooves.

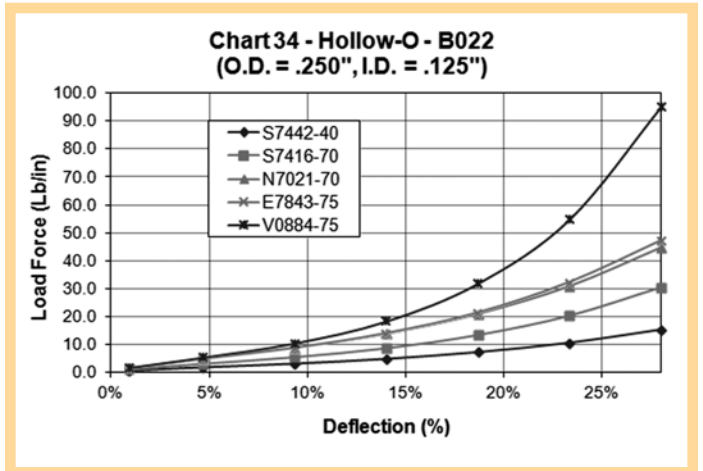
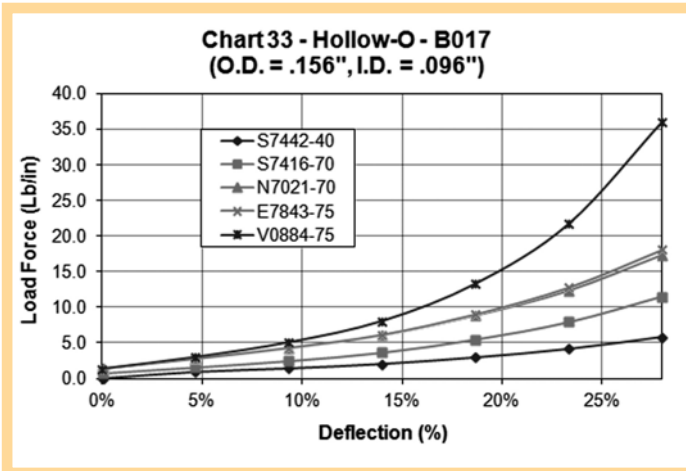
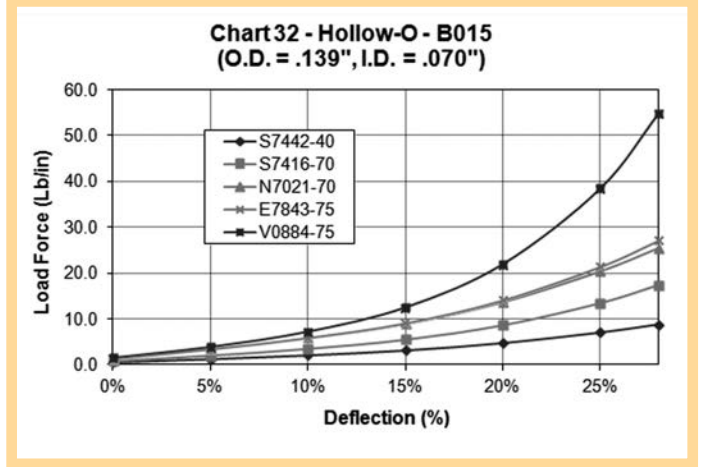
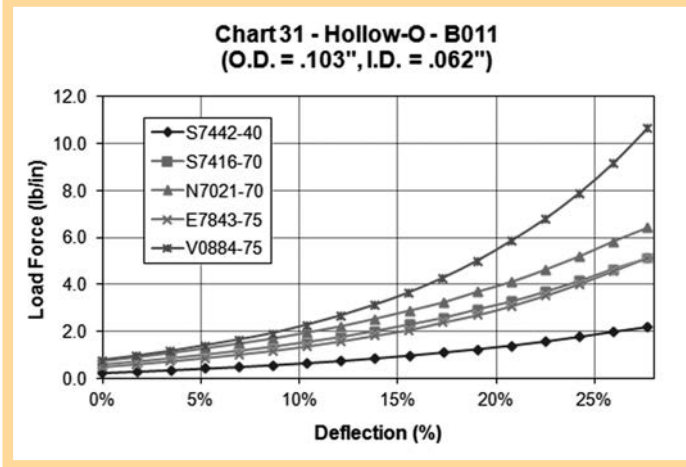
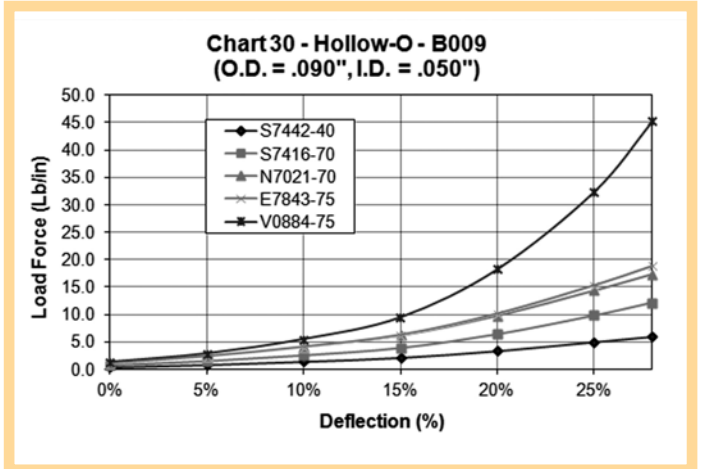
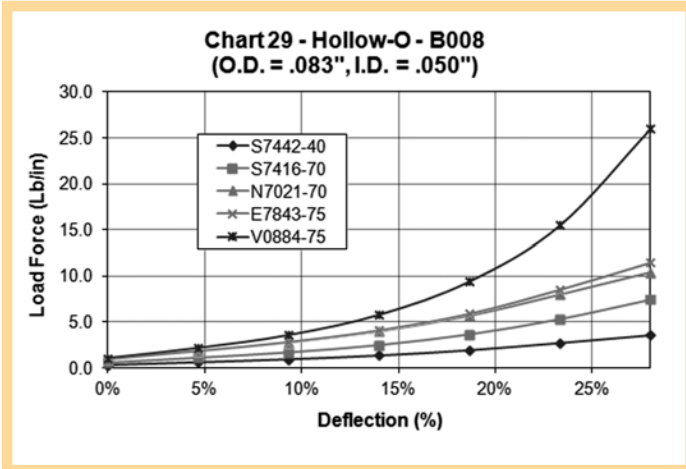

Appendix B - Physical & Chemical Characteristics

It is absolutely necessary to consider the important physical and chemical properties of seal elastomer formulations. This is needed to provide a clearer picture of how they fit together and enter into the selection process of the optimal seal compound. In this manual the term fluid is used to denote the substance contacting the seal. It may be a liquid, a gas, a vapor or a mixture. It shall apply to powders and solids as well.

Seal failures typically are due to use of an improper gland design, polymer selection or a combination of the two. There are significant differences between the physical properties of most synthetic elastomer polymer families, as well as differences between the properties of compound formulations within the same polymer family.

The physical and chemical properties a material typically exhibits will establish the best candidate for use in a particular application. The physical properties most commonly used when establishing the best synthetic elastomer formula candidate are as follows:

1. **Resistance to fluid medium**
2. **Hardness**
3. **Toughness or durability**
 - a). Tensile strength
 - b). Elongation
 - c). Compressive force
 - d). Modulus
 - e). Tear resistance
 - f). Abrasion resistance
4. **Volume change**
 - a). Swell
 - b). Shrinkage
5. **Compression set**
6. **Thermal effects**
7. **Resilience**
8. **Permeability**
9. **Corrosion**
10. **Deterioration**
11. **Coefficient of friction**
12. **Coefficient of thermal expansion**
13. **Compression stress relaxation**

1. Resistance to Fluid

The chemical effect of the fluid on the seal is of primary importance. The fluid must not alter the operational characteristics or reduce the life expectancy of the seal significantly, meaning that excessive deterioration of the seal must be avoided.

A significant amount of volume shrinkage usually results in a premature leakage of any seal. Conversely, a compound that swells excessively in a fluid, or develops a large increase or decrease in hardness, tensile strength, or elongation can continue to serve well for a long time as a static seal.

2. Hardness

Throughout the seal industry, the Shore A type durometer scale, manufactured by a variety of manufacturers, is the standard instrument used to measure the hardness of most rubber compounds. It should be noted that there are other hardness scales used to describe elastomers (B, C, D, DO, O, OO) but these are typically not used by the seal industry.

The durometer has a calibrated spring which forces an indenter point into the test specimen against the resistance of the rubber. There is an indicating scale on which the hardness is then read directly. It is calibrated to read 100 if there is no penetration, as on a flat glass or steel surface. (For specimens that are too thin or provide too small an area for accurate durometer readings, Micro Hardness Testing is recommended).

Softer materials, meaning those with lower hardness readings, will flow more easily into the microfine grooves of the mating part. This is significantly important in low pressure seals because they are not activated by fluid pressure. Conversely, the harder materials offer greater resistance to flow, and therefore are less likely to flow into the clearance gap beyond the groove.

In dynamic applications the hardness of a material has a major effect on friction. A harder material will typically have a lower coefficient of friction than a softer material; however, the actual running and breakout friction values are higher because the load required to squeeze the seal is greater.

Appendix B - Physical & Chemical Characteristics

For most applications compounds exhibiting nominal Type A durometer readings of 70 or 80 offer the best compromise. This is particularly true when dynamic forces or mechanics are involved in an application. Materials with durometer hardnesses of 90 or higher often allow a small amount of fluid to pass through with each cycle, while soft materials may have a tendency to abrade, wear and extrude.

Durometer hardness is typically established with a tolerance of ± 5 points, with the nominal or average hardness rounded off to the nearest 5 in increments of 5 or 10, such as 60 durometer, 75 durometer, etc. - not as 62 durometer or 71 durometer.

This is due to batch-to-batch variability of the formulation and variances encountered when using the durometer gages.

3. Tensile Strength

Tensile strength is the force per unit area, measured in pounds per square inch, obtained by stretching a standard test specimen of rubber until it ruptures. It is a production control measurement used to ensure uniformity of a compound, and can also be used to establish the deterioration of a material formulation after it has been in contact with a fluid for a long period of time.

This information is used as a tool to predict the life span of a given material in a specific environment. Tensile strength is not a proper indication of resistance to extrusion, and is typically not used in design calculations. In dynamic applications a minimum of 1,000 psi is normally required to assure adequate strength characteristics.

4. Elongation

Elongation is defined as a percent increase in length over the initial length of a seal. For establishing typical physical properties, it is usually expressed as ultimate elongation, which is the percent value attained when the test specimen breaks. This property primarily establishes the stretch that can be tolerated during the installation of a seal.

The smaller the seal, or the cross section of the seal, the more important the elongation properties. This value is also an indicator of the material and part dimensions combined effective ability to recover after installation stretch, peak overload, or localized source in one small area of a seal when considered with tensile strength. An adverse change in the elongation of a material after exposure to a fluid is a definite sign of degradation of the material. Elongation, like tensile strength, is used in the industry as a check for production batches of material.

It is recommended that standard test specimens be utilized when establishing a material's elongation properties in order to eliminate part specific variations that can occur due to geometric differences. Part specific profiles can be established but should not be used as specification limits.

5. Compressive Force

Compressive force is the force required to compress a seal cross section the proper amount to maintain an effective seal. This is especially important for applications that require low compressive loads.

Factors that have an effect on the amount of compressive force include the hardness of the material (durometer), cross section geometry (solid versus hollow), wall thickness if hollow, and amount of compression. Holding all factors constant, the compressive force will vary if the seals are made from two different compound formulations, even if material hardness is similar. The anticipated load for a given installation, then, is not fixed, but is a range of values. Increasing the temperature can soften elastomeric materials, yet the compressive force decreases very little except for the hardest compounds.

6. Modulus

As used in rubber terminology, modulus refers to the amount of stress at a predetermined elongation, usually 100%. It is expressed in pounds per square inch. The higher the modulus of a compound, the more apt it is to recover from peak overload or localized force and the better its resistance to extrusion. Modulus normally increases as the material durometer increases and is probably the best indicator of the toughness of a compound, all other factors being equal.

Appendix B - Physical & Chemical Characteristics

It is also used as a production control because it has a tendency to be much more consistent than tensile strength or elongation.

Modulus can also be used as a tool to predict seal life when combined with testing in heat, fluids, or a combination.

It is recommended that standard test specimens be utilized when establishing a material's modulus properties in order to eliminate part specific variations that can occur due to geometric differences. Part specific profiles can be established but should not be used as specification limits.

7. Tear Resistance

Tear strength is relatively low for most compounds. If it is below 100 lbs/in there is an increased danger of nicking or cutting the seal during the assembly process, especially if the seal must pass over sharp edges or burrs. Seal compounds with poor tear resistance will fail quickly under further flexing or stress once a crack is started.

Inferior tear strength of a compound is also indicative of poor abrasion resistance, which may lead to early failure of a material when used as a dynamic seal. Typically this does not need to be considered in static sealing applications.

8. Abrasion Resistance

Abrasion resistance is a general term used to describe the wear resistance of a compound. This terminology concerns rubbing or scraping of the seal's surface and therefore is important in dynamic sealing applications.

Only certain elastomers are recommended for use where moving parts actually contact the seal. Hollow cross sections typically are not used in dynamic applications, with the exception of container seals that are exposed to opening and closing of the two mating components, and can be defined as static seals after the assembly is closed.

Higher durometer compounds, up to 85 durometer, are typically more resistant to abrasion than softer compounds.

9. Volume Change

Volume change is measured as a percent (%) and is the increase or decrease in elastomer volume after it has been in contact with a fluid when compared to the original seal sample volume.

a. Swell:

Swell, or an increase in volume, is almost always accompanied by a decrease in hardness. Excessive swelling will result in a marked softening of the rubber, which will lead to reduced abrasion and tear resistance, and may permit extrusion of the seal into adjacent gap areas under high pressure. For static applications volume swell up to 50% may be tolerated, providing that provisions are made to the gland design to prevent stress to the assembly. For dynamic applications, swell of 15 to 20% is a typical maximum unless provisions are made to the gland design.

Material swell can supplement a seal's effectiveness under certain circumstances. Swell may offset compression set. An example, is as a seal relaxes 15% and swells 20%, the relaxation (compression set) tends to be cancelled by the swell.

Absorbed fluid may have a similar effect on a compound as does the addition of plasticizers, providing additional flexibility at the low end temperature of its operation range. These effects should not be relied upon when selecting a compound for an application, however they can contribute to seal performance.

The amount of swell that a material exhibits after long term fluid exposure – stabilized volume – is seldom reported because it may take a month or more at elevated temperatures to attain. On occasion the usual 70 hour immersion test will indicate a swelling effect, whereas a long term test shows shrinkage. Therefore swell characteristics indicated by short term testing may only be an interim condition.

Appendix B - Physical & Chemical Characteristics

b. Shrinkage:

Shrinkage, or a decrease in volume, is almost always accompanied by an increase in hardness. As swell compensates for compression set, shrinkage intensifies compression set, causing the seal to pull away from the sealing surfaces and creating a leak path. Therefore, shrinkage is far more critical than swell. More than 3 or 4% shrinkage can be serious for moving seals. The fluids present may extract plasticizers from the material that causes the seal to shrink when the fluid is temporarily removed.

This type of shrinkage may or may not be serious, depending on magnitude, gland design and degree of leakage tolerable before the seal re-swells. Even if the seal re-swells there is the possibility that it will not properly re-seat itself. If any shrinkage is a possibility in an application, it must be considered thoroughly and carefully.

10. Compression Set

Compression set is generally determined in air, and is reported as the percent deflection by which an elastomer formulation fails to recover to its original size, after a fixed time under a specified squeeze and temperature. As an example, 0% would indicate that no relaxation has occurred, while a value of 100% would indicate that total relaxation has occurred.

Even though it is desirable to have a low compression set, this condition may not be critical from a design standpoint because of actual service variables. A good balance of all physical properties is typically necessary to optimize sealing performance.

As an example, a seal can continue to function after taking a compression set of 100% providing the temperature and system pressure remain constant and no motion or force causes the seal line of contact to break. As previously mentioned, swelling caused by service fluid exposure may compensate for compression set.

The condition to be feared the most is a combined effect of compression set and shrinkage. This will lead to seal failure unless exceptionally high squeeze is used in the application.

If the seal profile being utilized in an application is hollow, increasing the O.D. of the seal can reduce compression set. This can also be combined with an increase in the I.D. of the seal to avoid creating an overfill condition with the seal gland.

By increasing the diameter(s), an increase in squeeze is being created which can offset the actual compression set characteristics noted for the application. The actual percent compression set realized may be comparable, however the true distance the seal is being compressed is larger, effectively increasing the displacement distance and increasing (possibly) the deflection force required.

11. Thermal Effects

All rubber is subject to deterioration at high temperature. The volume change and compression set properties are both greatly influenced by heat. Hardness is influenced in several ways. An increase in temperature can soften the material, which is a physical change, and this condition will reverse when the temperature goes back down. This effect must be considered in high pressure applications, because a compound that resists extrusion at room temperature may begin to flow through the clearance gap as the temperature rises.

Over time with exposure to high temperatures chemical changes begin to occur to the material. These typically cause an increase in hardness, along with volume and compression set changes as previously mentioned. Changes in tensile and modulus properties can also occur. Since these are chemical changes, they are not reversible.

Changes caused due to exposure to low temperatures are usually physical and reversible. An elastomer will almost totally regain its original physical properties when warmed.

Several tests are available to define the low temperature characteristics of a material, the most common of which is the military modified version of TR-10 or Temperature Retraction. The TR-10 results are easily reproducible. For this reason this type of testing is used to assure low temperature performance and on occasion as a production consistency check.

Appendix B - Physical & Chemical Characteristics

Most compounds will provide effective sealing at 15°F [-9°C] below their TR-10 temperature values. If low pressures are expected in an application at low temperatures, hardness should be considered along with the low temperature properties of the material. As temperature decreases, hardness increases.

Low pressures require a soft material that can be deformed easily into or against the mating surfaces. Hollow profiles using harder durometer compounds can also generate this same type of effect, with the addition of the higher tensile and modulus properties these harder materials typically exhibit.

Hardness is only one of several criteria to consider when low temperature sealing performance is involved. Flexibility, resilience, compression set, and brittleness can serve as more basic criteria for sealing at low temperature.

Durometer measurements alone are not reliable indicators of low temperature sealing performance. The swelling or shrinkage effect of the fluid being sealed must also be taken into account. If the seal swells, it is absorbing fluids, which may act in much the same way as a low temperature plasticizer: it will allow the seal to be more flexible at lower temperatures than it would without the fluid exposure.

If the seal shrinks, something is being extracted from the compound. This is typically the plasticizer provided for low temperature flexibility. As a result, the seal may lose some of its ability to flex at low temperatures.

Crystallization, or the re-orientation of molecular segments causing a change of properties in the compound, is one side effect of low temperature exposure that must be considered, especially in applications where dynamics are involved. When this happens, the seal has no resiliency and becomes rigid.

This condition usually shows up as a flat spot on the seal surface, and it can be confused with compression set. When the seal is warmed, the flatness will gradually disappear and the seal will regain its resilience. It may take several months for a seal to initially crystallize at low or moderate temperatures, however on succeeding exposures crystallization sets in much more rapidly. The end result of crystallization is seal leakage.

12. Resilience

Resilience is the ability of a material to return quickly to its original shape after temporary deflection. This is primarily an inherent property of the elastomer. It can be improved, somewhat, by compounding.

More importantly, poor compounding techniques can destroy it. Sealing capability depends on good resiliency to optimize performance, such as hollow environmental cabinet seals or two-part hinged containers. This is established by choosing the proper combination of elastomer and geometry for each sealing application.

13. Permeability

Permeability is the tendency of a gas to pass or diffuse through the elastomer. This should not be confused with leakage, which is the tendency of a fluid to go around a seal. Permeability is of prime importance in vacuum service and a few pneumatic applications involving extended storage.

Three basic rules apply: Permeability increases as temperatures rise. Different gasses have different permeability rates. The more a seal is compressed, the greater its resistance to permeability.

Most materials used in vacuum applications are typically exposed to additional (post) cure to drive off any residual water or volatiles in the compound. This reduces the possibility of outgassing, which in turn can cause serious degradation of the system being sealed.

14. Corrosion

Corrosion is the result of chemical action of a fluid and / or the compound on the metal surface of the seal gland. Fluid corrosion of the metal gland will cause a change of finish that can vitally effect the seal.

When rubber seals were first being used, there were many instances where the compound did adversely effect the metal gland causing pitting on the surface. Specific elastomer compounding ingredients, like uncombined sulfur, were found to cause the problem.

Appendix B - Physical & Chemical Characteristics

Current day compounding and ingredient technologies have made reports of corrosion rare. However, as new compounding ingredient technology is introduced continuous attention to corrosive effects is necessary.

15. Deterioration

This term typically refers to a chemical change in the elastomer that results in a permanent loss of properties. It is not to be confused with reversible or temporary property losses. Both permanent and temporary property losses can be accompanied by swell. The temporary condition is due to physical permeation of the fluid without chemical alteration.

16. Coefficient of Friction

Coefficient of friction of a moving rubber seal relates to hardness, lubrication and the surface characteristics of the surrounding materials. Typically, static friction is many times greater than kinetic friction, but this can vary with the hardness of the material.

Usually an increase in compound hardness will increase static friction while a decrease in hardness lowers static friction.

17. Coefficient of Thermal Expansion

Coefficient of linear expansion is the ratio of the change in length per °F to the length at 0°F. The coefficient of volumetric expansion for a solid is roughly three times the linear coefficient. Elastomers typically exhibit a coefficient of expansion ten times that of steel. This characteristic can be a critical factor at high temperatures if the gland is nearly filled with the seal or at low temperatures if the squeeze is minimal.

Reactions can take place that can cause a seal to generate relatively high forces against the sides of a seal groove. These forces are generated by thermal expansion of the rubber and / or the swelling effect of a fluid.

If the seal is completely confined and the gland is 100% filled, the dominating force is the force of thermal expansion. Force applied by the seal due to the effects of fluid swell is very minor if the gland volume exceeds the seal volume by 5 to 10%.

It is recommended that in no case should the gland fill percentage exceed 95%.

18. Compression Stress Relaxation

Throughout the rubber industry, compression set testing has been established as the primary methodology used to establish a seal material's ability to seal over time. Another method that can be utilized is compression stress relaxation or CSR. This measures the change in resistant force (decrease) over time that a material exhibits when exposed to a constant compressive force (typically 25%).

This methodology provides a measure of initial force displacement and retention over time, which can be used as a tool to predict a material's long term sealing ability.

Appendix C - Standard Test Procedures

There are standard ASTM procedures for conducting tests on rubber materials. These procedures must be followed carefully and properly if consistent test results are to be generated.

Aging

Deterioration over time, or aging, relates to the nature of the rubber molecule itself: long chain-like structures (polymers) composed of many smaller molecules (monomers) joined together. The points where the individual molecules are joined together are called bond sites. Bond sites and other areas may be susceptible to chemical reaction, of which three basic types are associated with aging:

1. Scission:

The molecular bonds are cut, dividing the chains into smaller fragments. Ozone, ultraviolet light and radiation exposure are typical causes.

2. Cross-Linking:

An oxidation process whereby additional intermolecular bonds are formed, usually caused by heat and oxygen exposure.

3. Modification of Side Groups:

A change in the complex, weaker fringe areas of the molecular construction due to chemical reaction. Moisture is an example of a cause contributor. All mechanisms by which rubber deteriorates are due to the environment and exposure.

All mechanisms by which rubber deteriorates are due to the environmental and exposure. Therefore it is the environment, not age, that impacts seal life, in both storage and actual service.

Environmental Change

High humidity in air will reduce the tensile properties of some materials. Changes to a fluid can occur in service due to the effect of heat and / or contaminants that can cause a rubber material to react differently than when exposed to new fluid. For this reason tests are sometimes conducted in used fluid, to essentially duplicate the environment the seal will be exposed to in actual service.

Storage

Storage, or shelf life, can vary with the resistance of each synthetic elastomer to normal storage conditions as well as the method of packaging. Consult the TechSeal Division for specific information on storage and shelf life of individual elastomer materials. The ideal elastomer product storage environment would provide:

- Ambient temperatures not exceeding 120°F [49°C]
- Exclusion of air (oxygen)
- Exclusion of contamination
- Exclusion of light (especially sunlight)
- Exclusion of ozone
- Exclusion of radiation
- Exclusion of moisture

Test Specimens

ASTM test procedures include descriptions of the standard specimen sizes needed for each test.

Part geometry can play a very large role in establishing physical properties variation. As an example, in fluid immersion tests smaller cross section seals can swell more than larger cross section seals. Using direct property readings from hollow cross section seals is not recommended. While it is possible to establish a performance envelope that is part specific, tolerance stack-ups, normal batch-to-batch variation and cross-sectional geometry can provide a wide fluctuation in test results. This effect can be realized even when comparing the part-specific properties of two different profiles of the same configuration (i.e., hollow round) that are produced from the same lot of material.

It is recommended that if test data is required and / or if samples of the cured material are required for user evaluation that standard ASTM test specimens be utilized.

Appendix D - Glossary of Material Properties

Aged Physical Properties

It is absolutely necessary to determine the resistance of the seal in the application when exposed to the actual service environment. The initial material performance characteristics can be established by measuring the change in volume and physical properties of the candidate material, using test specimens, after exposure to various conditions for specific times and temperatures (i.e., 70 hours @ 212°F [100°C]).

Recommended times, temperatures and test fluids can be found in ASTM Method D471. It is suggested that the actual service fluid be used whenever possible. Bear in mind that fluid variation can account for differences in test results.

Compression Set

Typically reported as the amount that a material fails to recover after being compressed a specified distance or percentage of the cross section.

For more detailed information, please refer to “Compression Set” on page 46.

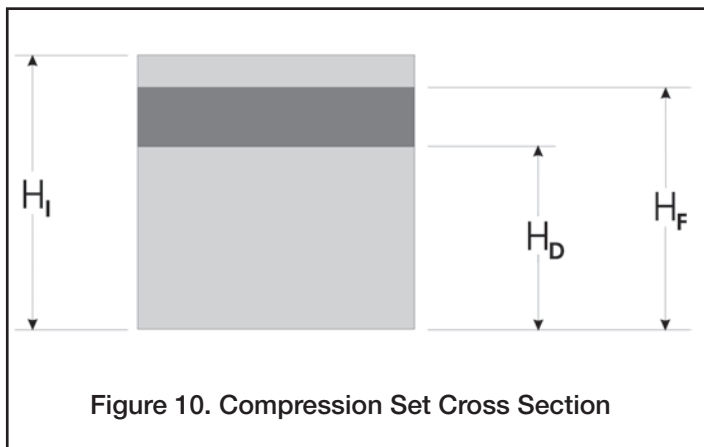

Figure 10. Compression Set Cross Section

- H_I = Original Height
- H_D = Compressed Height
- H_F = Recovered Height
- $H_I - H_F$ = CS = Compression Set (expressed as a percent)

Compression set characteristics vary with each polymer, material formulations within polymer family, the temperature and duration of the test being performed, the thickness of the test specimen, and the cross-sectional geometry of the specimen if part-specific characteristics are being evaluated.

It is suggested that standard ASTM test procedures be followed to establish the initial material characteristics, followed by additional testing of the candidate material with a cross section representing the targeted dimensions, if practical.

Durometer

Hardness, measured in points typically with a Shore A durometer. Determine the best durometer for the application and round off to the nearest 5 (50, 55, 60, etc.). A standard ± 5 point tolerance is applied to permit normal variation in polymer lots and durometer reading methodologies.

Elongation

Evaluate and establish the maximum amount of stretch (measured in percentage) a seal will be exposed to for assembly in the application. Multiply this value by 1.25 to allow a safety factor and to compensate for normal material variation.

Elongation Change

Reported as percentage of original elongation, the guidelines are similar to that of tensile change.

Every designer should establish realistic limits and tolerances based upon past experience in the same or similar application. Excessive hardening, gain in tensile strength and loss of elongation after fluid exposure (immersion) are indications of over aging. Excessive softening, loss of tensile strength and gain of elongation can be indications of reversion (return of the material to its uncured state).

Hardness Change

Reported as point change, this value is usually controlled to avoid excessive softening (causing extrusion into the clearance gap or a loss of seal resiliency) or hardening (causing cracking, lack of resilience, increase in load deflection force or leakage).

Appendix D - Glossary of Material Properties

Low Temperature Resistance

This is established by determining the flexibility of an elastomer at a given low temperature, which should be the lowest temperature the candidate seal material is expected to be exposed to in the application.

The analysis method utilized should be one that most closely simulates the actual application environment. The military version of the Temperature Retraction Test (TR-10) is a suggested method to determine if a seal material can perform effectively at a low temperature.

Most low temperature tests are designed to establish the brittleness point of a material, which only indicates the temperature at which a material most likely will become useless as a seal.

TR-10 evaluations are different. This procedure basically involves stretching 3 to 4 samples 50%, freezing them, warming them up gradually at a constant rate, and recording the temperature at which the samples returned to 9/10 of the original stretch (1/10 return). This temperature (TR-10) represents the lowest temperature at which the compound exhibits rubber-like properties, and therefore can be used to establish the low temperature sealing characteristics.

Tests have indicated that in static applications, solid round cross section profiles can perform satisfactorily to approximately 15°F [-9°C] lower in temperature than the TR-10 value.

Modulus

Select a minimum modulus (measured as tensile strength at a specific amount of elongation, typically 100%) that will assure good extrusion resistance, facilitate the assembly process, and provide good recovery from peak loads.

If the spliced profile is hollow, the amount of force required to stretch the seal will decrease as the internal cross-sectional area increases, providing the outside dimension remains constant. In other words, as the wall thickness (radial) of the profile decreases, the force required to stretch the seal also decreases.

Specific Gravity

A value for specific gravity is typically not established as a criteria for most seal design applications. Instead, the specific gravity for the material selected at the end of the evaluation process can be used for material quality control purposes. If a tolerance for this value is necessary, typically a range of $\pm .03$ is applied.

Tensile Strength

Determine the minimum tensile strength (measured in psi) for the application. Always take into consideration the typical strength of the elastomer that is most likely to be used. Once established, multiply this minimum value by 1.20 (for example: $1,000 \times 1.20 = 1,200$). This now becomes the minimum tensile strength for the application, and provides a buffer for normal compound production batch variation.

Tensile Strength Change

Reported as percentage of original tensile strength, this value is usually established with a reasonable maximum value to insure excessive deterioration and seal failure does not take place. Each fluid and material combination has its own performance characteristics and resultant limitations.

Volume Change

Reported as the percentage increase or decrease in the volume of the test specimen. When the test fluid is air, weight change rather than volume change is typically used. Determine the maximum amount of acceptable swell for the application, which is usually 50% for static sealing applications.

Determine the maximum amount of acceptable shrinkage for the application, which is usually 3 to 4% for static applications. Take into consideration dry-out cycles that may be encountered in service, and include a dry-out test after the fluid immersion test to establish the material performance profile. Bear in mind that shrinkage is a prime cause of seal failure.

Establish the minimum and maximum acceptable volume change value limits for the desired material in each fluid the compound will be exposed to in the application.

Offer of Sale

The items described in this document and other documents and descriptions provided by Parker Hannifin Corporation, its subsidiaries and its authorized distributors ("Seller") are hereby offered for sale at prices to be established by Seller. This offer and its acceptance by any customer ("Buyer") shall be governed by all of the following Terms and Conditions. Buyer's order for any item described in its document, when communicated to Seller verbally, or in writing, shall constitute acceptance of this offer. All goods, services or work described will be referred to as "Products".

1. Terms and Conditions. Seller's willingness to offer Products, or accept an order for Products, to or from Buyer is subject to these Terms and Conditions or any newer version of the terms and conditions found on-line at www.parker.com/saleterms/. Seller objects to any contrary or additional terms or conditions of Buyer's order or any other document issued by Buyer.

2. Price Adjustments; Payments. Prices stated on Seller's quote or other documentation offered by Seller are valid for 30 days, and do not include any sales, use, or other taxes unless specifically stated. Unless otherwise specified by Seller, all prices are F.C.A. Seller's facility (INCOTERMS 2010). Payment is subject to credit approval and is due 30 days from the date of invoice or such other term as required by Seller's Credit Department, after which Buyer shall pay interest on any unpaid invoices at the rate of 1.5% per month or the maximum allowable rate under applicable law.

3. Delivery Dates; Title and Risk; Shipment. All delivery dates are approximate and Seller shall not be responsible for any damages resulting from any delay. Regardless of the manner of shipment, title to any products and risk of loss or damage shall pass to Buyer upon placement of the products with the shipment carrier at Seller's facility. Unless otherwise stated, Seller may exercise its judgment in choosing the carrier and means of delivery. No deferment of shipment at Buyers' request beyond the respective dates indicated will be made except on terms that will indemnify, defend and hold Seller harmless against all loss and additional expense. Buyer shall be responsible for any additional shipping charges incurred by Seller due to Buyer's acts or omissions.

4. Warranty. Seller warrants that the Products sold hereunder shall be free from defects in material or workmanship for a period of twelve months from the date of delivery to Buyer or 2,000 hours of normal use, whichever occurs first. The prices charged for Seller's products are based upon the exclusive limited warranty stated above, and upon the following disclaimer: **DISCLAIMER OF WARRANTY: THIS WARRANTY COMPRISES THE SOLE AND ENTIRE WARRANTY PERTAINING TO PRODUCTS PROVIDED HEREUNDER. SELLER DISCLAIMS ALL OTHER WARRANTIES, EXPRESS AND IMPLIED, INCLUDING DESIGN, MERCHANTABILITY AND FITNESS FOR A PARTICULAR PURPOSE.**

5. Claims; Commencement of Actions. Buyer shall promptly inspect all Products upon delivery. No claims for shortages will be allowed unless reported to the Seller within 10 days of delivery. No other claims against Seller will be allowed unless asserted in writing within 30 days after delivery. Buyer shall notify Seller of any alleged breach of warranty within 30 days after the date the defect is or should have been discovered by Buyer. Any action based upon breach of this agreement or upon any other claim arising out of this sale (other than an action by Seller for an amount due on any invoice) must be commenced within 12 months from the date of the breach without regard to the date breach is discovered.

6. LIMITATION OF LIABILITY. UPON NOTIFICATION, SELLER WILL, AT ITS OPTION, REPAIR OR REPLACE A DEFECTIVE PRODUCT, OR REFUND THE PURCHASE PRICE. **IN NO EVENT SHALL SELLER BE LIABLE TO BUYER FOR ANY SPECIAL, INDIRECT, INCIDENTAL OR CONSEQUENTIAL DAMAGES ARISING OUT OF, OR AS THE RESULT OF, THE SALE, DELIVERY, NON-DELIVERY, SERVICING, USE OR LOSS OF USE OF THE PRODUCTS OR ANY PART THEREOF, OR FOR ANY CHARGES OR EXPENSES OF ANY NATURE INCURRED WITHOUT SELLER'S WRITTEN CONSENT, EVEN IF SELLER HAS BEEN NEGLIGENT, WHETHER IN CONTRACT, TORT OR OTHER LEGAL THEORY. IN NO EVENT SHALL SELLER'S LIABILITY UNDER ANY CLAIM MADE BY BUYER EXCEED THE PURCHASE PRICE OF THE PRODUCTS.**

7. User Responsibility. The user, through its own analysis and testing, is solely responsible for making the final selection of the system and Product and assuring that all performance, endurance, maintenance, safety and warning requirements of the application are met. The user must analyze all aspects of the application and follow applicable industry standards and Product information. If Seller provides Product or system options, the user is responsible for determining that such data and specifications are suitable and sufficient for all applications and reasonably foreseeable uses of the Products or systems.

8. Loss to Buyer's Property. Any designs, tools, patterns, materials, drawings, confidential information or equipment furnished by Buyer or any other items which become Buyer's property, will be considered obsolete and may be destroyed by Seller after two consecutive years have elapsed without Buyer ordering the items manufactured using such property. Seller shall not be responsible for any loss or damage to such property while it is in Seller's possession or control.

9. Special Tooling. A tooling charge may be imposed for any special tooling, including without limitation, dies, fixtures, molds and patterns, acquired to manufacture Products. Such special tooling shall be and remain Seller's property notwithstanding payment of any charges by Buyer. In no event will Buyer acquire any interest in apparatus belonging to Seller which is utilized in the manufacture of the Products, even if such apparatus has been specially converted or adapted for such manufacture and notwithstanding any charges paid by Buyer. Unless otherwise agreed, Seller shall have the right to alter, discard or otherwise dispose of any special tooling or other property in its sole discretion at any time.

10. Buyer's Obligation; Rights of Seller. To secure payment of all sums due or otherwise, Seller shall retain a security interest in the goods delivered and this agreement shall be deemed a Security Agreement under the Uniform Commercial Code. Buyer authorizes Seller as its attorney to execute and file on Buyer's behalf all documents Seller deems necessary to perfect its security interest.

11. Improper use and Indemnity. Buyer shall indemnify, defend, and hold Seller harmless from any claim, liability, damages, lawsuits, and costs (including attorney fees), whether for personal injury, property damage, patent, trademark or copyright infringement or any other claim, brought by or incurred by Buyer, Buyer's employees, or any other person, arising out of: (a) improper selection, improper application or other misuse of Products purchased by Buyer from Seller; (b) any act or omission, negligent or otherwise, of Buyer; (c) Seller's use of patterns, plans, drawings, or specifications furnished by Buyer to manufacture Product; or (d) Buyer's failure to comply with these terms and conditions. Seller shall not indemnify Buyer under any circumstance except as otherwise provided.

12. Cancellations and Changes. Orders shall not be subject to cancellation or change by Buyer for any reason, except with Seller's written consent and upon terms that will indemnify, defend and hold Seller harmless against all direct, incidental and consequential loss or damage. Seller may change product features, specifications, designs and availability with notice to Buyer.

13. Limitation on Assignment. Buyer may not assign its rights or obligations under this agreement without the prior written consent of Seller.

14. Force Majeure. Seller does not assume the risk and shall not be liable for delay or failure to perform any of Seller's obligations by reason of circumstances beyond the reasonable control of Seller (hereinafter "Events of Force Majeure"). Events of Force Majeure shall include without limitation: accidents, strikes or labor disputes, acts of any government or government agency, acts of nature, delays or failures in delivery from carriers or suppliers, shortages of materials, or any other cause beyond Seller's reasonable control.

15. Waiver and Severability. Failure to enforce any provision of this agreement will not waive that provision nor will any such failure prejudice Seller's right to enforce that provision in the future. Invalidation of any provision of this agreement by legislation or other rule of law shall not invalidate any other provision herein. The remaining provisions of this agreement will remain in full force and effect.

16. Termination. Seller may terminate this agreement for any reason and at any time by giving Buyer thirty (30) days written notice of termination. Seller may immediately terminate this agreement, in writing, if Buyer: (a) commits a breach of any provision of this agreement (b) appointments a trustee, receiver or custodian for all or any part of Buyer's property (c) files a petition for relief in bankruptcy on its own behalf, or by a third party (d) makes an assignment for the benefit of creditors, or (e) dissolves or liquidates all or a majority of its assets.

17. Governing Law. This agreement and the sale and delivery of all Products hereunder shall be deemed to have taken place in and shall be governed and construed in accordance with the laws of the State of Ohio, as applicable to contracts executed and wholly performed therein and without regard to conflicts of laws principles. Buyer irrevocably agrees and consents to the exclusive jurisdiction and venue of the courts of Cuyahoga County, Ohio with respect to any dispute, controversy or claim arising out of or relating to this agreement.

18. Indemnity for Infringement of Intellectual Property Rights. Seller shall have no liability for infringement of any patents, trademarks, copyrights, trade dress, trade secrets or similar rights except as provided in this Section. Seller will defend and indemnify Buyer against allegations of infringement of U.S. patents, U.S. trademarks, copyrights, trade dress and trade secrets ("Intellectual Property Rights"). Seller will defend at its expense and will pay the cost of any settlement or damages awarded in an action brought against Buyer based on an allegation that a Product sold pursuant to this Agreement infringes the Intellectual Property Rights of a third party. Seller's obligation to defend and indemnify Buyer is contingent on Buyer notifying Seller within ten (10) days after Buyer becomes aware of such allegations of infringement, and Seller having sole control over the defense of any allegations or actions including all negotiations for settlement or compromise. If a Product is subject to a claim that it infringes the Intellectual Property Rights of a third party, Seller may, at its sole expense and option, procure for Buyer the right to continue using the Product, replace or modify the Product so as to make it noninfringing, or offer to accept return of the Product and return the purchase price less a reasonable allowance for depreciation. Notwithstanding the foregoing, Seller shall have no liability for claims of infringement based on information provided by Buyer, or directed to Products delivered hereunder for which the designs are specified in whole or part by Buyer, or infringements resulting from the modification, combination or use in a system of any Product sold hereunder. The foregoing provisions of this Section shall constitute Seller's sole and exclusive liability and Buyer's sole and exclusive remedy for infringement of Intellectual Property Rights.

19. Entire Agreement. This agreement contains the entire agreement between the Buyer and Seller and constitutes the final, complete and exclusive expression of the terms of sale. All prior or contemporaneous written or oral agreements or negotiations with respect to the subject matter are herein merged.

20. Compliance with Law, U. K. Bribery Act and U.S. Foreign Corrupt Practices Act. Buyer agrees to comply with all applicable laws and regulations, including both those of the United Kingdom and the United States of America, and of the country or countries of the Territory in which Buyer may operate, including without limitation the U. K. Bribery Act, the U.S. Foreign Corrupt Practices Act ("FCPA") and the U.S. Anti-Kickback Act (the "Anti-Kickback Act"), and agrees to indemnify and hold harmless Seller from the consequences of any violation of such provisions by Buyer, its employees or agents. Buyer acknowledges that they are familiar with the provisions of the U. K. Bribery Act, the FCPA and the Anti-Kickback Act, and certifies that Buyer will adhere to the requirements thereof. In particular, Buyer represents and agrees that Buyer shall not make any payment or give anything of value, directly or indirectly to any governmental official, any foreign political party or official thereof, any candidate for foreign political office, or any commercial entity or person, for the purpose of influencing such person to purchase products or otherwise benefit the business of Seller.

Other TechSeal Division Products



Bumpers, isolators and sleeves

TechSeal's precision extruding and cutting technologies offer a wide range of elastomeric and thermoplastic engineered products including sleeves, tubing, bumpers, grips, stoppers, plugs, rollers and a variety of other configurations.



Packer Elements

TechSeal's oil and gas Packer Elements are extruded using advanced grade elastomers, yielding a consistent product without flash, parting lines or molded voids.



Precision Cut seals

Precision cut seals have rectangular cross sections, providing maximum sealing contact area as well as improved gland stability. TechSeal's extruding and cutting processes ensure no flash or parting lines for better application performance. Precision cut seals are available in sizes ranging from .020" to 18.00" I.D.



Specialty Cut Profiles

Specialty cut profiles are available in a variety of configurations including square, D-shaped, chamfered, lipped and many more. Custom configurations are available from as small as 1" up to 18" I.D.



Filter seals

Precision cut outer gaskets and molded anti drain back (ADB) valves and grommets for spin-on oil filters.

Size Offering

TechSeal offers extruded and precision-cut seals from 0.030" up to 18.0" I.D. with walls as thin as 0.010" (depending on O.D.). These seals can be cut into washers and other sealing configurations as thin as 0.030". Other custom extruded profiles can also be supplied in long lengths (with or without PSA), spliced solid / hollow rings and ParFab fabricated multi-corner gaskets.

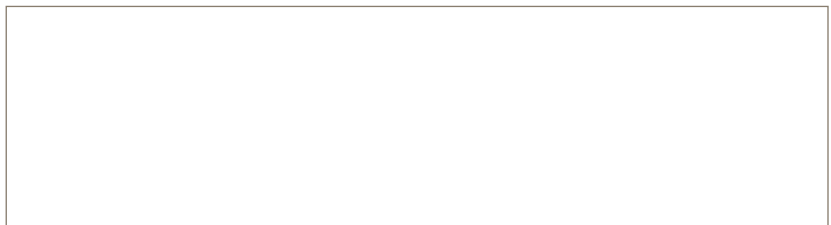

Your Local Authorized Parker Distributor



Parker Hannifin Corporation
O-Ring & Engineered Seals Division
3025 West Croft Circle
Spartanburg, SC 29302
phone 864 573 7332
fax 864 583 4299
www.parker.com/oes