

nobrox[®]

The Thermoplastic Material for
Seals and Engineered Components

aerospace
climate control
electromechanical
filtration
fluid & gas handling
hydraulics
pneumatics
process control
sealing & shielding



ENGINEERING YOUR SUCCESS.



nobroX

A New Material Changes Sealing Technology

Sealing technology rethought with a clear objective: ease of use.

The result: a versatile new material that will fundamentally change and simplify sealing technology!

A New Material with “All-rounder” Potential

Top marks in terms of wear resistance, chemical resistance and resilience, reliability, ease of assembly and economy – while offering versatile uses as a sealing element, guiding element, anti-extrusion element and material for engineered components: Parker’s new nobrox® material combines all of these fortes and more. As a result, it is particularly well suited to meet the specific requirements in the field of

hydraulics, as well as those of many other applications. Being predestined for use as an “all-rounder,” the material marks a distinctive step forward and, not least thanks to the extensive freedom of design it offers, allows completely new avenues to be explored in sealing technology.

A New Material with a Past

nobrox® is a new material, as well as one with a past. Back in 1996, Parker-Prädifa began working

with a predecessor of today’s compound. Due to its outstanding properties it was used, among other things, for rotary seals that have been setting the standard for rotating unions for years.

In nearly 20 years of field testing, Parker-Prädifa was able to demonstrate the material’s suitability for the challenging demands of hydraulic applications. Now, the market launch of nobrox® again confirms Parker-Prädifa’s role of a pioneer in the field of engineered materials.



A New Material with a Future

nobrox[®] is based on a special polyketone (PK). Parker-Prädifa previously focused on using the material for rotor seals with extremely high load profiles. Now, the advantage of long-standing experience in working with the original material has been used as the basis for its further development. Compared with its predecessor, the new Parker material is characterized by further improvements of the impressive performance profile that even the earlier version had exhibited. Clearly less costly than PEEK, nobrox[®] might be referred to as “PEEK light.” As such, nobrox[®] offers similarly outstanding benefits as PEEK, a material that has been equally known for high performance and relatively high cost.

A New Material with an Eco-Friendly Footprint

nobrox[®] not only marks a major step forward in terms of sealing technology and engineered materials but also with respect to environmental friendliness. The production of the polyketone requires carbon monoxide (CO). In the manufacturing process of PK, this highly toxic and environmentally harmful industrial waste gas is permanently transformed as a major component of the polymer chain, which prevents its emission to the environment.

Furthermore, the higher reliability and service life of nobrox[®] resulting from its high wear resistance are positively reflected in its environmental footprint.

Benefits at a Glance

- Wide application range
 - In sealing technology: as a sealing element, guiding element, anti-extrusion element, diaphragm, ...
 - Outside sealing technology: as a material for engineered components
- Extremely wear-resistant
- Robust against abrasive particles, rough surfaces, etc.
- Robust and simplified assembly
- High resilience (“snappiness”)
- Resistant against conventionally used media in fluid power applications
- Resistant against water, moisture and other polar media
- Cost-efficient
- Eco-friendly

Exceptional Performance in any Discipline

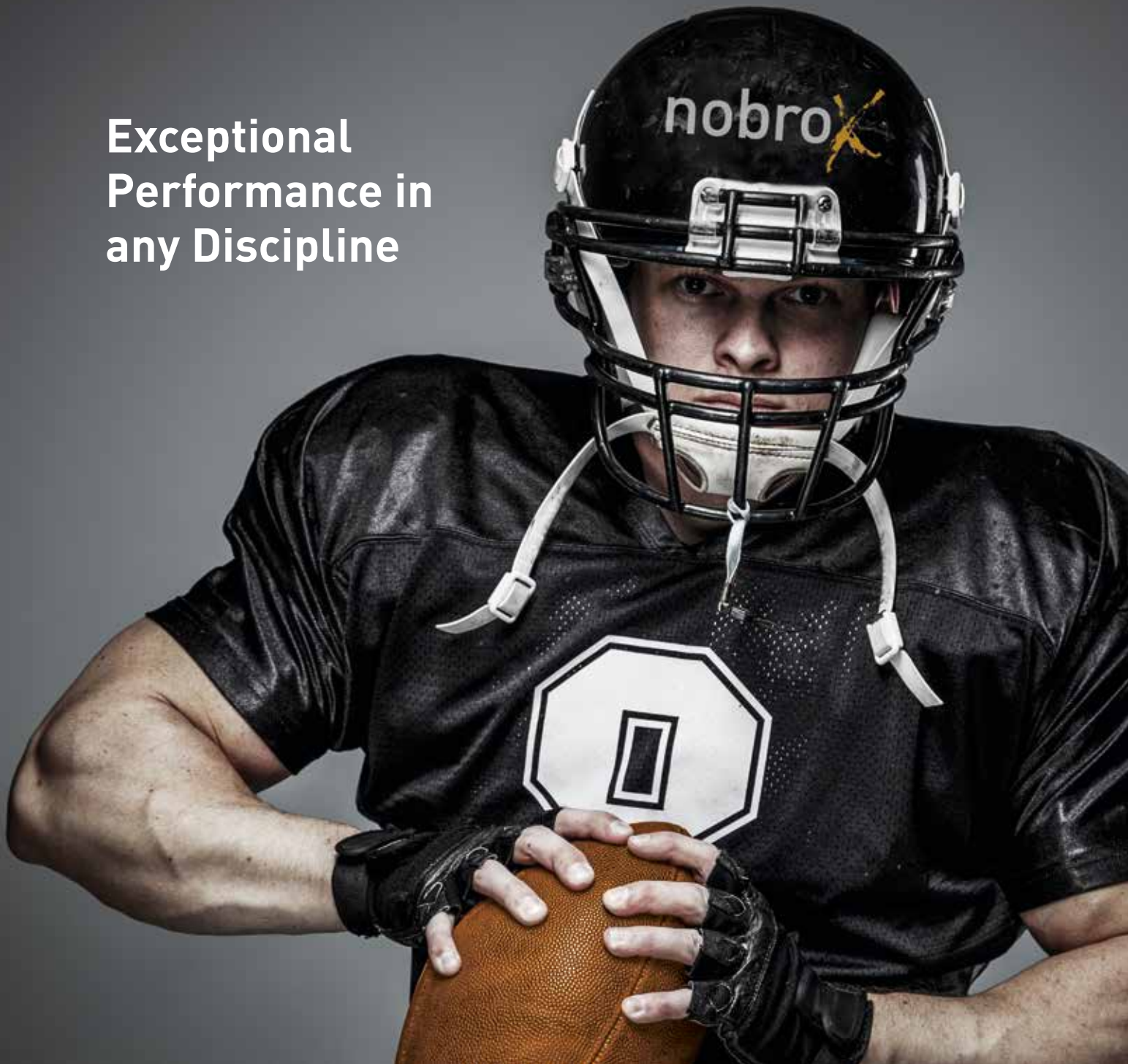

Robust and Reliable in the Long Run

Component reliability, long service life and economy are high on the wish list of users for obvious reasons. nobrox® enables robust sealing solutions and engineered components for hydraulic applications that uniquely meet these wishes while making less exacting demands on the surrounding components than solutions using other materials. Even costly precise gap dimensions are not required.

Perfectly at Ease with High Loads

Hydraulic systems – be they stationary or mobile – typically perform heavy-duty work of lifting, digging, building, hauling, moving, etc. Any of these activities involve high loads which the materials used in even the smallest components such as seals and guides have to withstand. Parker's nobrox® material is a master of sturdiness that will not deform under loading. This forte also provides options

for component miniaturization, which means that smaller sealing elements can be used in the same load conditions. In addition, nobrox® is characterized by exceptional “snappiness,” also known as spontaneous elasticity with highly dynamic resilience.

Standing Tall in the Face of Adversity

In the harsh working conditions of hydraulic systems, sealing materials – besides withstanding high loads and pressures – must

be able to successfully resist a variety of other attacks. Environments contaminated by abrasive particles, as well as rough surfaces, mechanically attack the materials, while fluids do so by chemical means. Pressure and temperature contribute their fair share to these challenges. Seals made of the new Parker nobrox® material excel in terms of robustness against abrasion even on the harshest mating surfaces such as castings, drawn tubes or ceramics. And of course they are compatible with all media commonly used in fluid power systems at the required operating temperatures as well. With their resistance against water and polar media any moisture absorption is hardly measurable and therefore excludes the risk of undesirable swelling.

Friendly to Designers, Mechanics and Budgets

Seals and engineered components made of nobrox® are manufactured in a very cost-efficient production process. Its cost benefits are reflected in a very good cost-benefit ratio for the customer as well. The benefits are even greater as the new design opportunities and freedoms offered by nobrox® as a material “all-rounder” are also available at attractive prices.

The new Parker material not only proves its elasticity in terms of price, wide application range and performance but also when it comes to robust assembly: thanks to this outstanding property the installation of nobrox® components and seals is literally a snap, thus saving time and costs.

Globally Operating Process Partner

The material is one thing and its conversion into reliable large-volume products another. As part of the worldwide Parker Engineered Materials Group Parker-Prädifa as an expert in process engineering and design has both the engineered materials and design expertise to achieve advanced solutions for seals and engineered components. Like all Parker-Prädifa materials, the new nobrox® compound is precisely adapted to the customer’s specific requirements such as friction and temperature conditions, as well as media resistance.

Advantage from Two Decades of Field Experience with Polyketone

Thanks to drawing on a nearly 20-year advantage in using polyketone and the resulting field experience Parker-Prädifa on launching nobrox® now offers customers the opportunity to make use of the myriad benefits of this new “all-rounder” practically from a standing start. So, take us at our word and join us in moving forward into new dimensions of sealing technology.



Material Monograph

- **Definition**
Polyketone
- **Ecology**
 - Raw material: carbon monoxide from coal combustion
 - Extended lifecycles
 - Reliable operation
- **Mechanical Properties**
 - Mechanical and thermal base values at the level of PA 6 grades
 - Low water absorption, very good dimensional stability
 - Very good hydrolysis stability
 - Extreme abrasion resistance
 - High resilience
 - Stable against oxidation attacks up to 150 °C
- **Chemical Resistance**
 - Hydrocarbons (mineral oils, gasoline)
 - Synthetic esters (HEES)
 - Aldehydes
 - Water, weak acids (vinegar) and weak bases (ammonia)
- **Barrier Properties**
 - Oxygen permeation rate smaller than PA 6 by a factor of 4, smaller than POM by a factor of 8
 - Gasoline permeation (GM Spec 9061-P) lower than PTFE and PA 12
- **Approvals**
 - Food and drinking water approvals in preparation

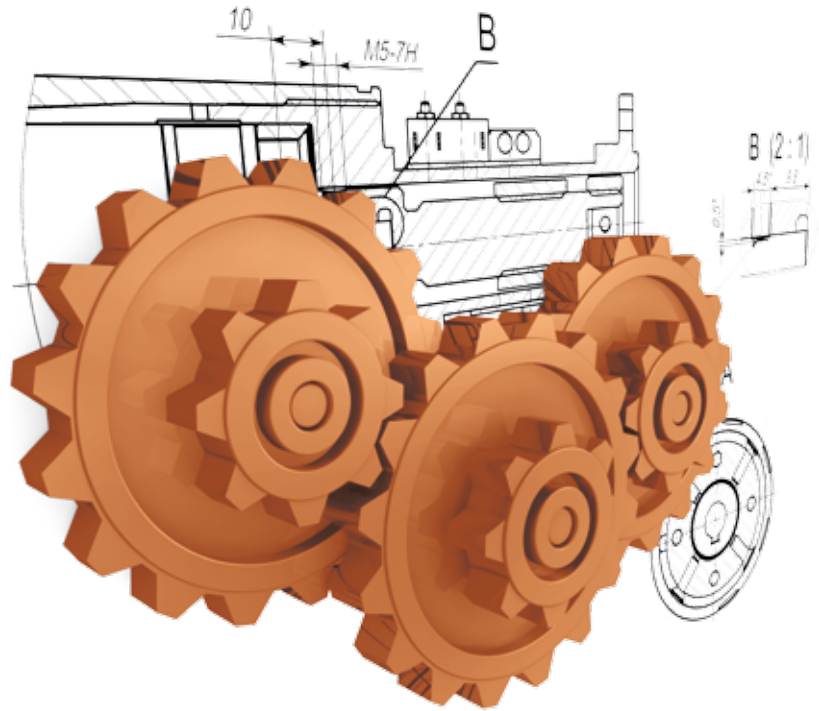

nobrox® as an Engineering Material

Today, designers of machines, systems, functional assemblies and industrial or consumer goods of any description can choose from a tremendous range of materials to design their products. Thanks to the powerful innovations achieved by materials science and process engineering this range keeps growing at a steady pace.

Parker's new nobrox® material is a fine example of these continual innovations. It belongs to the group of polyketones (PK). Due to its outstanding properties the material, in addition to its versatile uses in sealing technology, is also superbly suited for utilization as an engineering material for all types of industrial and consumer goods.

Due to its technical properties it is safe to assume that nobrox® will be able to win against polyamide in many applications. Based on its outstanding permeation properties its utilization for fuel tanks in passenger cars or diaphragms in fuel systems or pressure sensors is conceivable. In addition, approvals for use in drinking water or contact with foodstuffs are currently in preparation. As a result, nobrox® will also provide an alternative to polyethylene and be suitable for engineered components in appliances such as coffee machines.

With its outstanding permeation properties and suitability for contact with foodstuffs nobrox® combines two essential properties that provide a remarkably wide range of uses for engineered components made of this material.

A large industrial hydraulic system is shown in a clean, brightly lit environment. The system consists of several tall, cylindrical stainless steel tanks or cylinders connected by a network of pipes and valves. A central control panel with a digital display and several buttons is mounted on a metal frame. The background shows a white ceiling with recessed lighting and a ventilation grille.

Fields of Application

Mobile Hydraulics

- Earth moving/construction
- Mounted implements/attachments
- Trucks
- Cranes
- Agricultural and forestry equipment
- Rail technology
- Airport ramps
- Hydraulic components for oil drilling

Industrial Hydraulics

- Elevators and lifting platforms
- Process industry
- Machines

Automotive Industry

- Cooling systems
- Shock absorbers
- AdBlue®

Chemical Process Industry

- Food and beverage industry
- Pharmaceutical production

Consumer Goods

- Power tools
- Facility engineering
- Household appliances
- Outdoor equipment
- And much more



nobrox[®] Put to the Proof:

Demonstrably Outstanding Properties Profile

There are two key factors which are particularly important when seals are intended for use in hydraulic applications: robustness against abrasive particles that can act on the systems from the outside and high pressure and extrusion resistance. Ultimately, robustness against all kinds of stress and loads increases the reliability of the sealing systems and allows longer seal life to be achieved. The utilization of seals made of nobrox[®] simplifies the design of the hydraulic

system as the material makes less exacting demands on the surrounding components than say PTFE compounds. As a result, larger radial gaps behind the seal or slightly higher roughness values for the seals' mating surfaces are possible, for example.

The diagram depicts the key functionalities for hydraulic sealing applications in a quantitative



and qualitative comparison with other relevant materials.

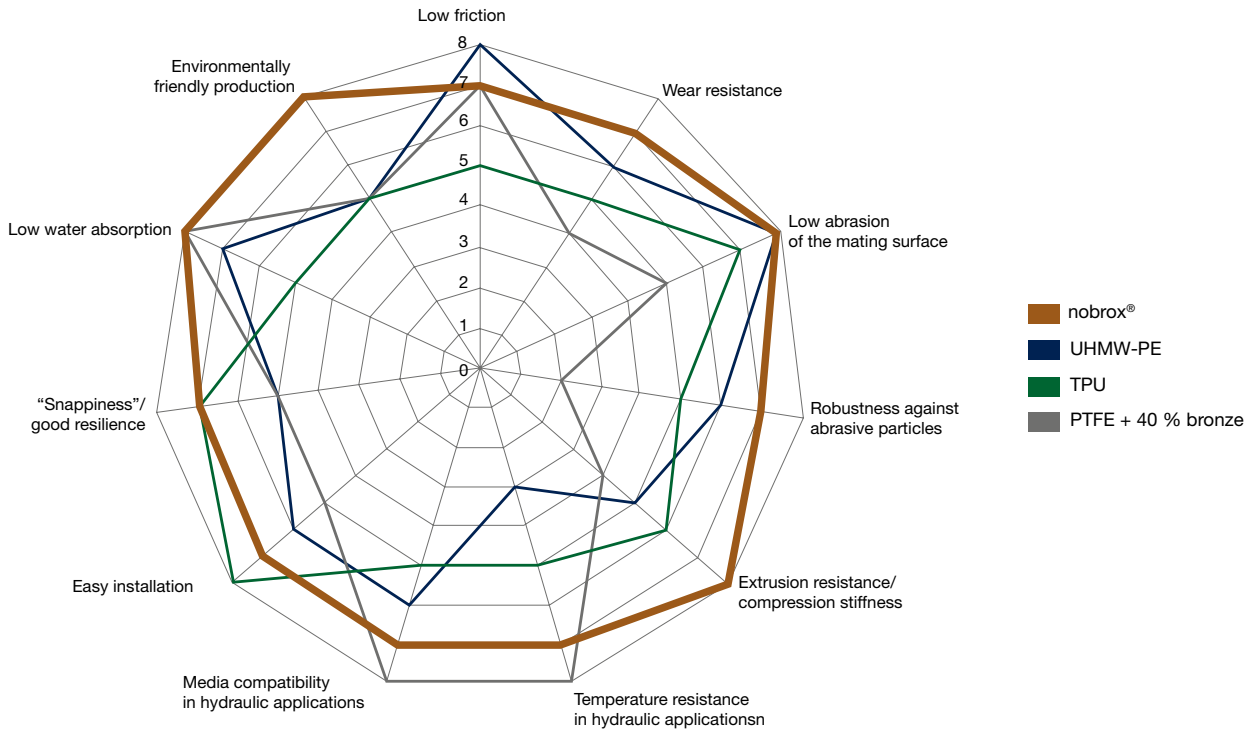

Wear and Extrusion Resistance

For maximum service life in hydraulic applications, a sealing material should exhibit high wear resistance even in the most adverse conditions such as running on ceramic mating surfaces, cast-

ings or drawn tubes. In addition, the sealing material should be insensitive to abrasive particles that might deposit in the contact areas during the operation of the seals. Ideally, a sealing material

should even be able to smooth the mating surface over time with only minimal wear occurring to the material itself and without causing any damage to the other components involved.

Extrusion Tendency

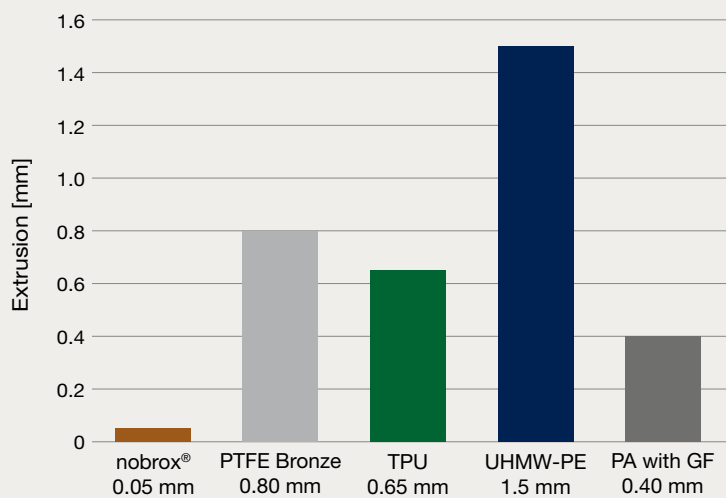

Test Conditions

Piston seals \varnothing 100 mm
(300 bar, 72 h, 80 °C, radial gap 0.5 mm)

The extrusion behavior of new sealing materials is determined, for example, by using rectangular piston seals or standard rings. When using this method extrusion occurs as a result of the specified loadings and the radial gap behind the seal. It can be measured as a permanent plastic deformation resulting from the intrusion of the material into the radial gap under the applied load.

Deformation under Load

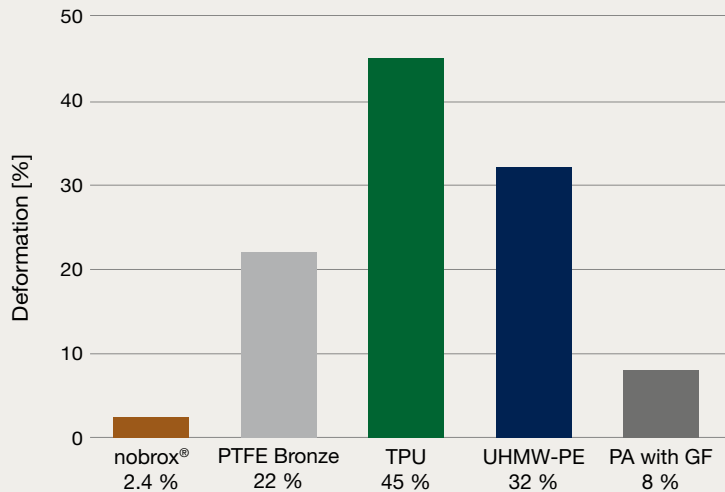

Test Conditions

Samples Ø16 x 10 mm
(14 MPa, 24 h, 100 °C)

The deformation of materials under load is determined by a method which is oriented to an ASTM standard. A cylindrical test piece with a dimension of Ø16 x 10 mm is subjected to a defined load (14 MPa for example) and the dimensional changes of the test pieces are determined, depending on temperature and test duration. The results make it possible to evaluate materials with respect to the deformation behavior of seals in hydraulic applications.

Wear

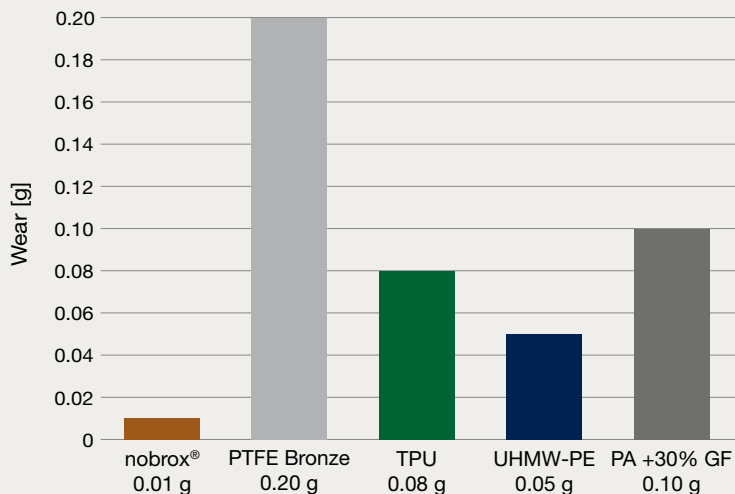

Test Conditions

Cylindrical test pieces
(14 N/mm², 0.1 m/s, 100,000 load reversals, room temperature, oil-lubricated)

The wear resistance of materials is investigated on axial tribo testers. A cylindrical test piece with a dimension of Ø16 x 10 mm is subjected to a load of 14 MPa and a defined sliding velocity. Wear is determined as weight loss on the test pieces, depending on travel speed, load reversal time and roughness of the mating surface. The results make it possible to evaluate materials with respect to the wear behavior of seals in hydraulic applications.

Resilience

The resilience of a material under changing loads is another key characteristic with respect to dynamic applications. A seal must be able to quickly follow the deflection of the rod without loss of contact. nobrox® exhibits exceptionally good resilience, which not only makes the material ideally suited for use as a sealing compound in dynamic applications but considerably simplifies installation and eliminates the need for subsequent calibration.

Assembly

Due to the high elasticity of the material seals made of nobrox® do not have to be calibrated after

installation in the grooves. Thanks to the material's equally high resilience users can easily perform even kidney-shaped installations of seals.

Dynamic Behavior

The dynamic mechanical analysis (DMA) method enables the determination of the "delta" phase shift which describes the difference between deflection and response (recovery) when a sine-shaped mechanical load is applied to the

material sample. The smaller the "delta," the faster the response to the applied deflection, in other words the faster the seal will follow a deflected rod. Therefore, materials with a small "delta" should preferably be used.



Phase Shift

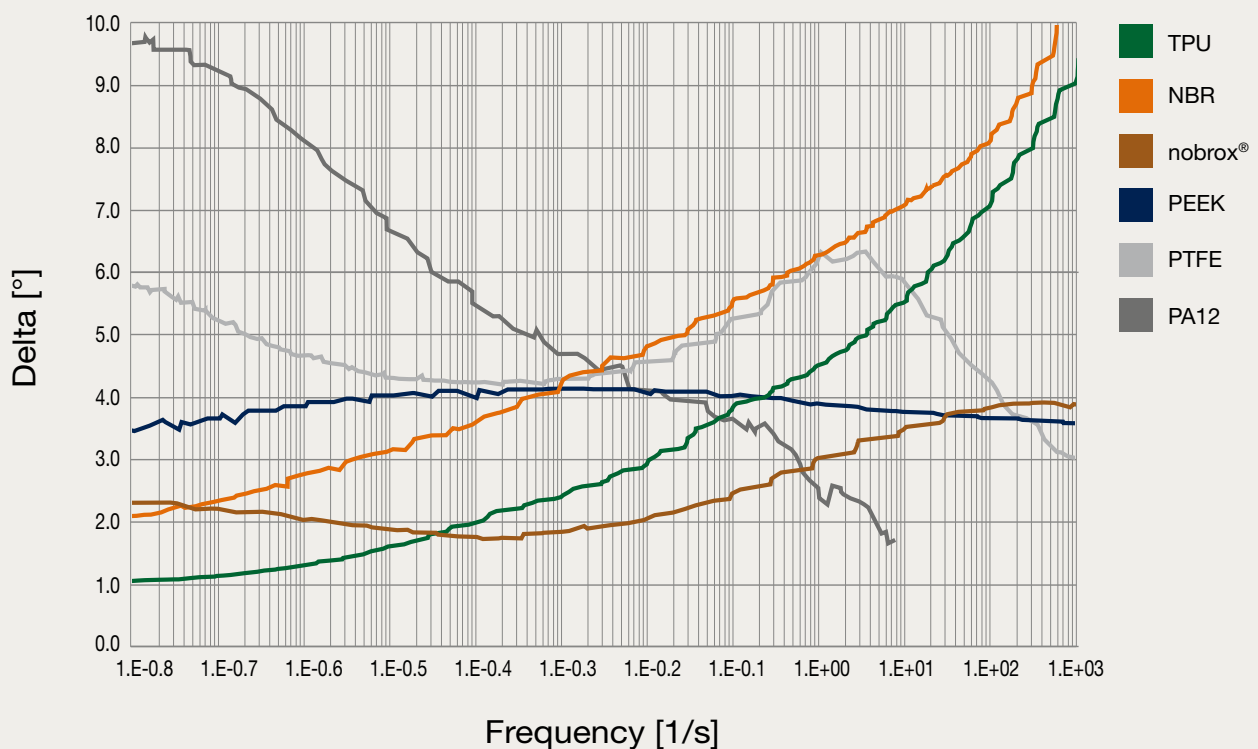

Phase shift curve above the excitation frequency of typical sealing materials.

Friction Behavior

In friction investigations nobrox® was tested on the example of the Profile R1 rod seal under the following conditions:

Conditions	Dimension	Test Parameters
Rod diameter (hard-chrome plated)	mm	36
Stroke length	mm	200
Medium		HLP 46
Operating pressure	bar	0 / 50 / 100 / 150 / 200 / 250 / 300
Operating temperature	°C	30 / 60 / 80
Sliding velocity	m/s	0.01 / 0.02 / 0.05 / 0.1 / 0.15 / 0.2 / 0.25

Test conditions in friction force tests

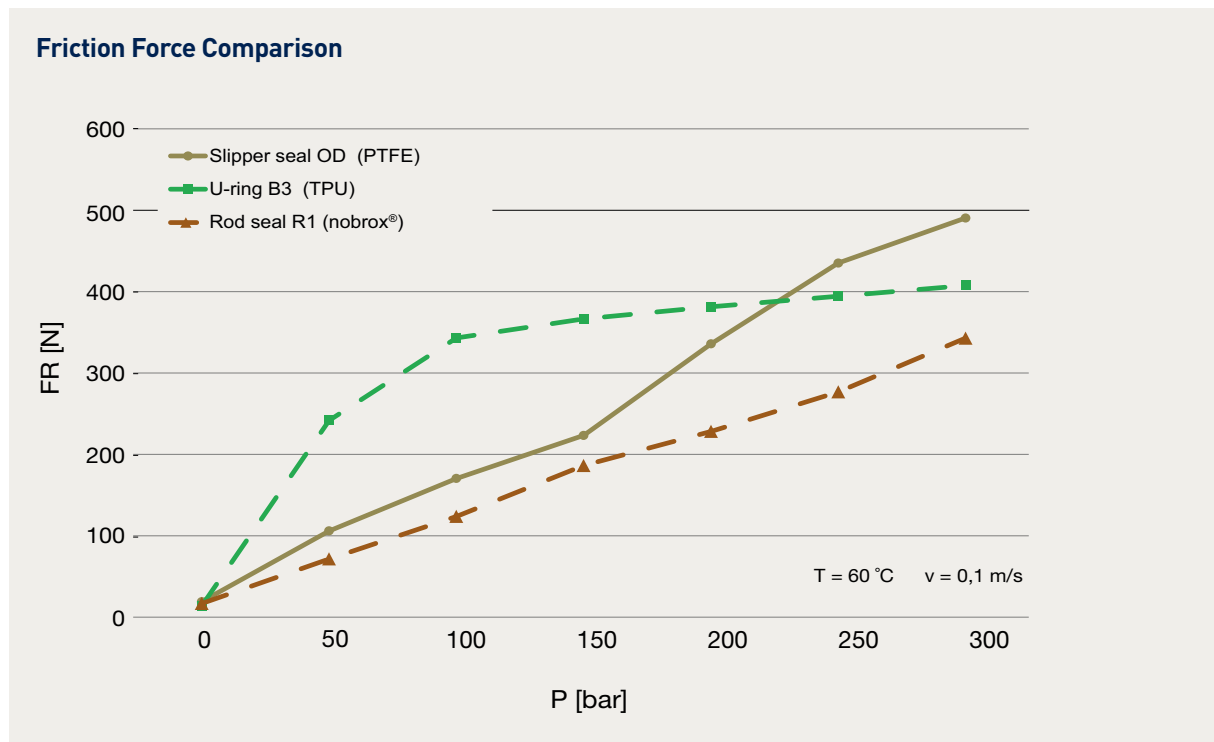

Friction of rod seals depending on pressure, temperature and piston rod speed

The diagram depicts a typical result of a friction force test with various seal profiles and materials tested. In non-pressurized conditions, all the seal designs under test exhibit a similar level of friction. While in the case of a polyurethane U-ring friction initially increases significantly as pressure rises and the friction

curve subsequently levels off, the friction behavior of the tested slipper seals, depending on pressure, is almost linear. Depending on the specified test conditions and the lubrication film on the hard-chrome plated piston rod that is generated in the process, the friction differences between the individual seal designs and

materials may vary. Under low pressures, the sealing rings made of nobrox® and a PTFE compound exhibited more or less identical friction behavior. However, with increasing pressure loads acting on the seal the new nobrox® increasingly displayed its advantages.

Media Resistance

The outstanding media resistance of nobrox® was demonstrated in relevant tests as well. Only minor changes in mechanical characteristics were noted in storage tests in hydrocarbons

(oils, gasoline,...), synthetic esters (HEES), aldehydes or water (see chart). Especially in the case of typical hydraulic media, there is no significant degradation and, in the worst

case, minor swelling – in contrast to the swelling tendency of PA. The minor water absorption results in higher dimensional stability, which allows guides with tighter fit to be achieved.

Test	Dimension	IRM 901 1000 h 80 °C		Wasser 168 h 100 °C	
		PA 6.6	nobrox®	PA 6.6	nobrox®
Hardness	Shore D	2.0	2.0	-14.0	-3.0
Yield stress	%	4.2	23.1	-51.0	7.5
Yield strain	%	50.0	-28.6	383.3	14.3
Volume change	%	0.2	0.3	7.1	3.9

Change in properties due to ageing in the medium

Temperature Behavior

The mechanical strength of a material is tested by means of the tensile test according to DIN 53504. At room temperature, a more uniform stress-strain curve can be noted with nobrox®

in comparison to a polyamide (PA6.6). With increasing deformation, the softening of the new material occurs at a much slower pace and there is no sudden drop in stiffness or stress whitening

tendency detectable either. Consequently, this behavior of the material results in easier installation of the seals in the housings.

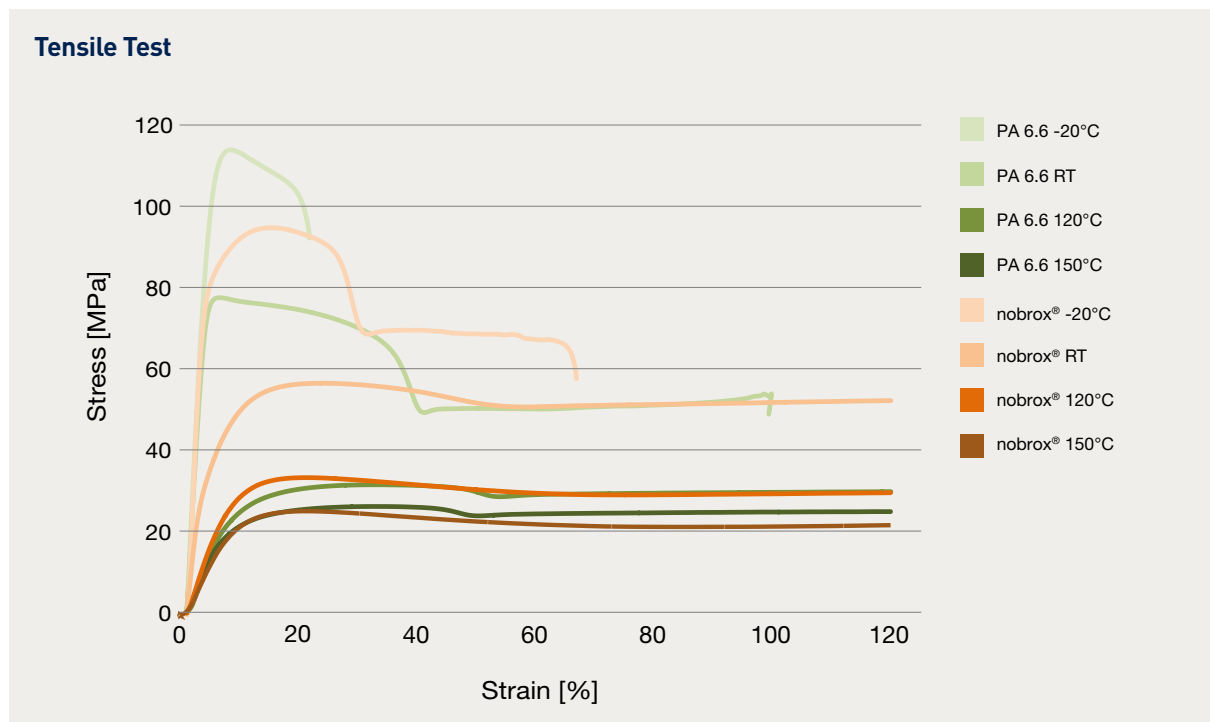

Comparison of the mechanical properties of nobrox® in comparison to polyamides, depending on temperature (-20 °C to +150 °C)

Wide Range of Application in and outside Sealing Technology

With its outstanding properties profile nobrox® is extremely versatile: as a sealing element, guiding element and anti-extrusion element in sealing technology. Furthermore, the material is superbly suited for use in a wide range of engineered components.

Product Examples:

Slipper Seals

- Robustness/reliability (insensitive to contamination by abrasive particles, e.g. in earth moving equipment)
- Long life (excellent wear characteristics in contact with mating surfaces)
- Ease of assembly (flexibility, resilience, “snappiness,” elasticity)
- Media compatibility with hydraulic oils and resistance against moisture/hydrolysis resistance
- Chemical resistance against cleaning agents
- Weather resistance
- UV stability
- Resistance against dirt adhesion

Anti-Extrusion Rings

- Compressive strength
- High media resistance
- Ease of assembly due to high elasticity
- Higher strength than TPE

Thin-Walled Diaphragms

- Fatigue strength
- Barrier properties, high permeation density
- Media compatibility
- Thin wall thicknesses (thermoforming/embossing)



Guiding Elements

- Compressive strength corresponding to polyamide
- No absorption of water. Swelling and resultant excessive friction are prevented (in contrast to water-absorbing polyamide), shape and dimensional stability are ensured
- Robustness/reliability (e.g. in contact with abrasive particles in earth moving equipment)
- Long life (excellent wear characteristics in contact with mating surfaces)
- Ease of assembly (flexibility, resilience , “snappiness,” elasticity)
- Media compatibility with hydraulic oils and resistance against moisture/hydrolysis resistance
- Cost-efficient (material and manufacturing process, injection molding versus mechanical processing by machining)

Rotor Seals

- Robustness
- Long life
- Excellent sealing performance in non-pressurized conditions
- Robust seal profile for harshest operating conditions
- Extremely high wear resistance
- Long “mileage” thanks to application-optimized material properties
- Insensitive to pressure peaks
- Improved lubrication due to deposit of pressure medium in dynamic contact area
- Maximum extrusion resistance
- Assembly in closed and undercut housings possible

Slipper Seals

- Robustness/reliability (insensitive to contamination by abrasive particles, e.g. in earth moving equipment)
- Long life (excellent wear characteristics in contact with mating surfaces)
- Ease of assembly (flexibility, resilience , “snappiness,” elasticity)
- Media compatibility with hydraulic oils and resistance against moisture/hydrolysis resistance

Physical Data

Test	Standard	Dimension	nobrox® W6100
Elastomer base			PK
Color			Orange brown
Hardness	DIN 53505	Shore D	76
Tensile strength	ISO 527	MPa	60
Ultimate elongation	ISO 527	%	300
Water absorption at 50% rel. humidity	ASTM D 570	%	< 0.5
Izod notched impact strength	ISO 180/1A	kJ/m ²	15
Tensile modulus	ISO 527	GPa	1.2